



PAR30L LED Single Optic lamp with AirFlux Technology

12PAR30L/F25 4000 DIM AF SO 6/1

Philips PAR30L LED Retail Optic lamp with AirFlux Technology improves shopping experience with superior lighting aesthetics and optimal thermal efficiency in a sleek, lightweight design.

Product data

• General Characteristics

Cap-Base	E26
Bulb	PAR30L
Rated Avg. Life (Hours)	50000 hr

• Light Technical Characteristics

Color Code	WH
Color Designation	White
Beam Angle	25 D
Beam Description	25D [Medium beam]
Correlated Color Temperature	4000 K
Approximate Lumens	950 Lm
Approx. MBCP	5500 cd
CRI	82
Luminous Efficacy Lamp	79.17 Lm/W
Color Temp. (Kelvin)	4000 K [CCT 4000K]
Rated Luminous Flux	950 Lm

• Electrical Characteristics

Wattage	12 W
Wattage Technical	12 W
Voltage	120 V
Line Frequency	60 Hz
Power Factor	0.9 -
Lamp Current mA	113 mA

Dimmable	Yes
Wattage Equivalent	75 W
Starting Time	0.5 s

• Environmental characteristics

Energy consumption kWh/1000h	12 kWh
------------------------------	--------

• Measuring Conditions

Switching cycle	20000X
-----------------	--------

• Product Dimensions

Overall Length C	116 mm
Diameter D	92 mm

• Product Data

Product number	430140
Full product name	12PAR30L/F25 4000 DIM AF SO 6/1
Short product name	12PAR30L/F25 4000 DIM AF RO 6/1
Pieces per Sku	1
eop_pck_cfg	6
Skus/Case	6
Bar code on pack	46677430146
Bar code on case	50046677430141
Logistics code(s)	929000251504
eop_net_weight_pp	0.240 kg



PHILIPS

PAR30L LED Single Optic lamp with AirFlux Technology

Warnings and Safety

- Suitable for use in damp locations.
- Not for use in totally enclosed luminaires.

- Before replacing, turn off power and let lamp cool to avoid electrical shock or burn.

Dimensional drawing

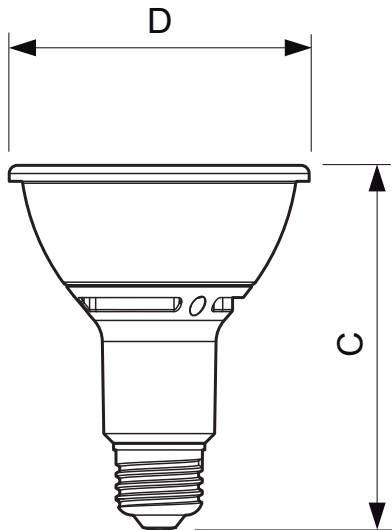

E26

12PAR30L/F25 4000 DIM AF SO 6/1

Product	C (Norm)	C1 (Max)	D (Norm)	D1 (Norm)
LED 12-75W E26 4000K 120V PAR30L 25D DIM	116	-	92	-



© 2014 Koninklijke Philips N.V. (Royal Philips)
All rights reserved.

Specifications are subject to change without notice. Trademarks are the property of Koninklijke Philips N.V. (Royal Philips) or their respective owners.

www.philips.com/lighting

2014, November 18
data subject to change