

## FEATURES & SPECIFICATIONS

**INTENDED USE** — The VT Series Volumetric LED Troffer (VTL) combines the aesthetics and high performance with intelligent LED engines for applications such as offices, schools, retail locations and hospitals. High-efficacy light engines deliver long life and excellent color, ensuring a superior quality lighting installation that is highly efficient and sustainable. Multiple lumen packages and driver options provide solutions for all your lighting applications. Featured nLight control system provides design flexibility and ease of installation and optimum energy savings.

**CONSTRUCTION** — Rugged, one-piece cold-rolled steel coated polyester, painted after fabrication with embossed facets. Impact-modified, single clear acrylic diffuser provides excellent shielding and wide distribution. End plates include integral T-bar clips. Fixture may be mounted and wired in continuous rows. Total fixture height is only 4-3/8".

**OPTICS** — Volumetric illumination is achieved by creating an optimal mix of light to walls, partitions, vertical and horizontal work surfaces — rendering the interior space, objects and occupants in a more balanced, complementary luminous environment. Linear faceted reflector cavity softens and distributes light into the space while minimizing luminous contrast between the fixture and ceiling. Sloped end plates provide a smooth, luminous transition between fixture and ceiling while enhancing the perception of fixture depth. High-performance diffuser provides LED concealment, even illumination across the diffuser and improved lumen-per-watt performance.

Now available with two different aesthetics including the standard Acrylic Linear Prismatic Diffuser (**ADP**) and the Acrylic Linear Prismatic Diffuser with Diffuser Trim Rings (**ADPT**).

**ELECTRICAL** — Long-life LEDs, coupled with high-efficiency drivers, provide superior quantity and quality of illumination for extended service life. 80% LED lumen maintenance at 60,000 hours (L80/60,000).

eldoLED driver options deliver choice of dimming range, and choices for control, while assuring flicker-free, low-current inrush, 89% efficiency and low EMI.

Optional integrated nLight® controls make each luminaire addressable, allowing them to digitally communicate with other nLight enabled controls such as dimmers, switches, nLight AIR RIO, RES7 occupancy sensors, and photocontrols. Simply connect all the nLight enabled control devices and the VTLed luminaires using standard Cat-5 cabling, or the nLight AIR wireless network. Unique plug-and-play convenience allows devices and luminaires to automatically discover each other and self-commission.

Lumen Management: Unique lumen management system (option N80) provides on board intelligence that actively manages the LED light source so that constant lumen output is maintained over the system life, preventing the energy waste created by the traditional practice of over-lighting.

Step-level dimming option allows system to be switched to 50% power for compliance with common energy codes while maintaining fixture appearance.

Driver disconnect provided where required to comply with US and Canadian codes.

**SENSOR — Integrated sensor (individual control):** Sensor Switch MSD7ADCX (Passive infrared (PIR)) or MSDPD77ADCX (PIR/Microphonics Dual Tech (PDT)) integrated occupancy sensor/automatic dimming photocell allows the luminaire to power off when the space is unoccupied or enough ambient light is entering the space. See page 2 for more details on the integrated sensor.

**Integrated Sensor (nLight Wired Networking):** This sensor is nLight-enabled, meaning it has the ability to communicate over an nLight network. When wired, using CAT-5 cabling, with other nLight-enabled sensors, power packs, or WallPods, an nLight control zone is created. Once linked to a Gateway, directly or via a Bridge, the zone becomes capable of remote status monitoring and control via SensorView software. See page 2 for the nLight sensor options.

**Integrated Smart Sensor (nLight Air Wireless Platform):** The RES7 sensor is nLight AIR enabled, meaning it has the ability to communicate over the wireless nLight control platform. It is available with an automatic dimming photocell, and either a digital PIR microphonics dual technology (PDT) occupancy sensor. It pairs to other luminaires and wall switches through our mobile app, CLAIRITY, which allows for simple sensor adjustment. See page 4 for more details on the Integrated Smart Sensor.

**INSTALLATION** — Unique grid interfacing arrangement provides mounting into standard 1" and 9/16" tee bar or screw slot grids. 9/16" allows fixture trim to hang level with architectural ceiling tiles. Drywall ceiling adaptors available. Suitable for damp location.

**LISTINGS** — CSA Certified to meet U.S. and Canadian standards. IC rated. DesignLights Consortium® (DLC) Premium qualified product. Not all versions of this product may be DLC Premium qualified. Please check the DLC Qualified Products List at [www.designlights.org/QPL](http://www.designlights.org/QPL) to confirm which versions are qualified.

**BUY AMERICAN** — Product with the BAA option is assembled in the USA and meets the Buy America(n) government procurement requirements under FAR, DFARS and DOT. Please refer to [www.acuitybrands.com/buy-american](http://www.acuitybrands.com/buy-american) for additional information.

**WARRANTY** — 5-year limited warranty. Complete warranty terms located at: [www.acuitybrands.com/support/customer-support/terms-and-conditions](http://www.acuitybrands.com/support/customer-support/terms-and-conditions)

**NOTE:** Actual performance may differ as a result of end-user environment and application. A generational electronics upgrade occurred in May 2019. The upgraded VT series LED troffer has a slight visual variation from previous generations.

All values are design or typical values, measured under laboratory conditions at 25 °C. Specifications subject to change without notice.

Catalog Number
Notes
Type

### VT Series Volumetric LED Troffer

# 2VTL2

2' x 2'  
LED



## Dimensions

All dimensions are inches (centimeters) unless otherwise specified.

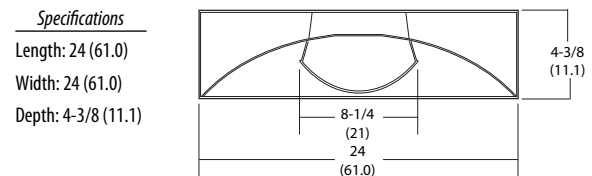

## CSA+ Capable Luminaire

This item is an A+ capable luminaire, which has been designed and tested to provide consistent color appearance and out-of-the-box control compatibility with simple commissioning.

- All configurations of this luminaire meet the Acuity Brands' specification for chromatic consistency
- This luminaire is part of an A+ Certified solution for nLight® or XPoint™ Wireless control networks when ordered with drivers marked by a shaded background\*

To learn more about A+, visit [www.acuitybrands.com/aplus](http://www.acuitybrands.com/aplus).

\*See ordering tree for details

# 2VTL Volumetric Recessed Lighting 2'x2'

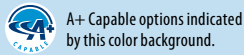

## ORDERING INFORMATION

Lead times will vary depending on options selected. Consult with your sales representative.

**Example:** 2VTL2 40L ADPT EZ1 LP840 MSD7ADCX

2VTL2						
Series	Air function	Lumens <sup>1</sup>	Diffuser	Voltage	Driver	Color temperature
2VTL2 2X2 VTL	(blank) Static H Heat removal	20L 2000 lumens 33L 3300 lumens 40L 4000 lumens 48L 4800 lumens 60L 6000 lumens <sup>2</sup> 72L 7200 lumens <sup>2</sup>	ADP Acrylic linear prismatic ADPT Acrylic linear prismatic with diffuser trim rings	(blank) MVOLT 347 347V <sup>3</sup>	EZ1 eldoLED dims to 1%, 0-10V EZB eldoLED dims to 0.1%, 0-10V GZ1 Dims to 1% (0-10V dimming) <sup>4</sup> GZ10 Dims to 10% (0-10V dimming) <sup>4</sup> EDB eldoLED DALI <sup>5</sup> SLD Step-level dimming <sup>5</sup>	LP830 3000 K, 80 CRI LP835 3500 K, 80 CRI LP840 4000 K, 80 CRI LP850 5000 K, 80 CRI LP930 3000 K, 90 CRI LP935 3500 K, 90 CRI LP940 4000 K, 90 CRI LP950 5000 K, 90 CRI

nLight Interface	Control	Options
<b>nLight Wired</b> (blank) No nLight® interface N80 nLight® with 80% lumen management N80EMG nLight® with 80% lumen management. For use with generator supply EM power <sup>6</sup> N100 nLight® without lumen management N100EMG nLight® without lumen management. For use with generator supply EM power <sup>6</sup> <b>nLight Wireless</b> (blank) No nLight® interface NLTAIR2 nLight® Air Generation 2 enabled <sup>7,8</sup>	<b>nLight Wired</b> (blank) No nLight control NES7 nLight® nES 7 PIR integral occupancy sensor <sup>8,9</sup> NESPDT7 nLight® nES PDT 7 dual technology integral occupancy control <sup>8,9</sup> NES7ADCX nLight® nES 7 ADCX PIR integral occupancy sensor with automatic dimming photocell <sup>8,9</sup> NESPDT7ADCX nLight® nES PDT 7 dual technology integral occupancy sensor with automatic dimming photocell <sup>8,9</sup> <b>nLight Wireless</b> (blank) No nLight control RES7 nLight® AIR PIR integral occupancy sensor with automatic dimming photocell <sup>7,8</sup> RES7PDT nLight® AIR microphonics dual technology integral occupancy sensor with automatic dimming photocell <sup>7,8</sup> RIO nLight® AIR radio module without sensor <sup>7,8</sup> <b>Individual Control</b> MSD7ADCX PIR integral occupancy sensor with automatic dimming control photocell <sup>8</sup> MSPDPT7ADCX PDT integral occupancy sensor with automatic dimming control photocell <sup>8</sup>	EL7L 700 lumen battery pack (Noncompliant with CA T20) EL14L 1400 lumen battery pack (Noncompliant with CA T20) E10WLCP EM Self-Diagnostic battery pack, 10W Constant Power, Certified in CA Title 20 MAEDBS BGTD Bodine Generator Transfer Device <sup>10,11</sup> CP Chicago plenum <sup>12</sup> PWS1836 6' pre-wire 3/8" diameter, 18 gauge, 1 circuit PWS1846 6' pre-wire 3/8" diameter, 18 gauge, 2 circuit PWS1846 PWSLV Two cables: one 6' prewire, 3/8" diameter, 18 gauge, 2 circuits; one 6' pre-wire, 3/8" diameter, 18 gauge PWS1856LV 6' pre-wire, 3/8" diameter, 18 gauge, 1 circuit w/ low voltage wires BAA Buy America(n) Act Compliant

Accessories: Order as separate catalog number.	
2VT2 F916	Trim to adjust fixture mounting flush with 9/16" T-bar; for 2x2 fixture
DGA22 FS/VT	Drywall ceiling adapter with trim kit
2X2SMKSH PAF	Surface Mount Troffer Kit Post Paint

### Notes

- 1 Approximate lumen output.
- 2 Not available with SLD, EL7L and EL14L.
- 3 Not available with SLD, EL7L, EL14L or E10WLCP.
- 4 GZ1, GZ10 drivers not available with any Controls or sensor options.
- 5 Not available with N80, N80EMG, N100, or N100EMG, or NLTAIR2.
- 6 nLight EMG option requires a connection to existing nLight network. Power is provided from a separate N80 or N100 enabled fixture.
- 7 Must order with RES7, RES7PDT, or RIO module. Only available with EZ1/EZB driver.
- 8 Must specify ADPT diffuser. See sensor section on page 3.
- 9 Requires N80, N80EMG, N100, or N100EMG.
- 10 Not available with SLD or 72L
- 11 Must specify voltage. Requires BSE labeling, voltage specific. Consult factory for options.
- 12 Not available with N80, N80EMG, N100, N100EMG, PWS1836, PWS1846, PWS1846 PWSLV or PWS1856LV.

nLight® Wired Control Accessories: Order as separate catalog number. Visit <a href="http://www.acuitybrands.com/products/controls/nlight">www.acuitybrands.com/products/controls/nlight</a> .			
<b>WallPod stations</b>	<b>Model number</b>	<b>Occupancy sensors</b>	<b>Model number</b>
On/Off	nPDDM [color]	Small motion 360°, ceiling (PIR / dual tech)	nCM 9 RJB / nCM PDT 9 RJB
On/Off & raise/lower	nPDDM DX [color]	Large motion 360°, ceiling (PIR / dual tech)	nCM10 RJB / nCM PDT 10 RJB
Graphic touchscreen	nPOD GFX [color]	Wall switch with raise/lower	nWSX PDT LV DX [color]
<b>Photocell controls</b>	<b>Model number</b>	<b>Cat-5 cable (plenum rated)</b>	<b>Model number</b>
Full range dimming	nCM ADCX RJB	10' cable	CAT5 10FT J1
		30' cable	CAT5 30FT J1

nLight® AIR Control Accessories: Order as separate catalog number. Visit <a href="http://www.acuitybrands.com/products/controls/nlightair">www.acuitybrands.com/products/controls/nlightair</a> .	
<b>Wall switches</b>	<b>Model number</b>
On/Off single pole	rPODB [color] G2
On/Off two pole	rPODB 2P [color] G2
On/Off & raise/lower single pole	rPODB DX [color] G2
On/Off & raise/lower two pole	rPODB 2P DX [color] G2
On/Off & raise/lower single pole	rPODBZ DX WH G2

# 2VTL Volumetric Recessed Lighting 2'x2'

## ORDERING INFORMATION

rCMS							Example: RCMS PDT 10 AR G2		
Series/Detection		Occupancy Detection		Lens (Required)		Operating Mode		Generation	
RCMS	nLight AIR occupancy and daylight sensor	(blank)	PIR Detection	10	Large Motion/Extended Range 360°	(blank)	None	G2	Generation 2 compatibility
		PDT <sup>1</sup>	Dual Tech PIR/ Microphonics	9	Small Motion/Extended Range 360°	AIR	Auxiliary Relay		
				6	High Bay 360° Lens				

<sup>1</sup> RCMS requires low voltage power from either RPP20 DS 24V G2 or PS 150.



# 2VTL Volumetric Recessed Lighting 2'x2'

Sensor Options					
Option	Automatic Dimming Photocell	Occupancy Sensing		nLight Wired Networking	nLight AIR Networking
		PIR	PDT		
MSD7ADCX	X	X			
MSDPDT7ADCX	X		X		
NES7		X		X	
NES7ADCX	X	X		X	
NESPDT7			X	X	
NESPDT7ADCX	X		X	X	
RES7	X	X			X
RES7PDT	X	X	X		X

## Integrated Sensor with Individual Control

The MSD7ADCX PIR occupancy sensor/automatic dimming photocell is ideal for areas without obstructions and where daylight harvesting may be desired. Suggested applications include, but not limited to, hallways, corridors, storage rooms, and breakrooms or other areas where people are typically moving.

The MSDPDT7ADCX PIR/Microphonics Dual Tech occupancy sensor/automatic dimming photocell is ideal for areas with obstructions and where daylight harvesting is desired. Suggested applications include, but not limited to, open offices, private offices, classrooms, public restrooms, and conference rooms.

## Sequence of Operation

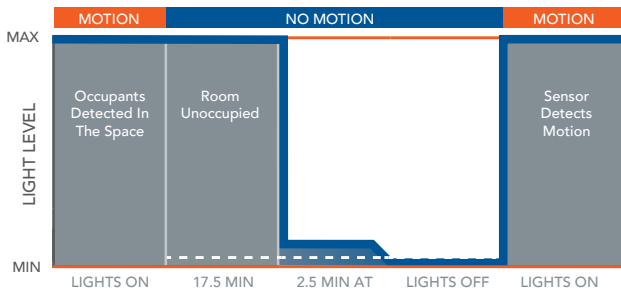

\*The presetting on the automatic dimming photocell is 5fc.

## Sensor Coverage Pattern Mini 360° Lens

- Recommended for walking motion detection from mounting heights between 8 ft (2.44 m) and 20 ft (6.10 m)
- Initial detection of walking motion along sensor axes at distances of 2x the mounting height up to 15 ft (4.57 m) and 1.75x up to 20 ft (6.10 m).
- Provides 12 ft (3.66 m) radial detection of small motion when mounted at 9 ft (2.74 m)
- Initial detection will occur earlier when walking across sensor's field of view than when walking directly at sensor

## 9 FT Mounting

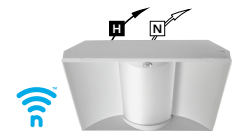
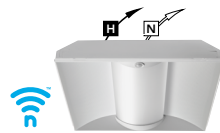
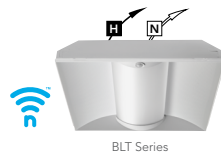
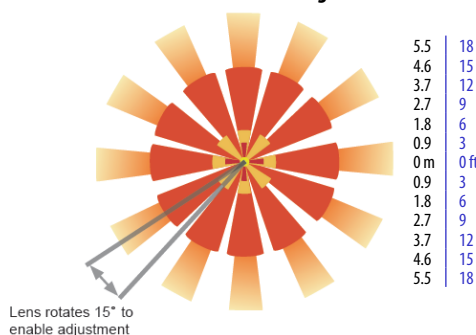

## Simple as 1,2,3

1. Install the nLight® AIR fixtures with embedded smart sensor
2. Install the wireless battery-powered wall switch
3. With our CLAIRITY app, pair the fixtures with the wall switch and if desired, customize the sensor settings for the intended outcome



## Basic nLight Zone



## nLight Wired Networking

The nES 7 is ideal for small rooms without obstructions or areas with primarily walking motion. Ideal areas include hallways, corridors, storage rooms, and breakrooms. Additionally, the NES7ADCX includes an integrated photocell, which enables daylight harvesting controls.

For areas like restrooms, private offices, open offices, conference rooms or any space with obstructions, the nES PDT 7 dual technology sensor is recommended. The nES PDT 7 utilizes both PIR (passive infrared) and Microphonics technologies to detect occupancy. Additionally, the NESPDT7ADCX includes an integrated photocell, which enables daylight harvesting controls which is ideal for areas where windows are present.

## nLight AIR Wireless

nLight AIR is the ideal solution for retrofit or new construction spaces where adding additional wiring can be labor intensive and costly. nLight AIR is available with or without an integral sensor. The integrated RES7 or RES7PDT smart sensors are part of each luminaire in the nLight AIR network, which can be grouped to control multiple luminaires. The granularity of control with the digital PIR occupancy detection and daylight sensing makes a great solution for any application.

## Sequence of Operation

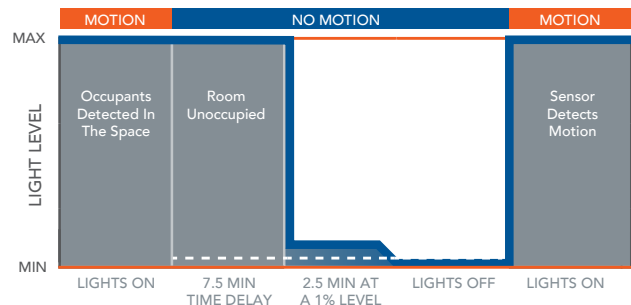

\*The presetting on the automatic dimming photocell is 5fc.

# 2VTL Volumetric Recessed Lighting 2'x2'

## PHOTOMETRICS

2VTL2 48L ADP LP835, 4761 delivered lumens.

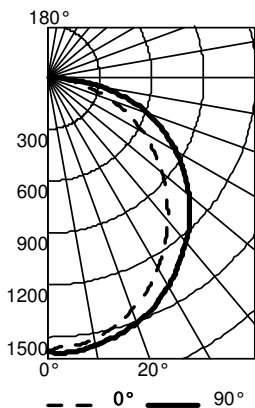

	0°	90°
0°	1582	1582
5°	1556	1589
15°	1489	1547
25°	1358	1458
35°	1175	1313
45°	974	1157
55°	750	960
65°	514	736
75°	271	474
85°	58	129
90°	2	0

### Coefficients of Utilization

pc	80%	20%		50%					
		70%	50%	30%	10%				
0	119	119	119	116	116	116	111	111	111
1	108	103	98	101	97	93	96	93	90
2	98	89	82	87	81	75	84	78	73
3	89	78	69	76	68	62	73	67	61
4	81	69	60	67	59	52	65	58	52
5	75	61	52	60	52	45	58	50	44
6	69	55	46	54	46	39	52	45	39
7	64	50	41	49	41	35	48	40	34
8	59	46	37	45	37	31	43	36	31
9	55	42	33	41	33	28	40	33	28
10	52	39	30	38	30	25	37	30	25

### Zonal Lumen Summary

Zone	Lumens	% Lamp	% Fixture
0° - 30°	1231	25.9	25.9
0° - 40°	2015	42.3	42.3
0° - 60°	3609	75.8	75.8
0° - 90°	4759	100.0	100.0
90° - 120°	1	0.0	0.0
90° - 130°	2	0.0	0.0
90° - 150°	2	0.0	0.0
90° - 180°	2	0.0	0.0
0° - 180°	4761	100.0	100.0

## Mounting Data

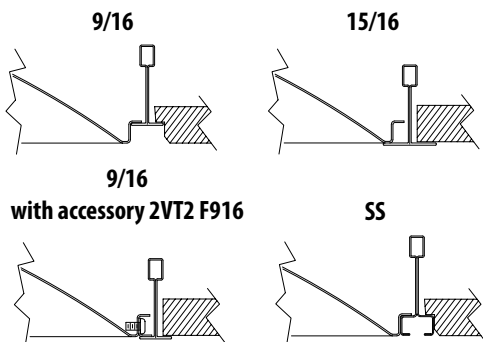

## Performance Data

Lumen Package	Lumens	Input Watts <sup>2</sup>	LPW
2VTL2 20L ADP LP830	2004	15.9	126
2VTL2 20L ADP LP835	2038	15.9	128
2VTL2 20L ADP LP840	2073	15.9	130
2VTL2 20L ADP LP850	2073	15.9	130
2VTL2 20L ADP LP930	1658	15.9	104
2VTL2 20L ADP LP935	1727	15.9	109
2VTL2 20L ADP LP940	1762	15.9	111
2VTL2 20L ADP LP950	1762	15.9	111
2VTL2 33L ADP LP830	3243	26.3	124
2VTL2 33L ADP LP835	3299	26.3	126
2VTL2 33L ADP LP840	3355	26.3	128
2VTL2 33L ADP LP850	3355	26.3	128
2VTL2 33L ADP LP930	2684	26.3	102
2VTL2 33L ADP LP935	2796	26.3	106
2VTL2 33L ADP LP940	2852	26.3	109
2VTL2 33L ADP LP950	2852	26.3	109
2VTL2 40L ADP LP830	4001	33.1	121
2VTL2 40L ADP LP835	4070	33.1	123
2VTL2 40L ADP LP840	4139	33.1	125
2VTL2 40L ADP LP850	4139	33.1	125
2VTL2 40L ADP LP930	3311	33.1	100
2VTL2 40L ADP LP935	3449	33.1	104
2VTL2 40L ADP LP940	3518	33.1	106
2VTL2 40L ADP LP950	3518	33.1	106
2VTL2 48L ADP LP830	4681	38.3	122
2VTL2 48L ADP LP835	4761	38.3	124
2VTL2 48L ADP LP840	4842	38.3	126
2VTL2 48L ADP LP850	4842	38.3	126
2VTL2 48L ADP LP930	3874	38.3	101
2VTL2 48L ADP LP935	4035	38.3	105
2VTL2 48L ADP LP940	4116	38.3	107
2VTL2 48L ADP LP950	4116	38.3	107
2VTL2 60L ADP LP830	5948	49.0	121
2VTL2 60L ADP LP835	6050	49.0	124
2VTL2 60L ADP LP840	6153	49.0	126
2VTL2 60L ADP LP850	6153	49.0	126
2VTL2 60L ADP LP930	4922	49.0	101
2VTL2 60L ADP LP935	5127	49.0	105
2VTL2 60L ADP LP940	5230	49.0	107
2VTL2 60L ADP LP950	5230	49.0	107
2VTL2 72L ADP LP830	7192	56.8	127
2VTL2 72L ADP LP835	7316	56.8	129
2VTL2 72L ADP LP840	7440	56.8	131
2VTL2 72L ADP LP850	7440	56.8	131
2VTL2 72L ADP LP930	5952	56.8	105
2VTL2 72L ADP LP935	6200	56.8	109
2VTL2 72L ADP LP940	6324	56.8	111
2VTL2 72L ADP LP950	6324	56.8	111

## How to Estimate Delivered Lumens in Emergency Mode

Use the formula below to estimate the delivered lumens in emergency mode

**Delivered Lumens = 1.25 x P x LPW**

P = Output power of emergency driver. P = 10W for E10WLCF option.

LPW = Lumen per watt rating of the luminaire. This information is available on the ABL luminaire spec sheet. LPW = Lumen per watt rating of the luminaire. LPW information available in Performance Data section.

Note: Based on ADP diffuser