

LED

HEADLIGHTS



Performance, Longevity, and Style

SYLVANIA LED Sealed Beam Headlights let you update your vehicle's lights with the clarity and performance of LED lighting technology.

Engineered to provide a superior 6000K white light, as well as style and durability, these direct replacement LED lamps are DOT compliant, legal for on-road use when installed properly. High-performance OSRAM OEM grade LED chips outlast traditional halogen lighting.

SYLVANIA LED Sealed Beam Headlights are backed by a 5-year limited warranty.²

6000K
COOL WHITE
LIGHT

DIRECT
INSTALL
REPLACEMENT

DOT
COMPLIANT

OEM
GRADE
LED CHIPS

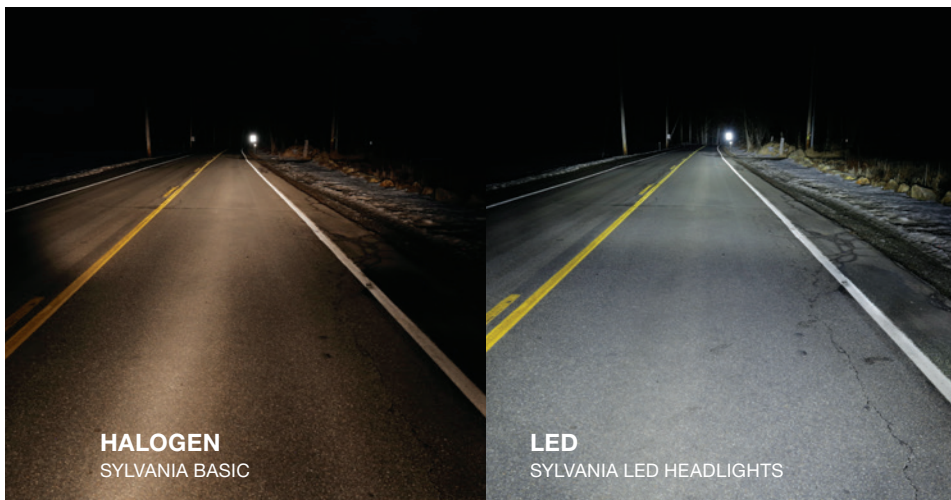

HALOGEN
SYLVANIA BASIC

LED
SYLVANIA LED HEADLIGHTS

Experience the difference
of LED lights

SYLVANIA

#1 AFTERMARKET AUTOMOTIVE LIGHTING BRAND IN THE USA¹

Upgrade your sealed beam headlights to LED

FEATURES & BENEFITS:

- 5 YEAR LIMITED WARRANTY²
- Designed for performance, longevity, and style.
- Superior 6000K cool-white light for better clarity.³
- Direct install replacement. Easy to install.
- Water resistant: IP67 rated
- DOT Compliant: meets DOT regulations and SAE standards. Legal for on-road use and does not create dangerous glare when installed properly.
- OEM grade, high-performance OSRAM LED chips outlast traditional halogen lighting.



STOCKING CODE: H6024SL.BX

ALSO FITS: H6014/H6015

PACK SIZE: 1 lamp / box

PACKAGE DIMENSIONS:
7.12" L x 4.61" W x 7.12" H



STOCKING CODE: H6054SL.BX

ALSO FITS: H6052

PACK SIZE: 1 lamp / box

PACKAGE DIMENSIONS:
8.00" L x 4.62" W x 5.79" H

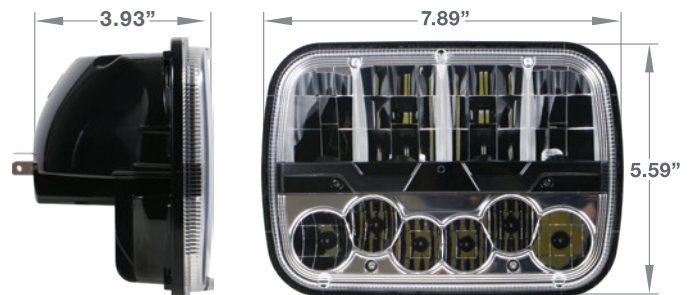
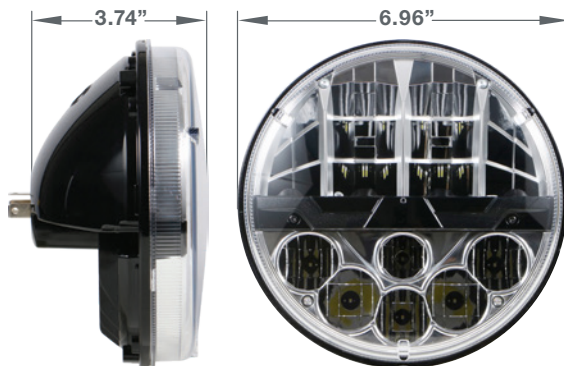



STOCKING CODE: H4651SL.BX

PACK SIZE: 1 lamp / box

PACKAGE DIMENSIONS:
7.00" L x 4.56" W x 4.50" H

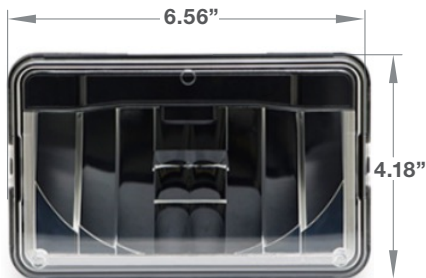

STOCKING CODE: H4656SL.BX

PACK SIZE: 1 lamp / box

PACKAGE DIMENSIONS:
7.00" L x 4.56" W x 4.50" H

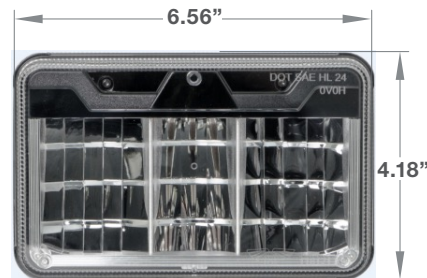

SSS
HEATED

NEW! Heated LED sealed beam headlights

FEATURES & BENEFITS:

- **5 YEAR LIMITED WARRANTY²**
- **Heated to melt snow and ice**
- Designed for performance, longevity, and style.
- Superior 6000K cool-white light for better clarity.³
- Direct install replacement. Easy to install.
- Water resistant: IP67 rated
- DOT Compliant: meets DOT regulations and SAE standards. Legal for on-road use and does not create dangerous glare when installed properly.
- OEM grade, high-performance OSRAM LED chips outlast traditional halogen lighting.



STOCKING CODE: H6024SLHT.BX

ALSO FITS: H6014/H6015

PACK SIZE: 1 lamp / box

PACKAGE DIMENSIONS:

7.12" L x 4.61" W x 7.12" H



STOCKING CODE: H6054SLHT.BX

ALSO FITS: H6052

PACK SIZE: 1 lamp / box

PACKAGE DIMENSIONS:

8.00" L x 4.62" W x 5.79" H

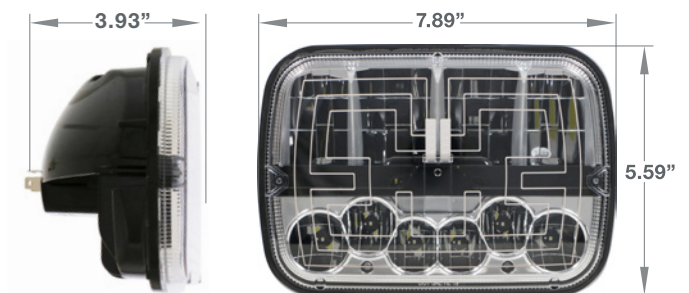
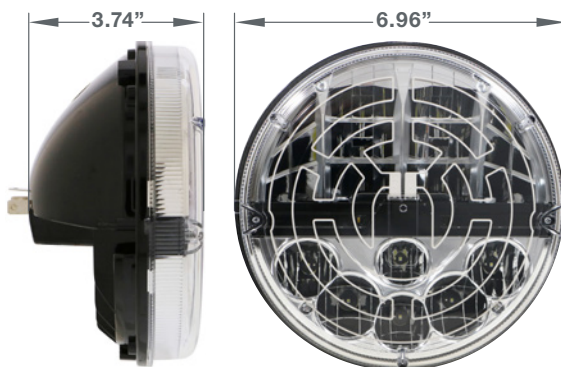

OSRAM SYLVANIA Inc.

275 West Main St., Hillsboro, NH 03244

1-800-729-3777 | sylvania-automotive.com

SYLVANIA is a registered trademark of OSRAM SYLVANIA Inc.

¹Source: Circana/U.S. Retail Tracking Service, March 2, 2024

²See package for details

³Compared to SYLVANIA Basic

SYLVANIA

#1 AFTERMARKET AUTOMOTIVE LIGHTING BRAND IN THE USA¹