

The Power of Illumination

www.bplusl.com

Electronic transformer



GENERAL SPECIFICATIONS :

- Input 120 Volts 50/60 Hz
- Power factor > .93
- THD < 20%
- Operating frequency > 10 kHz
- Class A insulation system, maximum transformer temperature for 90°C
- Minimum load of 10 Watts. Consult factory for LEDs
- Generally the dimmer should have a minimum load of 40 W for proper functioning. Consult with UL recommendations for temperatures higher than 90°C
- For non short proof units, do not short output conductors
- Dimmable for halogen lamps only

GENERAL LAMP CHARACTERISTICS :

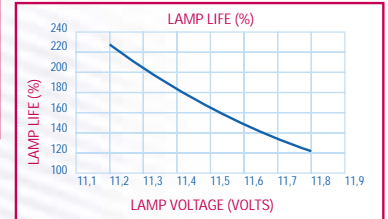
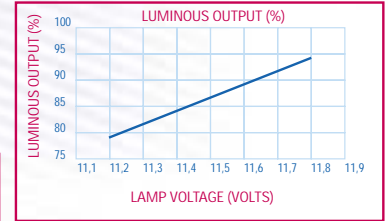
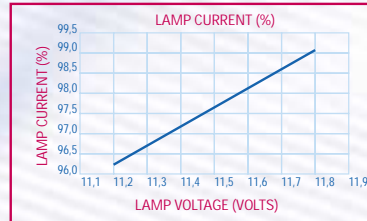

PLASTIC CASING

Electronic circuitry is encapsulated in a flame retardant plastic casing to withstand harsh and damp conditions for temperatures ranging from +5°F to +195°F (-15°C to 90°C)

Input : 120 VAC - for 12 Volts lamps

MODEL NO.	MAXIMUM LOAD	CLASS 2	OVERLOAD PROTECTION	SHORT CIRCUIT PROTECTION	RFI	CASING
CV90001	75 WATTS					D
CV90010	105 WATTS					B
CV90012	150 WATTS					B
CV90020	75 WATTS				YES	D
CV90021	200 WATTS					B
CV90027*,**	60 WATTS	YES	YES	YES	YES	C
CV90049	60 WATTS	YES	YES	YES	YES	A

SEE REQUIRED MOUNTING INSTRUCTIONS FOR CONVERTER MODEL CV90021 (ALSO RECOMMENDED FOR MODEL CV90012)

Input : 120 VAC - for 24 Volts lamps

MODEL NO.	MAXIMUM LOAD	CLASS 2	OVERLOAD PROTECTION	SHORT CIRCUIT PROTECTION	RFI	CASING
CV90038	75 WATTS					D
CV90052	150 WATTS					B

Input : 230 VAC - for 12 Volts lamps

MODEL NO.	MAXIMUM LOAD	CLASS 2	OVERLOAD PROTECTION	SHORT CIRCUIT PROTECTION	RFI	CASING
CV90036*	75 WATTS					D
CV90113*	150 WATTS					B

Input : 277 VAC - for 12 Volts lamps

MODEL NO.	MAXIMUM LOAD	CLASS 2	OVERLOAD PROTECTION	SHORT CIRCUIT PROTECTION	RFI	CASING
CV90111*	150 WATTS					B
CV90112*	75 WATTS					D

* Not dimmable

** Not suitable for damp location

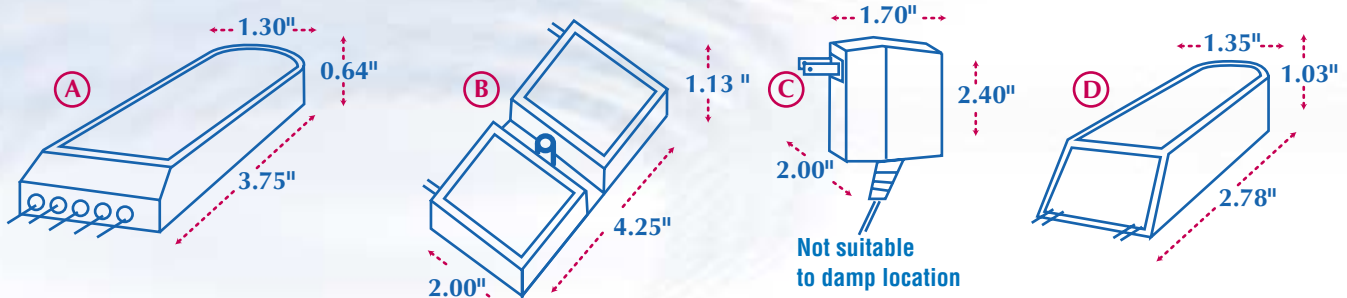

METAL CASING

Electronic circuitry housed in a galvanized perforated steel enclosure

60 WATTS

Input : 120 VAC - for 12 Volts lamps

MODEL NO.	CLASS 2	RFI	OVERLOAD PROTECTION	SHORT CIRCUIT PROTECTION
CV90095				
CV90096		YES		
CV90097	YES		YES	YES
CV90098	YES	YES	YES	YES

75 WATTS

Input : 120 VAC - for 12 Volts lamps

MODEL NO.	CLASS 2	RFI	OVERLOAD PROTECTION	SHORT CIRCUIT PROTECTION
CV90080				
CV90081		YES		
CV90082			YES	YES
CV90083		YES	YES	YES

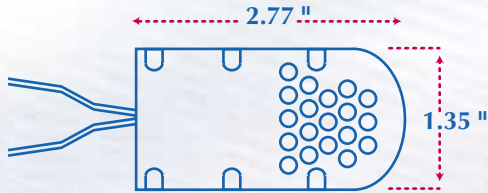

150 WATTS

Input : 120 VAC - for 12 Volts lamps

MODEL NO.	CLASS 2	RFI	OVERLOAD PROTECTION	SHORT CIRCUIT PROTECTION	DC OUTPUT
CV90105					
CV90106		YES			
CV90107			YES	YES	
CV90108		YES	YES	YES	
CV90109		YES	YES	YES	YES

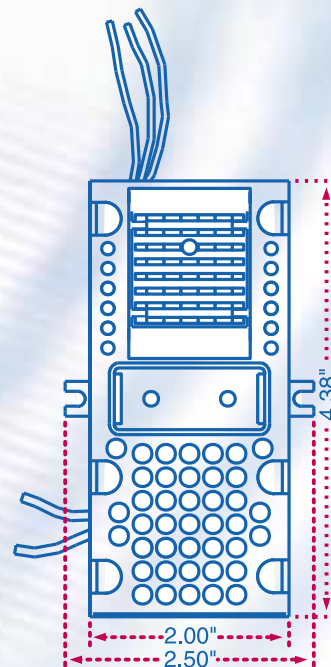
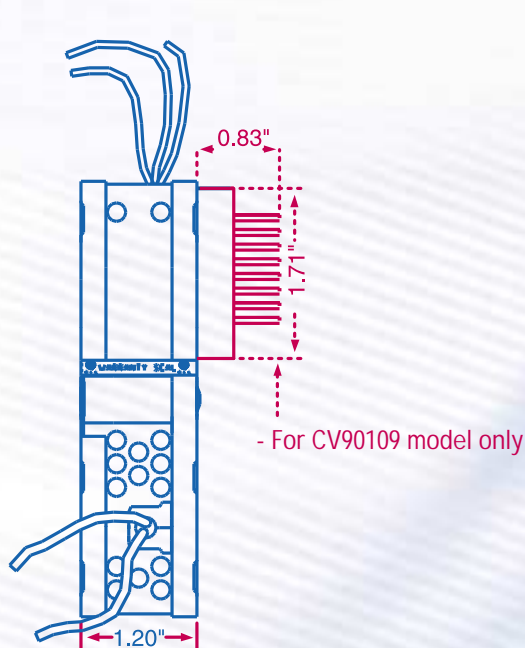

OPEN FRAME

60 WATTS

Input : 120 VAC - for 12 Volts lamps

MODEL NO.	CLASS 2	RFI	OVERLOAD PROTECTION	SHORT CIRCUIT PROTECTION	HEAT SINK
CV90090					
CV90091		YES			
CV90092	YES		YES	YES	
CV90093	YES	YES	YES	YES	
CV90094					YES

75 WATTS

Input : 120 VAC - for 12 Volts lamps

MODEL NO.	CLASS 2	RFI	OVERLOAD PROTECTION	SHORT CIRCUIT PROTECTION	HEAT SINK
CV90074					
CV90075		YES			
CV90076			YES	YES	
CV90077		YES	YES	YES	
CV90079					YES

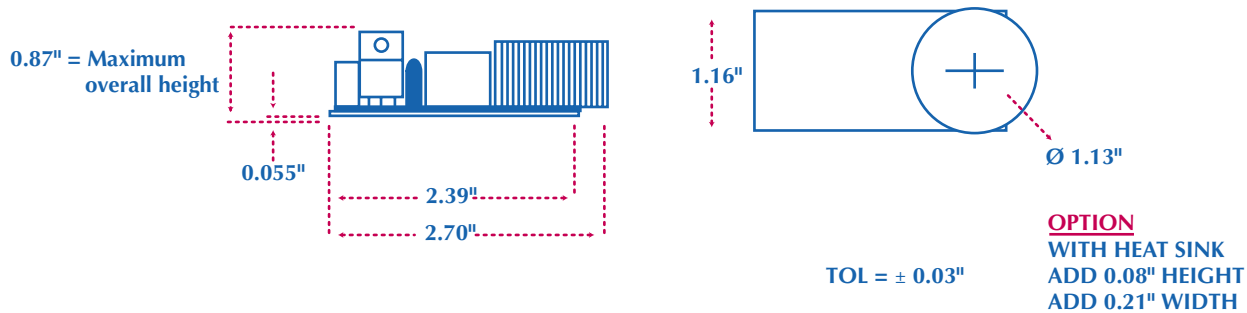

CABLING DIAGRAM

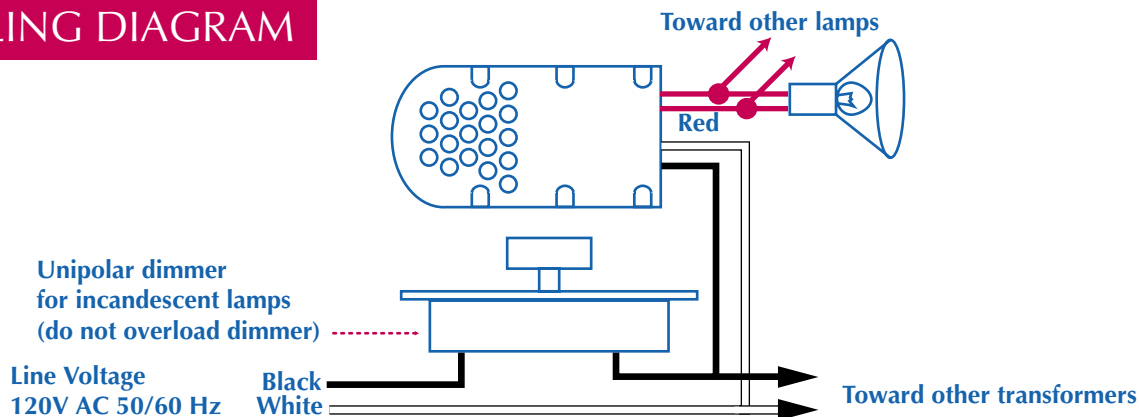

For non short proof units, do not short output conductors

WARRANTY

2 years from delivery date for :
Electronic transformer

3570 Charter Park Drive
San Jose, CA 95136
USA
Tel.: (408) 269-7884
1-800-361-1400
Fax: (408) 269-7638
www.bplusl.com
sales@bplusl.com

