



# CorePro LED PLC 2P

## CorePro LED PLC 8.5W 830 2P G24d-3

The CorePro LED PLC 2P integrates a LED light source into a traditional fluorescent form factor. This product is the ideal solution for uplamping in general lighting applications: it meets basic lighting requirements, offers significant energy savings and is environmentally friendly.

### Product data

General information	
Cap base	G24D-3 [ G24d-3]
CE mark	Yes
EU RoHS compliant	Yes
Nominal lifetime (nom.)	30000 h
Switching cycle	50000
	Sphere
Tier	CorePro

Light technical	
Colour Code	830 [ CCT of 3,000 K]
Beam Angle (Nom)	120 °
Luminous flux (nom.)	950 lm
Colour designation	White (WH)
Correlated Colour Temperature (Nom)	3000 K
Luminous efficacy (rated) (nom.)	105.88 lm/W
Colour consistency	<6
Colour rendering index (nom.)	83
LLMF at end of nominal lifetime (nom.)	70 %

Operating and electrical	
Input frequency	50 to 60 Hz
Power (Rated) (Nom)	8.5 W

Lamp current (max.)	43 mA
Lamp current (min.)	33 mA
Starting time (nom.)	0.5 s
Warm-up time to 60% light (nom.)	0.5 s
Power factor (nom.)	0.9
Voltage (Nom)	220-240 V

Temperature	
T-ambient (max.)	35 °C
T-ambient (min.)	-20 °C
T-storage (range)	-40°C to 65°C
T storage (max.)	65 °C
T storage (min.)	-40 °C
T-Case maximum (nom.)	75 °C

Controls and dimming	
Dimmable	No

Mechanical and housing	
Bulb material	Plastic
Product length	200 mm
Bulb shape	Tube, single-ended

# CorePro LED PLC 2P

## Approval and application

Energy Efficiency Class	F
Energy-saving product	Yes
Approval marks	TUV CE marking RoHS compliance KEMA Keur certificate
Energy consumption kWh/1,000 hours	9 kWh 403554

## Product data

Full product code	871869654123400
-------------------	-----------------

Order product name	CorePro LED PLC 8.5W 830 2P G24d-3
EAN/UPC – product	8718696541234
Order code	54123400
SAP numerator – quantity per pack	1
Local code description	CorePro LED PLC 8.5W 830 2P G24d-3
Numerator – packs per outer box	10
SAP material	929001201202
Net Weight (Piece)	0.090 kg

## Dimensional drawing

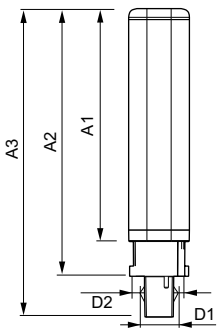

CorePro LED PLC 8.5W 830 2P G24d-3

Product	D1	D2	A1	A2	A3
CorePro LED PLC 8.5W 830 2P G24d-3	24.3 mm	28.4 mm	128.8 mm	148 mm	170.6 mm

## Photometric data

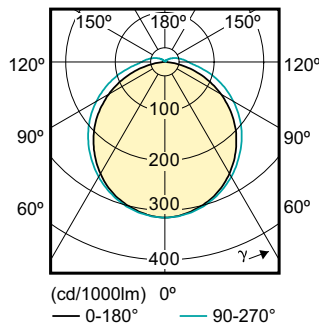
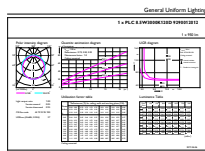

LEDtube PLC 100mm 9W G24D-3 830 950lm

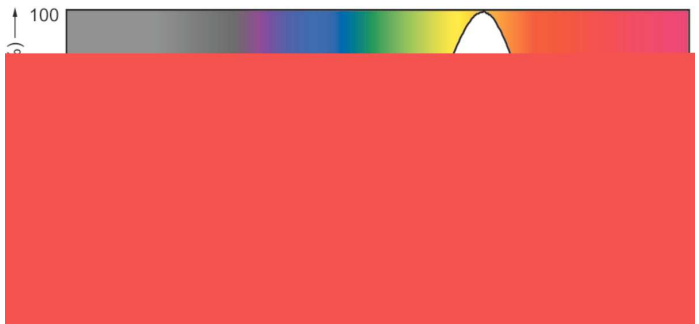

# CorePro LED PLC 2P

## Lifetime

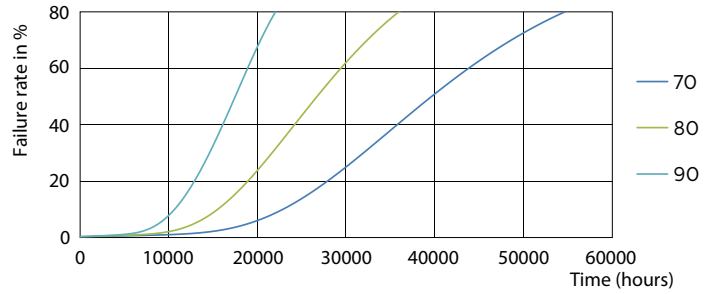
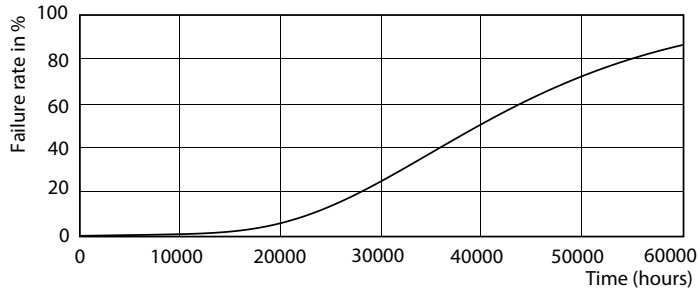

LEDtube PLC 100mm 9W G24D-3 830 950lm

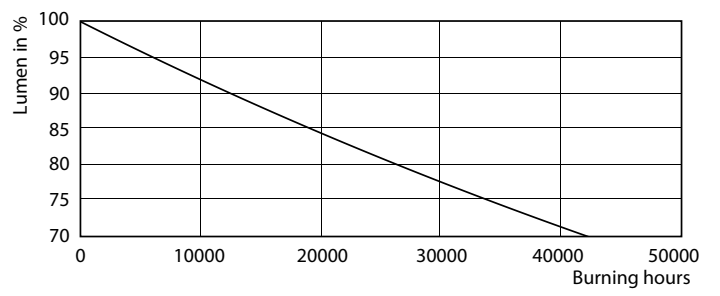

LEDtube PLC 100mm 9W G24D-3 830 950lm

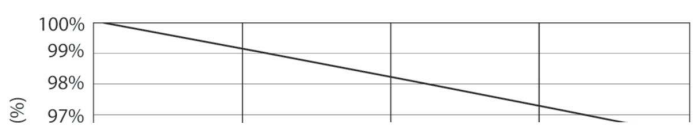

LEDtube PLC 100mm 9W G24D-3 830 950lm

LEDtube PLC 100mm 9W G24D-3 830 950lm

## CorePro LED PLC 2P

