



CorePro LED PLC 2P



CorePro LED PLC 6.5W 840 2P G24d-2

CorePro LED PLC 2P integrates a LED light source into a traditional fluorescent form factor. This product is the ideal solution for uplamping in general lighting applications: it meets basic lighting requirements, offers significant energy savings, and is environmentally friendly.

Product data

General Information	
Cap-Base	G24d-2
Nominal lifetime	30,000 hour(s)
Switching Cycle	50,000
Lighting Technology	LED
Flux measurement reference	Sphere
CE mark	Yes
EU RoHS compliant	Yes

Light Technical	
Color Code	840 [CCT of 4000K]
Beam Angle (Nom)	120 degree(s)
Luminous Flux	700 lm
Color Designation	Cool White (CW)
Correlated Color Temperature (Nom)	4000 K
Luminous Efficacy (rated) (Nom)	92.31 lm/W
Color Consistency	<6
Color rendering index (CRI)	83
LLMF At End Of Nominal Lifetime (Nom)	70 %
Photobiological safety according to EN 62471	RGO

Operating and Electrical	
Line Frequency	50 to 60 Hz

Input Frequency	50 to 60 Hz
Power Consumption	6.5 W
Lamp Current (Max)	35 mA
Lamp Current (Min)	25 mA
Starting Time (Nom)	0.5 s
Warm-up time to 60% light	0.5 s
Power Factor (Fraction)	0.9
Voltage (Nom)	220-240 V
LED alternative to fluorescent lamp power	18 W
Inrush current at mains	3.4
Max. lamp no. on MCB B type 10A - Mains	123
Max. lamp no. on MCB B type 10A – EM ballast without Comp. Cap.	150
Max. lamp no. on MCB B type 10A – EM ballast with Comp. Cap.	30
Max. lamp no. on MCB B type 16A - Mains	197
Max. lamp no. on MCB B type 16A – EM ballast without Comp. Cap.	220
Max. lamp no. on MCB B type 16A – EM ballast with Comp. Cap.	49

Temperature	
Ambient temperature range	-20 °C to 35 °C

CorePro LED PLC 2P

T-Case Maximum (Nom)	65 °C
Controls and Dimming	
Dimmable	No
Mechanical and Housing	
Bulb Material	Plastic
Product Length	100 mm
Bulb Shape	PL-C
Approval and Application	
Energy Efficiency Class	F
Energy Saving Product	Yes
Approval Marks	TUV CE marking RoHS compliance KEMA Keur certificate
Energy Consumption kWh/1000 h	7 kWh

EPREL Registration Number	403557
Product Data	
Order product name	CorePro LED PLC 6.5W 840 2P G24d-2
Full product name	CorePro LED PLC 6.5W 840 2P G24d-2
Full product code	871869654129600
Order code	929001201502
Material Nr. (12NC)	929001201502
Numerator - Quantity Per Pack	1
EAN/UPC - Product/Case	8718696541296
Numerator - Packs per outer box	10
EAN/UPC - Case	8718696541302

Dimensional drawing

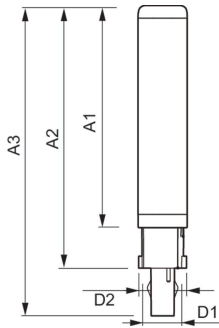

Product	D1	D2	A1	A2	A3
CorePro LED PLC 6.5W 840 2P G24d-2	24.3 mm	28.4 mm	105.8 mm	125 mm	147.6 mm

Photometric data

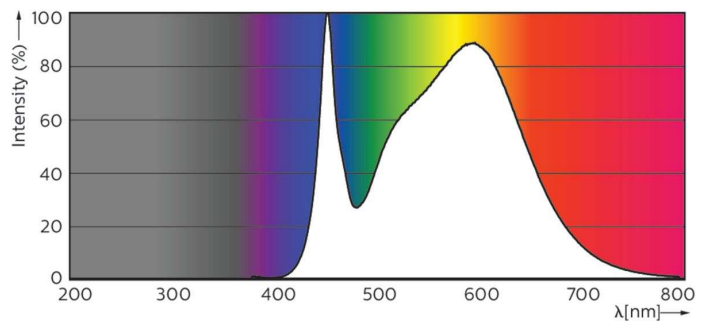
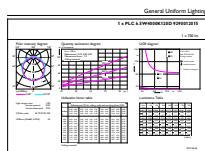

General uniform lighting - CorePro LED PLC 6.5W 840 2P G24d-2

Spectral Power Distribution Colour - CorePro LED PLC 6.5W 840 2P G24d-2

CorePro LED PLC 2P

Photometric data

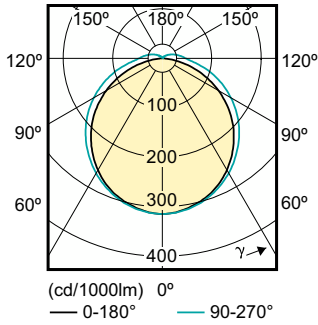

Light Distribution Diagram - CorePro LED PLC 6.5W 840 2P G24d-2

Lifetime

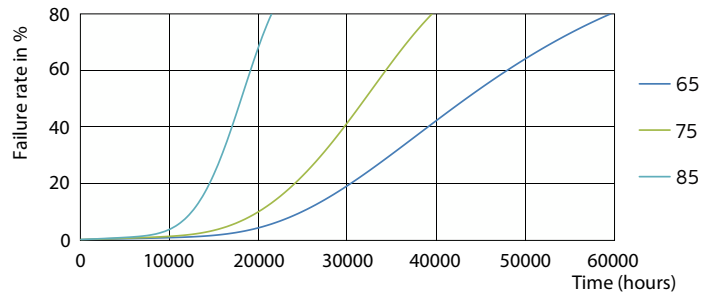
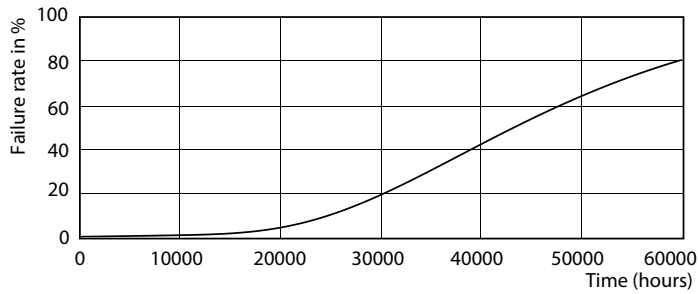

Life Expectancy Diagram - CorePro LED PLC 6.5W 840 2P G24d-2

Life Expectancy Diagram - CorePro LED PLC 6.5W 840 2P G24d-2

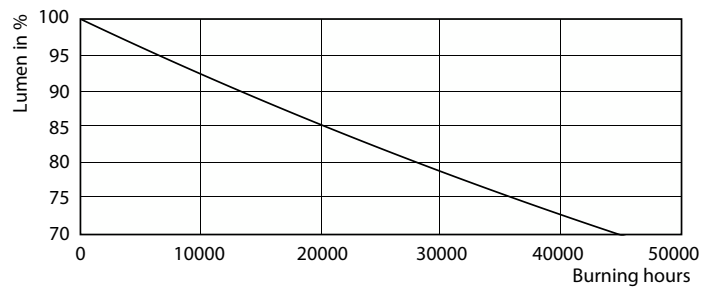
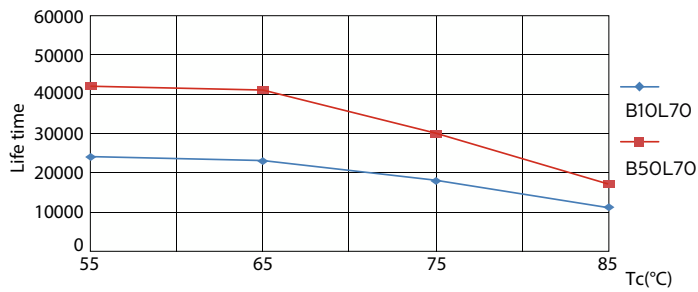

Life Expectancy Diagram - CorePro LED PLC 6.5W 840 2P G24d-2

Lumen Maintenance Diagram - CorePro LED PLC 6.5W 840 2P G24d-2

CorePro LED PLC 2P

Lifetime

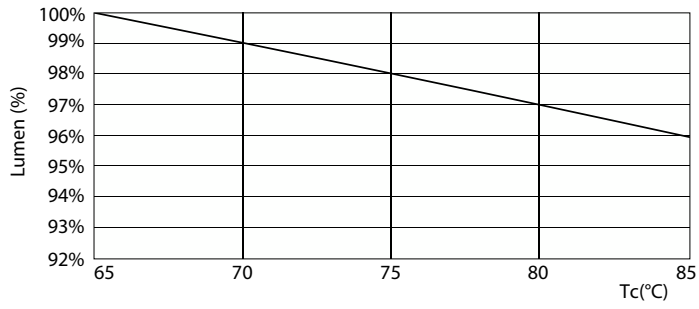

Lumen Maintenance Diagram - CorePro LED PLC 6.5W 840 2P G24d-2

