

Project		Catalog #		Type	
Prepared by		Notes		Date	



# iO LED

## CovSelect

LED  
Interior Architectural Cove  
Integral Driver

### Typical Applications

Commercial Office Spaces • Schools • Hospitals  
Retail • Residential • Hospitality • Restaurants

### Interactive Menu

- Composing an Order page 2
- Catalog Number Details page 3
- Product Specifications page 4
- Photometric Data page 5
- Mounting and Installation page 7
- Run Layout Guidelines page 8

### Product Certification



### Product Features



### Top Product Features

- Cove lighting fixture with integral dimming driver
- Rated for interior / damp installations
- 5 Field Selectable CCTs (2400K, 2700K, 3000K, 3500K, 4000K)
- 90 CRI Standard with 3 SDCM binning
- Field Selectable output nominal (350 lm/ft and 700 lm/ft) with lockout plate
- Up to 200ft run from a single power drop
- 1 ft and 4 ft length options
- Corner (COR) fixture available for continuous illumination of corners and curves
- Adjustable mount (+/- 30 deg)
- Integral 0-10V dimming (100%-10%)
- DALI and WaveLinx control options available

### Dimensions

NOTE: Additional dimensions provided on page 9

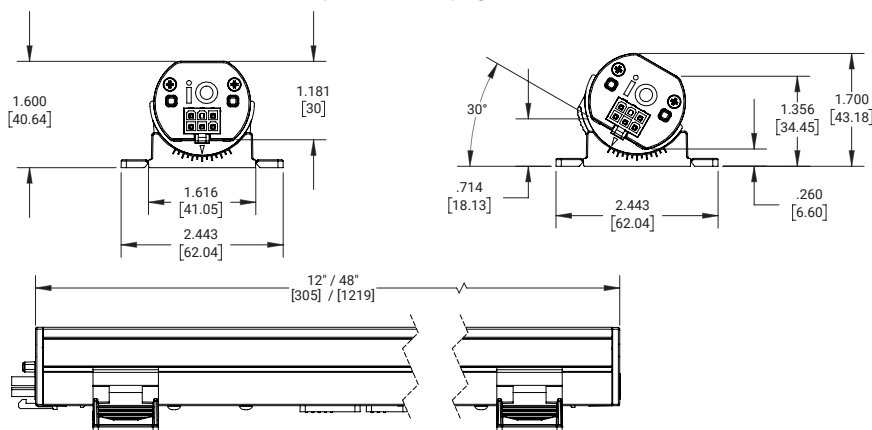

### Scale

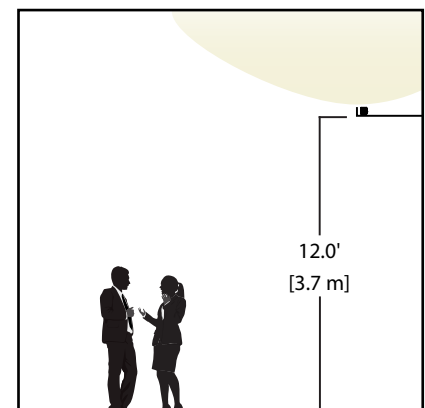

additional product diagrams

## Composing an Order

Orders must include:

1 Fixture(s) + 2 Power Harness / Control Module + 3 Optional Accessories as needed

### 1 Fixtures (REQUIRED)

Catalog Number	Length	CCT Setting	Low Output Setting (3.5W)		High Output Setting (7W)	
			Lumens (lm)	Efficacy (LPW)	Lumens (lm)	Efficacy (LPW)
CS-SL-9SCT-120-ID-UNV-W-SA-STD-1F CS-SL-9SCT-120-ID-UNV-W-SA-STD-COR	1 ft (12" / 305 mm)	2400K	339	97	731	104
		2700K	351	100	759	108
		3000K	359	103	778	111
		3500K	369	105	801	114
		4000K	379	108	827	118
CS-SL-9SCT-120-ID-UNV-W-SA-STD-4F	4 ft (48" / 1220 mm)	2400K	1661	119	3336	119
		2700K	1719	123	3454	123
		3000K	1758	126	3532	126
		3500K	1805	129	3626	129
		4000K	1854	132	3725	133

### 2 Power Harness/Control Modules (REQUIRED)

Note: Please utilize adjacent iO CovSelect Run Length Limits<sup>1</sup> chart to determine the number of power harnesses / control modules required to support planned runs.

Catalog Number	Details
CS-10V-STD-72CORD	72" Cord and plug accessory (can be used in lieu of CS-10V-STD)
CS-10V-STD	Standard power harness (for beginning of run power connection)
CS-10V-BOX	Power connection box without harness for small spaces.
<b>Notes</b>	
1. A power harness, power connection box or control module is required for line voltage connection of each run.	
2. DALI and WaveLinX control modules can be added to CS-10V-BOX only. DALI and WaveLinX control modules must be ordered separately as accessories (see section 3 below).	

### 3 Accessories (OPTIONAL)

Catalog Number	Details
CS-10V-STD-72CORD	72" Cord and plug accessory
CS-JHARN02-006	6" Jumper accessory
CS-JHARN02-012	12" Jumper accessory
CS-HARN02-060	60" Jumper accessory
CS-JHARN02-144	144" Jumper accessory
CS-DLENS-1F	Diffuse lens accessory, 1 ft
CS-DLENS-4F	Diffuse lens accessory, 4 ft
DAC-DC1	DALI control module (can be added to CS-10V-BOX for DALI control)
RSP-P-010-347	WaveLinX control module (can be added to CS-10V-BOX for WaveLinX wireless control)
CS-10V-STD	Standard Power Harness (for beginning of run power connection)
CS-10V-BOX	Power connection box without harness for small spaces
<b>Notes</b>	
1. A power harness, power connection box or control module is required for line voltage connection of each run.	
2. DALI and WaveLinX control modules can be added to CS-10V-BOX only. DALI and WaveLinX control modules must be ordered separately as accessories (see section 3 below).	

## iO CovSelect Run Length Limits<sup>1</sup>

		Run Length Limits (ft)	
		Fixture Length	1F = 12" / 4F = 48"
		Fixture Input Wattage	6.2 W / 20.6 W
		Source Current	0.2mA / 0.2mA
		Input Current (120-277V)	64.8mA / 222mA
Dimming Protocol	0-10V (STD)	Maximum Run Length (ft) @ 120V	100 / 116*
		Maximum Run Length (ft) @ 277V	150*** / 288**
<b>Notes</b>			
*Run must be limited to 100 ft when using both 1F and 4F fixtures in a single run at 120V.			
**Run must be limited to 200 ft when using both 1F and 4F fixtures in a single run at 277V.			
*** Run length is limited based on common 30 mA dimmer limit. Run length could be extended to 200 ft for dimmers with 50 mA current rating.			

### Catalog Number Details

No QS prefix needed for Stock or Quick Ship orders.

SAMPLE CATALOG NUMBER: **CS-SL-9SCT-120-ID-UNV-W-SA-STD-4F**

Series	Lumen Package (Power)	LED CRI & CCT	Optical Distribution	Environment	Voltage
<b>CS</b> =CovSelect Linear LED	<b>SL</b> =Selectable Output (350lm/ft or 700lm/ft)	<b>9SCT</b> = 90+ CRI, Selectable CCT	<b>120</b> =Standard Lambertian	<b>ID</b> =Indoor	<b>UNV</b> =120-277V
<b>Notes</b> Architectural LED cove luminaire with integral driver from iO LED.	<b>Notes</b> Nominal for 12" section. See Lumen Multiplier Chart below for absolute lumen output per wattage and CCT setting.	<b>Notes</b> 5 selectable CCT settings: 2400K   2700K   3000K   3500K   4000K.	<b>Notes</b> CovSelect is indoor rated for damp locations only.	<b>Notes</b> CovSelect is indoor rated for damp locations only.	<b>Notes</b> See iO CovSelect Run Length Limits for limitations.

Housing Color	Mounting	Control	Length
<b>W</b> =Standard White	<b>SA</b> =Surface Mount - Adjustable	<b>STD</b> =0-10V dimming (100%-10%)	<b>1F</b> =1 ft (12") Individual fixture <b>4F</b> =4 ft (48") Individual fixture <b>COR</b> = Corner and curved installations (for use without jumper cable)
<b>Notes</b>	<b>Notes</b> Mounting bracket has built in +/- 30 deg adjustability and can be mounted in any orientation including direct, indirect, or wall mounted. Mounting brackets are shipped integral to fixture for easy installation.	<b>Notes</b> Integral 0-10V dimming driver standard.	<b>Notes</b>

### Accessories

(OPTIONAL)

Note: Jumpers are required for all curves and corners in planned runs if not using the corner fixture (COR).

Catalog Number	Details
<b>CS-10V-STD-72CORD</b>	72" Cord and plug accessory
<b>CS-JHARN02-006</b>	6" Jumper accessory
<b>CS-JHARN02-012</b>	12" Jumper accessory
<b>CS-HARN02-060</b>	60" Jumper accessory
<b>CS-JHARN02-144</b>	144" Jumper accessory
<b>CS-DLENS-1F</b>	Diffuse lens accessory, 1 ft
<b>CS-DLENS-4F</b>	Diffuse lens accessory, 4 ft
<b>DAC-DC1</b>	DALI control module (can be added to CS-10V-BOX for DALI control)
<b>RSP-P-010-347</b>	WaveLinx control module (can be added to CS-10V-BOX for WaveLinx wireless control)
<b>CS-10V-STD</b>	Standard Power Harness (for beginning of run power connection)
<b>CS-10V-BOX</b>	Power connection box without harness for small spaces
<b>Notes</b>	
1. A power harness, power connection box or or control module is required for line voltage connection of each run.	
2. DALI and WaveLinx control modules can be added to CS-10V-BOX only. DALI and WaveLinx control modules must be ordered separately as accessories (see section 3 below).	

## Product Specifications

### Construction

- Extruded aluminum, powder coated housing.
- Diffuse polycarbonate extruded lens.
- Proprietary quick connect plugs for fast installation.
- Available in 1 ft (12") or 4 ft (48") lengths.
- COR option available with extended connection cable for maximum fixture placement flexibility in installing corners or curves with continuous light distribution.

### Electrical

- Integral high performance constant current driver.
- Field Selectable output with nominal 350 lm/ft and 700 lm/ft setting options.
- Lockout plate included to assure desired power ratings during and after inspections.
- Flicker free performance with PST < 1.0 and SVM < 1.0.
- Standard 0-10V dimming (10% - 100%).
- Each cove module is configured for a line voltage feed while providing through wiring and quick connects for continuous mounting applications.
- Universal driver accepts 120V to 277V supply voltage. 277V supply voltage increases run lengths possible from a power drop.
- Utilize jumpers and separate power feed(s) to create emergency circuits. Consult customer service for additional assistance.
- See page 2 for iO CovSelect Run Length Limits for limitations.
- See pg 7 for Dimmer Compatibility chart.

### LED Optics

- 90+ CRI standard with 3 SDCM binning.
- Field Selectable CCT with 2400K, 2700K, 3000K, 3500K or 4000K setting options maintain 3-step MacAdam Ellipse across selectable CCT range.
- Discrete mid-powered LED array with diffuse, extruded lens delivers a cove light distribution free from striations.
- Field-installable diffuse lens accessory is optional for added diffusion.
- Fixtures designed to connect directly via plug-and-play connectors to deliver the most consistent cove illumination possible.
- Luminaires tested per IESNA LM-79.
- TM-21 lifetime extrapolation based on LM-80 data:  
L70 at 25°C > 60,000 hours  
L90 at 25°C = 52,000 hours

### Mounting

- Each individual fixture comes standard with molded polycarbonate mounting bracket(s) with integrated +/- 30 deg adjustability.
- Can be mounted in any orientation including direct, indirect, or wall mounted. Mounting brackets are shipped integral to fixture for easy installation.
- Mounting has scoring line on one side for tightly spaced installations. Note 2 mounts per fixture and at least 1 screw per mount is required for secure installation.
- Power harness is required for connection to line voltage at the beginning of each run and must be ordered separately as an accessory.
- STD power harness includes beginning of run power harness and junction box for line voltage connection.
- Power connection box (CS-10V-BOX) is available without power harness for when minimal installation space is desired.
- Fixture end caps include quick connects for easy and secure end-to-end installation in straight runs. Release tab must be pressed to disconnect fixtures.
- Corner (COR) option available with extended connection cable for fixture placement flexibility in installing corners or curves with Corner (COR) continuous light distribution.
- Jumper cables are available in a variety of lengths (6", 12", and 144") to enable a wide variety of curved installations and avoid interference with other building and architectural systems. Jumpers must be ordered separately as accessories.

### Finish

- Powder-coated aluminum housing.
- Standard color is white with white end caps and white power harness and white jumpers.

### Compliance

- Luminaires are ULus listed for 50° C ambient environments.
- Title 24 / JA8 certified.
- Damp Location Listed.
- RoHS compliant.
- Tested according to IESNA LM-79 (See pg pg 5). Full set of IES files are available at CooperLighting.com.

### Environment

- Suited for indoor / damp installations.

### Control

- Integral 0-10V driver standard with minimum dim level of 10%.
- DALI and WaveLinx control is possible for run by adding appropriate control module accessory to CS-10V-BOX.

### Weight

- 1F = 0.46 lbs
- 4F = 1.33 lbs

### Warranty

- 5-year standard limited warranty.

Photometric Data

 View IES files

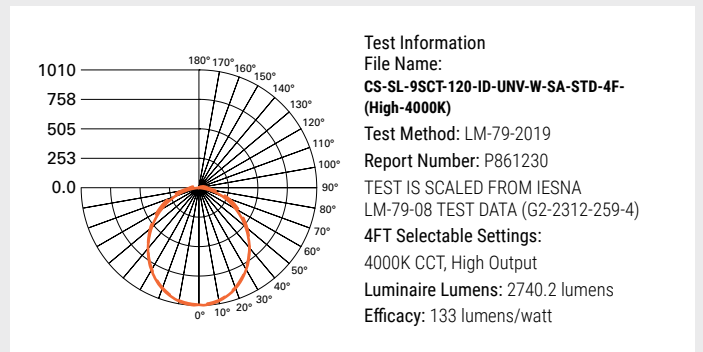
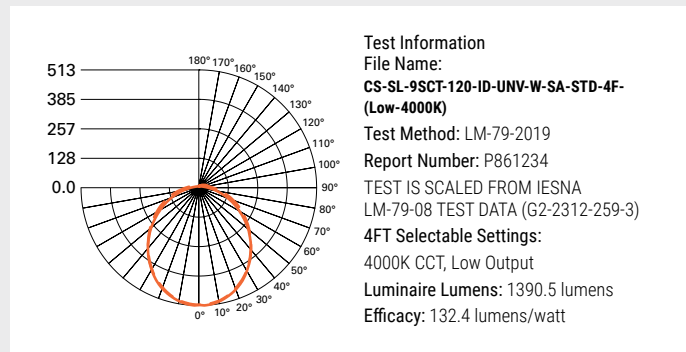
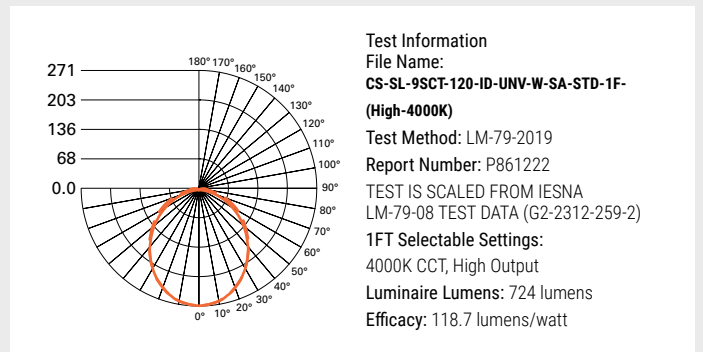
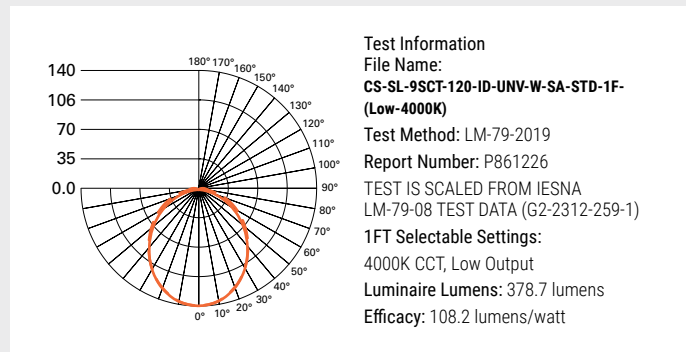

Note: Refer to IES files for complete product data for all CCT and output settings. Full set of IES files are available at [CooperLighting.com](http://CooperLighting.com).

Light Output Conversion Table

CRI	CCT	Low	High
90	2400K	0.45	0.90
	2700K	0.46	0.93
	3000K	0.47	0.95
	3500K	0.48	0.97
	4000K	0.50	1.00

Specifications
>0.9 Power Factor
<20% Total Harmonic Distortion
Average Efficacy > 116 lm/W
-30°C Minimum Ambient Temperature
50°C Maximum Ambient Temperature

**TM-30 DATA FOR 90 CRI, SELECTABLE CCT  
(2400K SETTING)**

ANSI/IES TM-30-18 Color Rendition Report

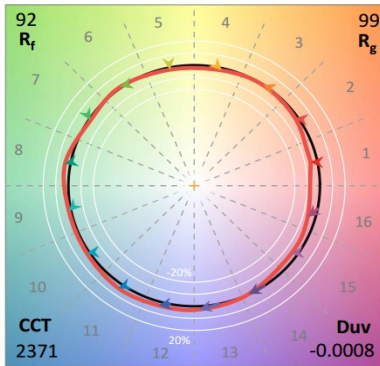

— Reference Illuminant — Test Source

**TM-30 DATA FOR 90 CRI, SELECTABLE CCT  
(2700K SETTING)**

ANSI/IES TM-30-18 Color Rendition Report

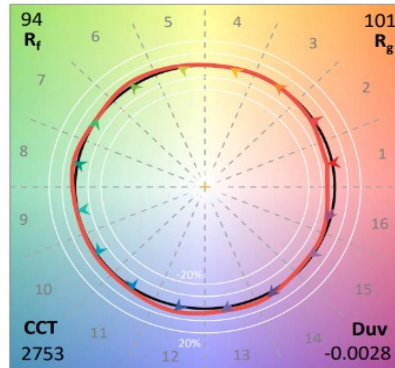

— Reference Illuminant — Test Source

**TM-30 DATA FOR 90 CRI, SELECTABLE CCT  
(3000K SETTING)**

ANSI/IES TM-30-18 Color Rendition Report

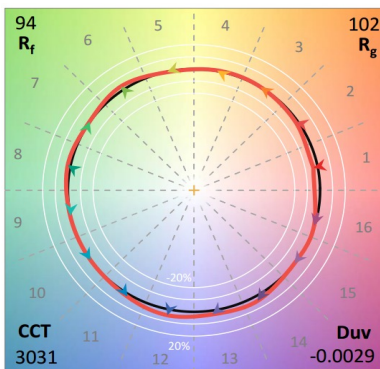

— Reference Illuminant — Test Source

**TM-30 DATA FOR 90 CRI, SELECTABLE CCT  
(3500K SETTING)**

ANSI/IES TM-30-18 Color Rendition Report

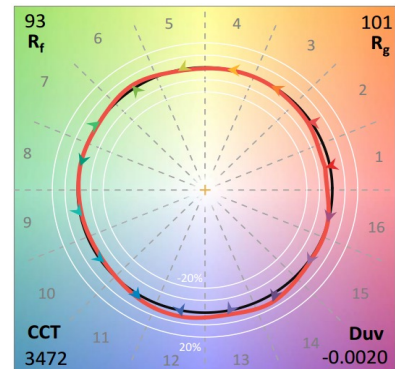

— Reference Illuminant — Test Source

**TM-30 DATA FOR 90 CRI, SELECTABLE CCT  
(4000K SETTING)**

ANSI/IES TM-30-18 Color Rendition Report

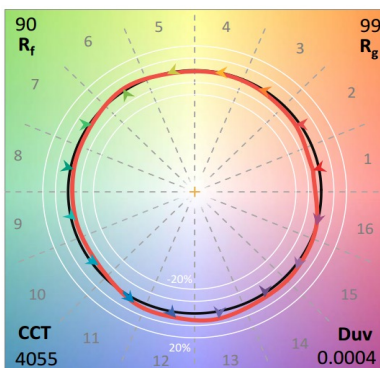

— Reference Illuminant — Test Source

TM-30 data is extrapolated from LM-79 integrating sphere tests. Contact factory for specific TM-30 data.

DCRI	CCT	CRI	R <sub>f</sub>	R <sub>g</sub>	R <sub>9</sub>
90	2400K	92	92	99	55
	2700K	95	94	101	64
	3000K	96	94	102	69
	3500K	95	93	101	70
	4000K	92	90	99	63

## Dimmer Compatability

List of Tested Dimmers		
Manufacturer	Technology	Part Number
EWD (Eaton)	0-10V DC	SF10P-W
EWD (Eaton)	0-10V DC	SF10P-W
Lutron	0-10V DC	DVSTV-WH
Lutron	0-10V DC	IP710-LFZ
EWD (Eaton)	0-10V DC	WBSD-010M-C1

## Mounting and Installation

CovSelect fixtures are designed to connect end-to-end to deliver optimized cove illumination and performance. The dimensions below show adjoining fixtures with the simplistic plug-and-play mechanical and electrical design. The connector includes a snap feature to ensure a secure connection is maintained over time. The release button on the bottom of the connector must be pressed to disconnect the fixtures.

Other mounting and design considerations:

- Mounting location must have solid base / blocking material for secure mount.
- The adjustable mount is designed to secure fixtures in any orientation: direct, indirect, or wall mounted.
- The adjustable mount can be aimed +/- 30 deg in either direction to optimize light distribution for each installation.
- Matte surface finishes in, above and adjacent to cove will deliver optimal volumetric cove light distribution.
- Fixtures should be mounted at least 2" from wall for optimal cove light distribution. See cove design guidelines at right.
- Cove height should be optimized to allow for effective direct light distribution from the cove. See design guidelines at right.
- Jumper cable accessory or corner fixture is required for curves and corners.
- CovSelect is approved for dry or damp installations only.
- The height of the cove face should be designed to hide the fixture from direct view but not interfere with the optical distribution of the light.

## Linear Run Layout / Design

CovSelect fixtures and accessories must be ordered separately. (see details on pg.3).

Orders must include:

1. 1F and 4F fixtures (mounts are included) to cover desired run length.
2. Power harness or control module for line voltage connection (see page 2 for run length limits).
3. Jumper accessories or COR (corner) fixtures are required for any curves or corners.

## Cove Design Guidelines

Optimize cove design details utilizing the considerations at left and the diagram below.

**Note:** Design the cove big enough so the light will wash the intended surface effectively. More space typically results in a more pleasing cove effect. A smaller cove does not produce better illumination and may limit light output distribution. The cove face height should be optimized to hide visibility of the cove fixture while not interfering with the light distribution. See diagram below for reference.

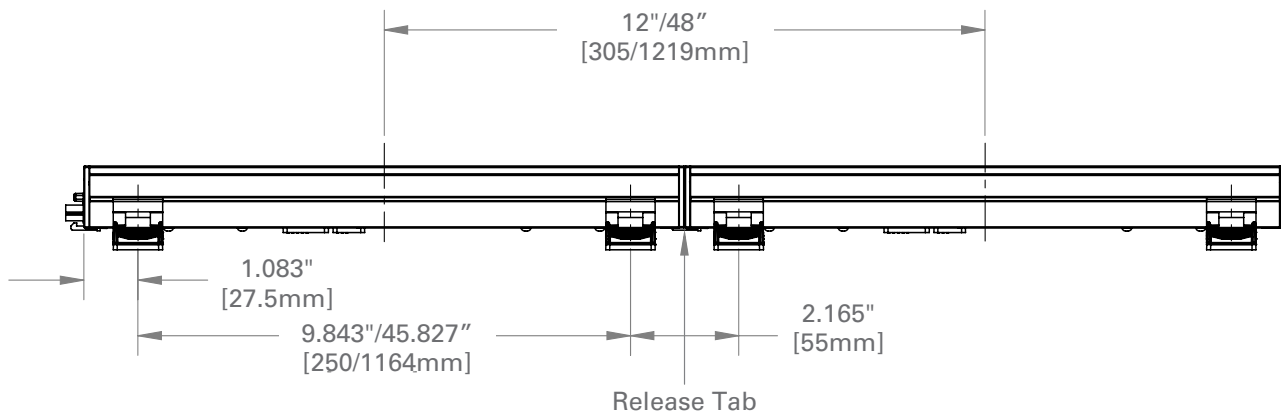
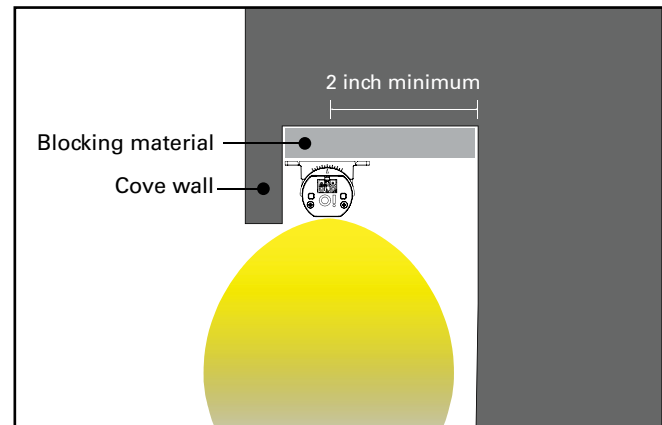
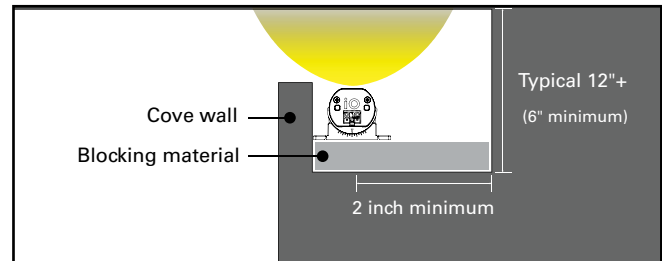



## Run Layout Guidelines

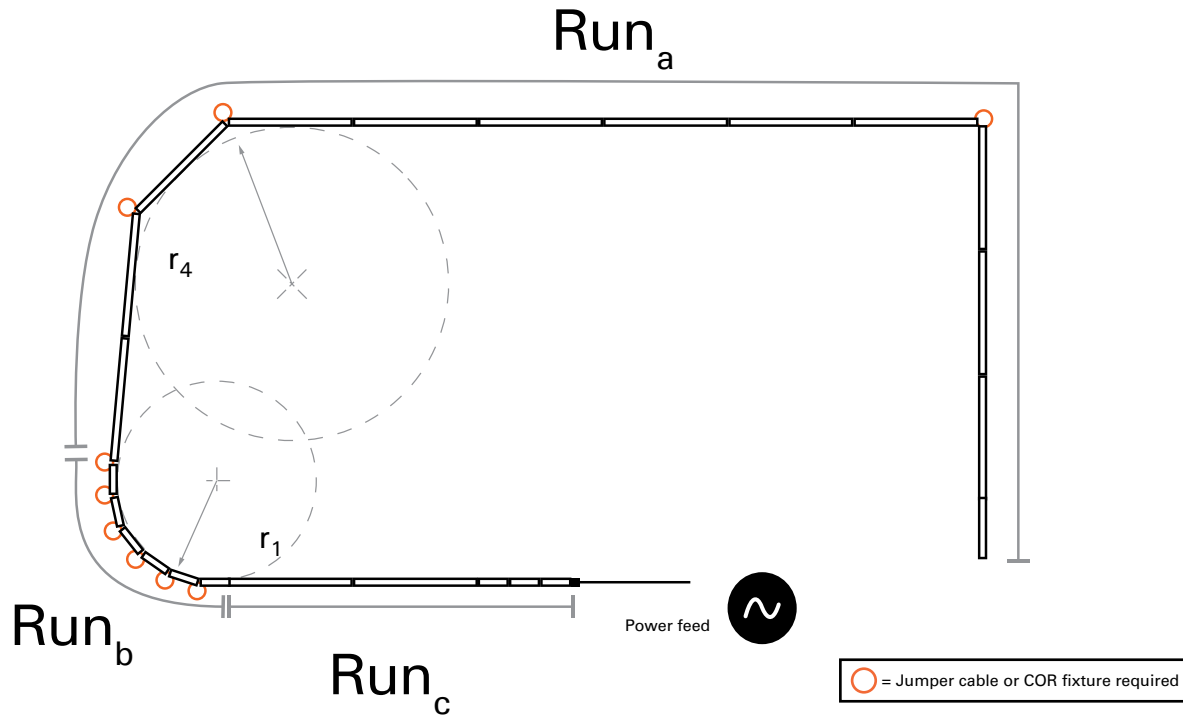

- Run<sub>a</sub> is a 49 ft run and would be ordered as (12) x 4F fixtures + (1) x 1F fixture + (3) x jumpers or corner (COR) fixtures (required for curves and corners)
- Run<sub>b</sub> is a 6 ft curved run and would be ordered as (6) x 1F fixtures + (6) x jumpers or COR (corner fixtures) (for curve) NOTE: If COR fixtures are used (3) x additional 1 ft fixtures would be needed in addition to the COR fixture to replace the 4F fixtures shown
- Run<sub>c</sub> is an 11 ft run with power feed and would be ordered as (2) x 4F fixtures + (3) x 1F fixtures + (1) x power cord
- **Summary:** The entire run shown in the diagram above would be ordered as (14) x 4F fixtures + (10) x 1F fixtures + (9) x jumpers or corner (COR) fixtures + (1) x power cord  
The total run of Run<sub>a</sub>, Run<sub>b</sub>, and Run<sub>c</sub> is 66' in length, hence only (1) x power cord is required (see pg 2 for run length limits)



Dimensions

Corner fixture

CS-SL-9SCT-120-ID-UNV-W-SA-STD-COR

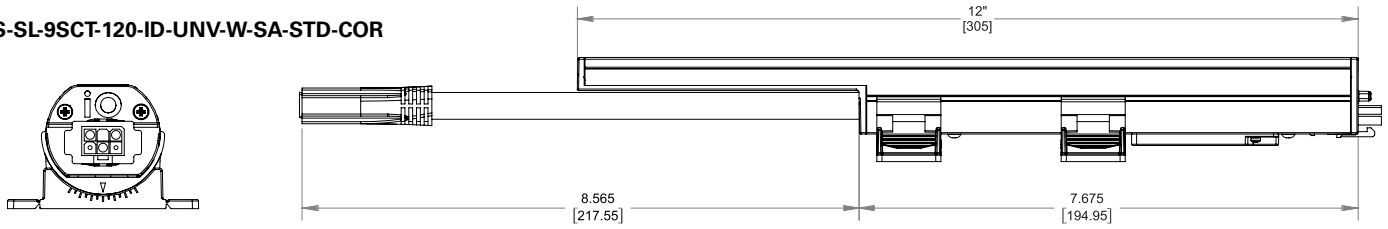

Note: The COR fixture includes an extended 8" power cable with quick connect in place of having the quick connect built into the fixture end cap. This allows for added flexibility of connections between fixtures for corners and curves without the need for jumpers.

The COR fixture enables seamless connections between fixtures with consistent, continuous light distribution for 90 deg corners or curves up to 180 deg.

Without Bracket

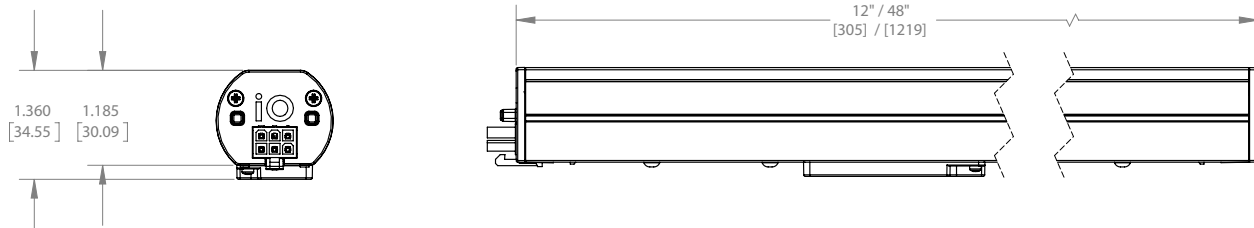

With Bracket

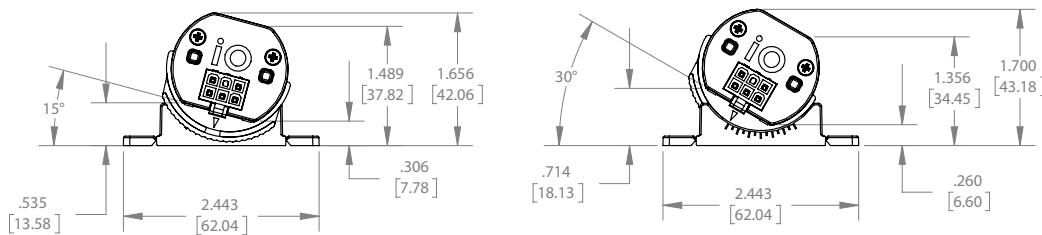

Dimensions

Corner (COR) fixture installation for corners and curves

Note: For any fixtures where fixtures overlap wire harnesses, fixtures will not tilt.

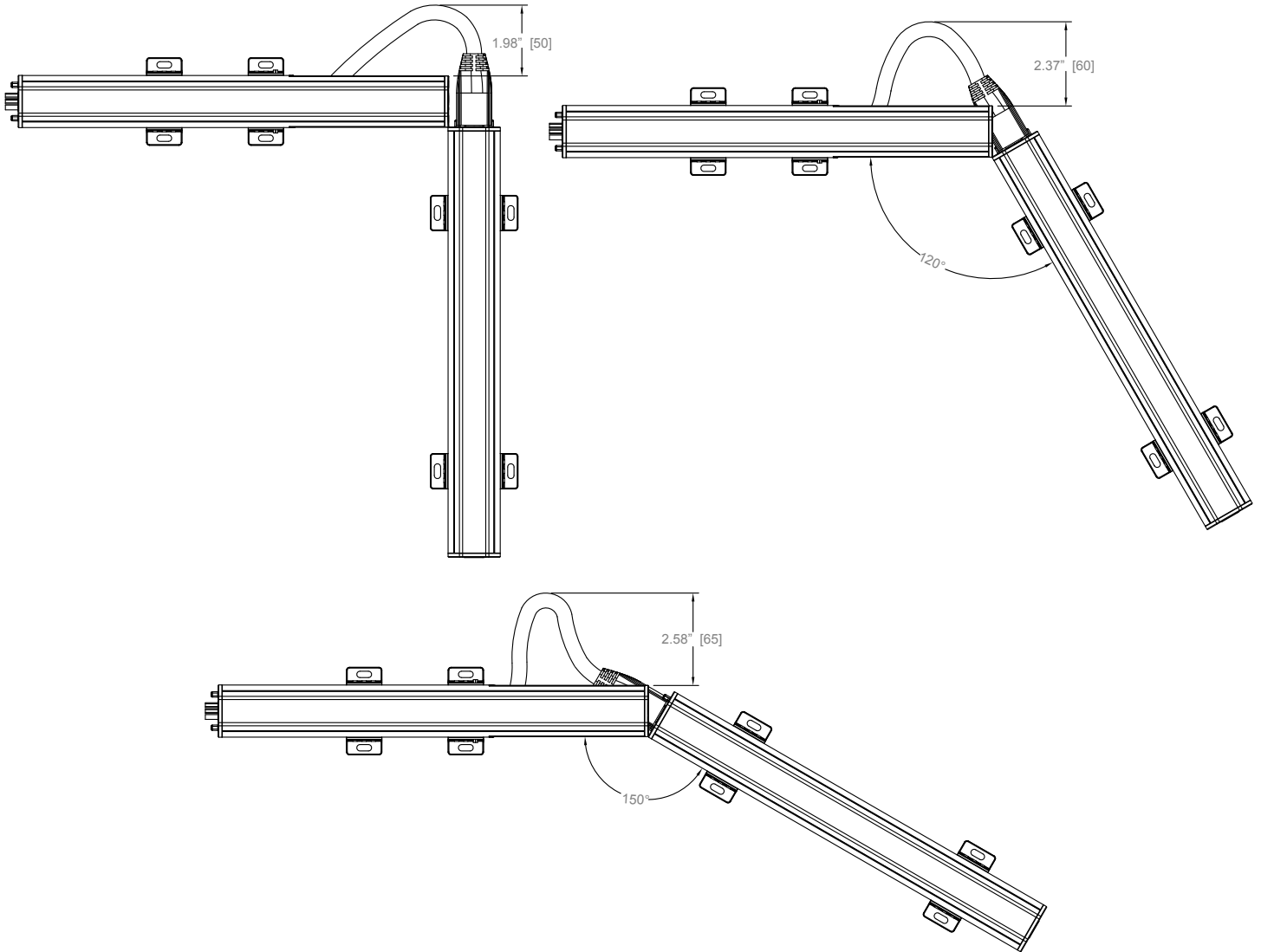

CS-10V-STD - Beginning of Run Power Harness

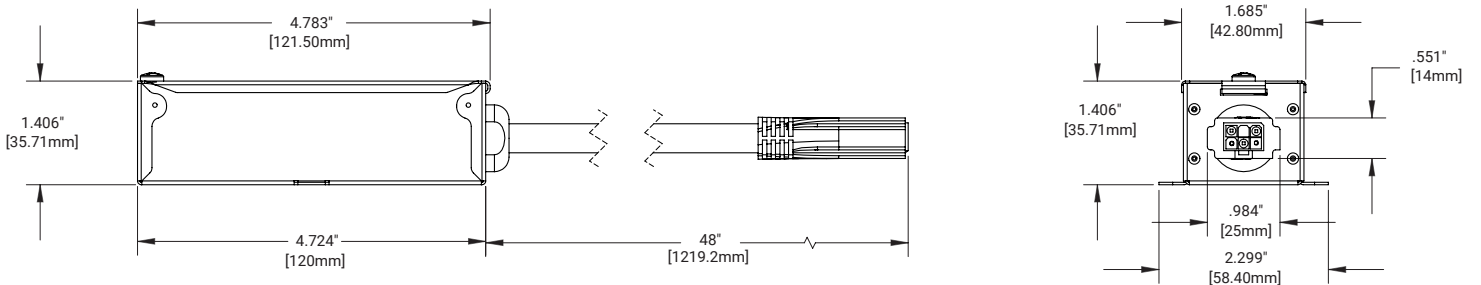

Dimensions

CS-10V-BOX

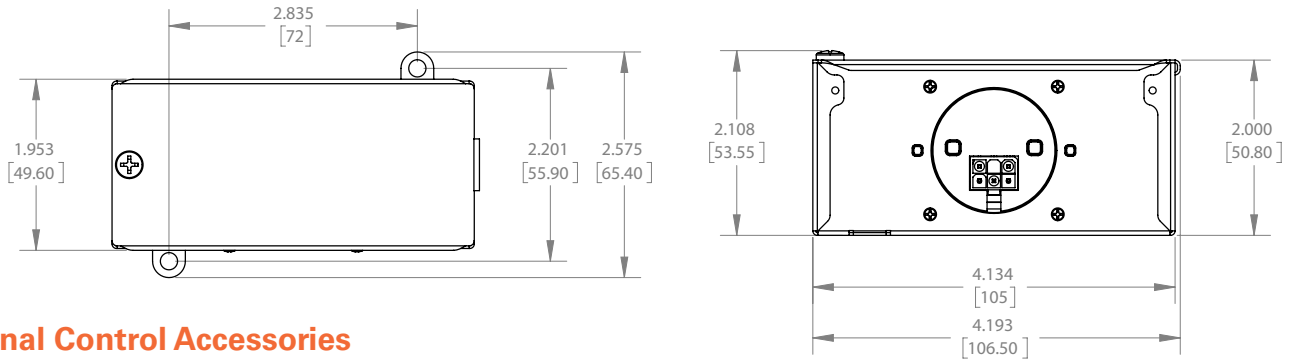

Optional Control Accessories

(for adding to CS-10V-BOX)

DAC-DC1 (for DALI control)

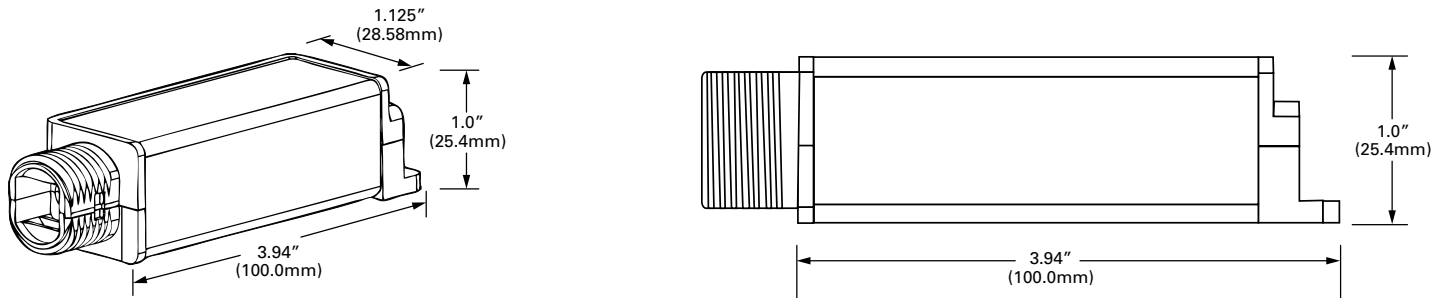

RSP-P-010-347 (for WaveLinx control)

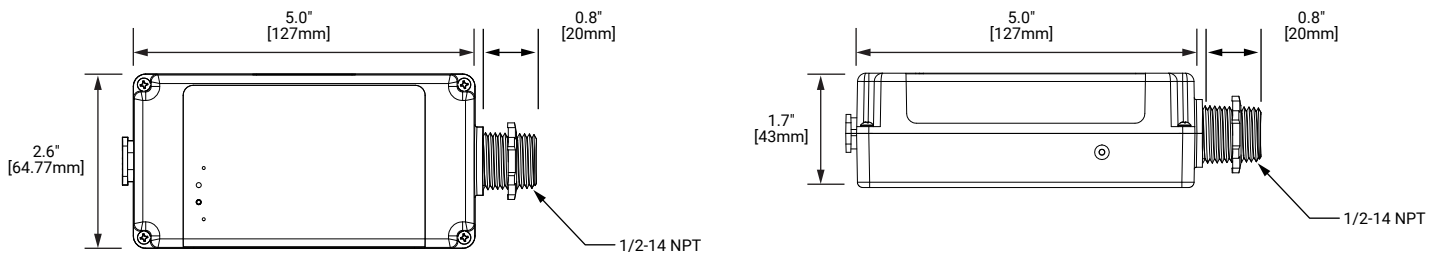

Jumpers (Refer to accessories on pg2.)

