

## EcoSystem® Multiple Control Input Ballasts

Digital electronic dimming ballasts maximize the benefits of a lighting management system. *EcoSystem* Ballasts offer 100% to 10% dimming; ideal for use where saving energy, increasing flexibility, and maximizing productivity are the goals of the lighting design.

### Features

- Continuous, flicker-free dimming from 100% to 10%
- Available with and without an integral sensor connection
- Provides power for and responds to one occupancy sensor, one photo sensor, and one personal control input (infrared receiver or wallstation)
- Integral sensor connection provides power and signal input for one occupancy sensor, one photo sensor, and one personal control (infrared receiver or wallstation)
- Communicates status and sensor inputs over the *EcoSystem* digital link
- Programmed rapid start design ensures full rated lamp life while dimming and cycling
- Lamps turn on to any dimmed level without flashing to full brightness
- Low harmonic distortion throughout the entire dimming range
- Frequency of operation ensures that ballast does not interfere with infrared devices
- End-of-lamp-life protection circuitry ensures safe operation throughout entire lamp life
- Ultra-quiet operation
- Nonvolatile memory restores all ballast settings after power failure
- Ballasts maintain consistent light output for linear lamp lengths (i.e. 4 ft, 3 ft, 2 ft have same relative output)
- Protected from miswires of any input power to control lead, or from lamp leads to each other and/or ground
- 100% performance tested at factory
- Custom ballast factors available.

Design tool and specifications can be found at [www.lutron.com/ballasttool](http://www.lutron.com/ballasttool)



**EcoSystem case type G**



**EcoSystem case type J**

**LUTRON® SPECIFICATION SUBMITTAL**

Page 1

<b>Job Name:</b> <input style="width: 90%; height: 20px;" type="text"/>	<b>Model Numbers:</b> <input style="width: 60%; height: 20px;" type="text"/> <input style="width: 35%; height: 20px;" type="text"/>	
<b>Job Number:</b> <input style="width: 150px; height: 20px;" type="text"/>	<input style="width: 300px; height: 20px;" type="text"/>	<input style="width: 300px; height: 20px;" type="text"/>

## Specifications

### Standards

- California Energy Commission (CEC) Listed
- UL Listed (evaluated to the requirements of UL935)
- CSA certified (evaluated to the requirements of C22.2 No. 74)
- Select ballasts are NOM Listed (contact Lutron for more information)
- S Mark Certified
- Class P thermally protected
- Meets ANSI C82.11 High Frequency Ballast Standard
- Meets FCC Part 18 Non-Consumer requirements for EMI/RFI emissions
- Meets ANSI C62.41 Category A surge protection standards up to and including 4 kV
- Manufacturing facilities employ ESD reduction practices that comply with the requirements of ANSI/ESD S20.20
- Lutron Quality Systems registered to ISO 9001.2000

### Performance

- Operating Voltage: 120, 220/240, 277 V~ at 50 or 60 Hz
- Grounding: ballast and fixture must be grounded for proper dimming
- Dimming Range: 100% to 10% measured relative light output
- Lamp Starting: programmed rapid start
- Lamp Current Crest Factor: less than 1.7
- Light Output Variation: Constant  $\pm 2\%$  light output for line voltage variations of  $\pm 10\%$
- Lamp Life: Average lamp life meets or exceeds specified lamp ratings
- Power Factor: 0.95 minimum
- Total Harmonic Distortion (THD): Less than 10% \*
- Maximum Inrush Current: 3 A per ballast at 277 V~, 7 A per ballast at 120 V~
- Class 2 Output: +20 V $\overline{=}$ , 50 mA maximum (one daylight sensor, one keypad and one occupancy sensor can be connected)

\* Models EC5T514JUNV1 and EC5T817JUNV1 have less than 15% THD

### Environment

- Minimum lamp starting temperature: 50 °F (10 °C)
- Relative humidity: less than 90% non-condensing
- Sound Rating: Class A
- Maximum ballast case temperature: 75 °C (167 °F)

### Ballast Wiring & Mounting

- Ballast is grounded by a mounting screw to the fixture
- Terminal blocks on the ballast accept the following wire gauges:  
Power Wiring, Lamp Wiring, and *EcoSystem* digital link:  
only one 16 or 18 AWG solid per terminal  
Class 2 Sensors:  
only one 22 AWG solid per terminal
- Only one wire per terminal
- Class 2 sensor wiring must be separated from all power and Class 1 wiring, consult all applicable local and national codes
- Ballast mounts using two screws (or sheet metal feature and one screw) within a fluorescent fixture
- Wiring from the ballast to lamp sockets shall not exceed 7 ft for T8, T5, and T5HO lamps
- Wiring from the ballast to lamps sockets shall not exceed 3 ft for T5 Twin Tube lamps

### Lamp Seasoning

Refer to lamp manufacturer for lamp seasoning requirements prior to dimming.

<b>Job Name:</b> <input type="text"/>	<b>Model Numbers:</b> <input type="text"/>	
<b>Job Number:</b> <input type="text"/>	<input type="text"/>	<input type="text"/>

## How to Build a Model Number

### Example

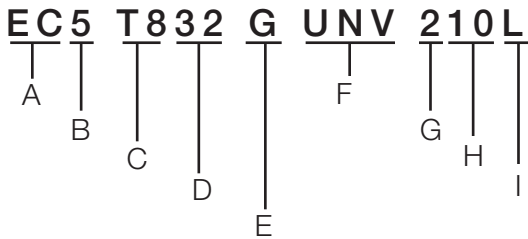

### **A - Type of Ballast**

EC = *EcoSystem*

### **B - Control Type**

5 = 5 control inputs: EcoSystem digital link, 3-wire phase control input, daylight sensor, occupancy sensor, and personal control (IR receiver or wallstation)

### **C - Lamp Size (2 characters)**

T8 or T5

### **D - Lamp Wattage (2 characters)**

XX = Lamp wattage ( i.e. 54 for 54 W lamp)

### **E - Case Type (1 character)**

G or J

### **F - Voltage (3 characters)**

UNV = Universal voltage (120, 220/240, 277 V~)

### **G - Number of Lamps (1 character)**

1, 2, or 3

### **H - Ballast Factor**

Blank = Default (0.85 for T8 and 1.0 for T5)

17 = 1.17 BF

CXX = Custom ballast factor of 0.XX



### **I - Optional Power and Lamp Leads (1 character)**

Blank = No leads

L = Power and lamp leads included (only available on select models in G case)





<b>Job Name:</b> <input type="text"/>	<b>Model Numbers:</b> <input type="text"/>	
<b>Job Number:</b> <input type="text"/>	<input type="text"/>	<input type="text"/>

## EcoSystem® Ballasts with Integral Sensor Connection for linear and U bend T8 Lamps

Lamp	No. of Lamps	Model	Case Size	Input Voltage (VAC)	Input Current (A)	Input Power (W)	Ballast Factor (BF)	System Lumens (lm)	System Efficacy (lm/W)	Ballast Efficacy Factor	Relative Efficacy (RSE)
 F32T8 (48 in)	1	EC5 T832 J UNV 1	J	277	0.11	31.6	0.85	2550	81	2.69	0.86
				240	0.13	31.0	0.85	2550	82	2.74	0.87
				120	0.26	31.3	0.85	2550	81	2.72	0.87
	2	EC5 T832 G UNV 2L	G	277	0.21	59.6	0.85	5100	86	1.43	0.91
				240	0.25	57.6	0.85	5100	89	1.48	0.94
				120	0.49	58.8	0.85	5100	87	1.45	0.93
		EC5 T832 J UNV 2	J	277	0.21	57.4	0.85	5100	89	1.48	0.95
				240	0.25	59.0	0.85	5100	86	1.44	0.92
				120	0.49	59.1	0.85	5100	86	1.44	0.92
	3	EC5 T832 G UNV 3L	G	277	0.31	86.5	0.85	7650	88	0.98	0.94
				240	0.36	84.0	0.85	7650	89	1.01	0.97
				120	0.72	85.9	0.85	7650	89	0.99	0.95
EC5 T832 G UNV 317L		G	277	0.41	105.7	1.17	10,530	100	1.11	1.06	
240	0.47		106.5	1.17	10,530	99	1.10	1.05			
120	0.95	106.8	1.17	10,530	99	1.10	1.05				
 F25T8 (36 in)	1	EC5 T825 J UNV 1	J	277	0.10	27.6	0.85	1828	66	3.08	0.77
				240	0.11	27.0	0.85	1828	68	3.15	0.79
				120	0.23	26.9	0.85	1828	68	3.16	0.79
	2	EC5 T825 J UNV 2	J	277	0.18	48.9	0.85	3665	75	1.74	0.87
				240	0.20	49.0	0.85	3665	75	1.73	0.87
				120	0.41	49.0	0.85	3665	75	1.73	0.87
 F17T8 (24 in)	1	EC5 T817 J UNV 1	J	277	0.08	20.6	0.85	1190	68	4.13	0.70
				240	0.08	20.0	0.85	1190	60	4.25	0.72
				120	0.17	20.1	0.85	1190	70	4.23	0.72
	2	EC5 T817 J UNV 2	J	277	0.13	36.2	0.85	2380	66	2.35	0.80
				240	0.15	37.0	0.85	2380	64	2.30	0.78
				120	0.31	37.0	0.85	2380	64	2.30	0.78







Job Name:	Model Numbers:	
<input type="text"/>	<input type="text"/>	<input type="text"/>
Job Number:	<input type="text"/>	<input type="text"/>

## EcoSystem® Ballasts with Integral Sensor Connection for linear T5 Lamps

Lamp	No. of Lamps	Model	Case Size	Input Voltage (VAC)	Input Current (A)	Input Power (W)	Ballast Factor (BF)	System Lumens (lm)	System Efficacy (lm/W)	Ballast Efficacy Factor	Relative Efficacy (RSE)
F35T5 (57.1 in) 	1	EC5 T535 J UNV 1	J	277	0.15	42.0	1.0	3650	87	2.38	0.83
				240	0.18	42.3	1.0	3650	87	2.38	0.83
				120	0.35	42.2	1.0	3650	87	2.38	0.83
F28T5 (45.2 in) 	1	EC5 T528 J UNV 1	J	277	0.12	32.6	1.0	2900	89	3.07	0.86
				240	0.14	32.9	1.0	2900	88	3.04	0.85
				120	0.27	32.9	1.0	2900	88	3.04	0.85
	2	EC5 T528 J UNV 2	J	277	0.23	64.5	1.0	5800	90	1.55	0.87
				240	0.27	65.0	1.0	5800	89	1.54	0.86
				120	0.54	65.2	1.0	5800	89	1.53	0.86
F21T5 (33.4 in) 	1	EC5 T521 J UNV 1	J	277	0.09	25.8	1.0	2100	81	3.88	0.81
				240	0.12	25.8	1.0	2100	81	3.88	0.81
				120	0.22	25.8	1.0	2100	81	3.88	0.81
	2	EC5 T521 J UNV 2	J	277	0.17	46.0	1.0	4200	91	2.17	0.91
				240	0.20	47.2	1.0	4200	89	2.12	0.89
				120	0.39	47.2	1.0	4200	89	2.12	0.89
F14T5 (21.6 in) 	1	EC5 T514 J UNV 1	J	277	0.07	19.0	1.0	1350	71	5.26	0.74
				240	0.08	19.2	1.0	1350	70	5.21	0.74
				120	0.16	19.2	1.0	1350	70	5.21	0.74
	2	EC5 T514 J UNV 2	J	277	0.12	32.8	1.0	2700	82	3.05	0.85
				240	0.14	33.3	1.0	2700	81	3.00	0.85
				120	0.28	33.3	1.0	2700	81	3.00	0.85





Job Name: <input type="text"/>	Model Numbers: <input type="text"/>	
Job Number: <input type="text"/>	<input type="text"/>	<input type="text"/>

**EcoSystem® Ballasts with Integral Sensor Connection for linear T5 HO Lamps**

Lamp	No. of Lamps	Model	Case Size	Input Voltage (VAC)	Input Current (A)	Input Power (W)	Ballast Factor (BF)	System Lumens (lm)	System Efficacy (lm/W)	Ballast Efficacy Factor	Relative Efficacy (RSE)
F54T5 (45.2 in) 	1	EC5 T554 J UNV 1	J	277	0.21	56.5	1.0	5000	88	1.77	0.96
				240	0.24	58.0	1.0	5000	86	1.73	0.93
				120	0.48	57.9	1.0	5000	86	1.73	0.93
	2	EC5 T554 J UNV 2	J	277	0.40	110.1	1.0	10,000	91	0.91	0.98
				240	0.52	119.0	1.0	10,000	84	0.84	0.91
				120	0.99	119.3	1.0	10,000	84	0.84	0.91
F39T5 (33.4 in) 	1	EC5 T539 J UNV 1	J	277	0.16	43.3	1.0	3500	81	2.31	0.90
				240	0.18	44.0	1.0	3500	80	2.27	0.89
				120	0.37	44.0	1.0	3500	80	2.27	0.89
	2	EC5 T539 J UNV 2	J	277	0.30	83.0	1.0	7000	84	1.20	0.94
				240	0.35	84.0	1.0	7000	83	1.19	0.93
				120	0.70	84.3	1.0	7000	83	1.19	0.93
F24T5 (21.6 in) 	1	EC5 T524 J UNV 1	J	277	0.11	30.0	1.0	2000	67	3.33	0.80
				240	0.13	28.8	1.0	2000	69	3.47	0.83
				120	0.24	28.8	1.0	2000	69	3.47	0.83
	2	EC5 T524 J UNV 2	J	277	0.20	54.8	1.0	4000	73	1.82	0.89
				240	0.23	54.0	1.0	4000	74	1.85	0.89
				120	0.45	53.9	1.0	4000	74	1.86	0.89

Job Name: <input style="width: 90%; height: 20px;" type="text"/>	Model Numbers: <input style="width: 95%; height: 20px;" type="text"/>
Job Number: <input style="width: 80%; height: 20px;" type="text"/>	<input style="width: 95%; height: 20px;" type="text"/>

## EcoSystem® Ballasts with Integral Sensor Connection for T5 Twin Tube Lamps

Lamp	No. of Lamps	Model	Case Size	Input Voltage (VAC)	Input Current (A)	Input Power (W)	Ballast Factor (BF)	System Lumens (lm)	System Efficacy (lm/W)	Ballast Efficacy Factor	Relative Efficacy (RSE)
FT55 (20.7 in)	1	EC5 T555 J UNV 1	J	277	0.20	55.4	0.9	4320	70	1.62	0.89
				240	0.23	55.2	0.9	4320	70	1.63	0.90
				120	0.46	55.2	0.9	4320	70	1.63	0.90
	2	EC5 T555 J UNV 2	J	277	0.40	110.8	0.9	8640	78	0.81	0.99
				240	0.46	110.4	0.9	8640	78	0.82	0.90
				120	0.92	110.4	0.9	8640	78	0.82	0.90
FT50 (22.5 in)	1	EC5 T550 J UNV 1	J	277	0.20	55.4	1.0	4000	72	1.81	0.90
				240	0.23	54.0	1.0	4000	72	1.85	0.93
				120	0.45	54.0	1.0	4000	74	1.85	0.93
	2	EC5 T550 J UNV 2	J	277	0.36	99.7	1.0	8000	80	1.00	1.00
				240	0.42	100.8	1.0	8000	79	0.99	0.99
				120	0.84	100.8	1.0	8000	79	0.99	0.99
FT40 (22.5 in)	1	EC5 T540 J UNV 1	J	277	0.16	44.3	1.0	3100	70	2.26	0.90
				240	0.18	43.2	1.0	3100	72	2.31	0.93
				120	0.36	43.2	1.0	3100	72	2.31	0.93
	2	EC5 T540 J UNV 2	J	277	0.27	74.8	1.0	6200	83	1.34	1.07
				240	0.32	76.8	1.0	6200	81	1.30	1.04
				120	0.64	76.8	1.0	6200	81	1.30	1.04
	3	EC5 T540 G UNV 3L	G	277	0.40	111.3	1.0	9300	84	0.90	1.08
				240	0.47	112.4	1.0	9300	83	0.89	1.07
				120	0.95	113.2	1.0	9300	82	0.88	1.06
FT39 FT36 (15.5 in)	1	EC5 T536 J UNV 1	J	277	0.14	38.8	1.0	2850	74	2.57	0.93
				240	0.17	39.6	1.0	2850	72	2.53	0.91
				120	0.33	39.6	1.0	2850	72	2.53	0.91
	2	EC5 T536 J UNV 2	J	277	0.26	72.0	1.0	5700	79	1.39	1.00
				240	0.31	73.2	1.0	5700	78	1.37	0.98
				120	0.61	73.2	1.0	5700	78	1.37	0.98
FT25 * (22.5 in)	1	EC5 T540 RW J UNV 1	J	277	0.12	34.3	1.0	2600	76	2.91	0.73
				240	0.14	34.5	1.0	2600	75	2.89	0.72
				120	0.28	34.1	1.0	2600	76	2.93	0.73
	2	EC5 T540 RW J UNV 2	J	277	0.21	59.3	1.0	5200	88	1.68	0.84
				240	0.25	61.0	1.0	5200	85	1.64	0.82
				120	0.49	59.3	1.0	5200	88	1.68	0.84

\* Please consult lamp manufacturers spec to determine dimmability of the reduced wattage lamp.

Job Name:	Model Numbers:	
<input type="text"/>	<input type="text"/>	<input type="text"/>
Job Number:	<input type="text"/>	<input type="text"/>

## EcoSystem® Ballast Case Dimensions

### G Case

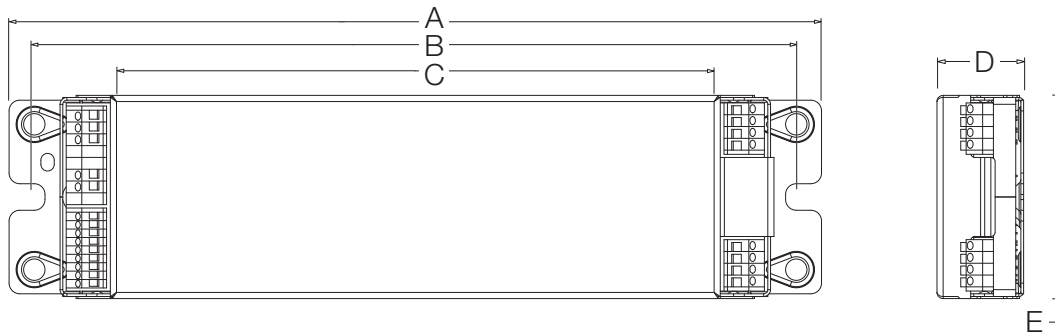

#### G Case Dimensions

A = 9.5 in (241 mm)

B = 8.9 in (226 mm)

C = 7.1 in (180 mm)

D = 1.0 in (25 mm)

E = 2.38 in (60 mm)

G case ballasts with leads ship with 36 in (914 mm) leads for lamp connections and 18 in (457 mm) leads for Hot, Neutral, E1 and E2 connections

### J Case

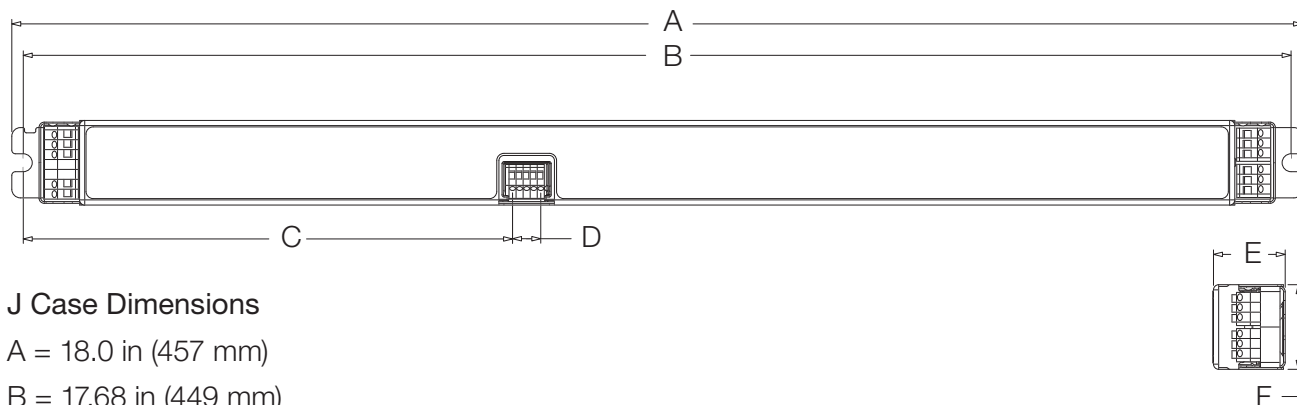

#### J Case Dimensions

A = 18.0 in (457 mm)

B = 17.68 in (449 mm)

C = 6.82 in (173 mm)

D = .394 in (10 mm)

E = 1.0 in (25 mm)

F = 1.18 in (30 mm)

Job Name: <input style="width: 90%;" type="text"/>	Model Numbers: <input style="width: 60%;" type="text"/> <input style="width: 40%;" type="text"/>	
Job Number: <input style="width: 80%;" type="text"/>	<input style="width: 30%;" type="text"/>	<input style="width: 30%;" type="text"/>

### EcoSystem® Ballast Wiring Diagrams - T8, T5, T5 HO

#### Wiring to One Lamp (J case shown)

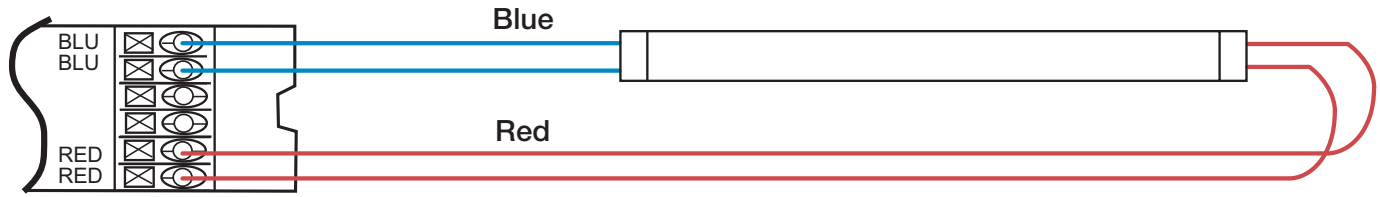

#### Wiring to Two Lamps (J case shown)

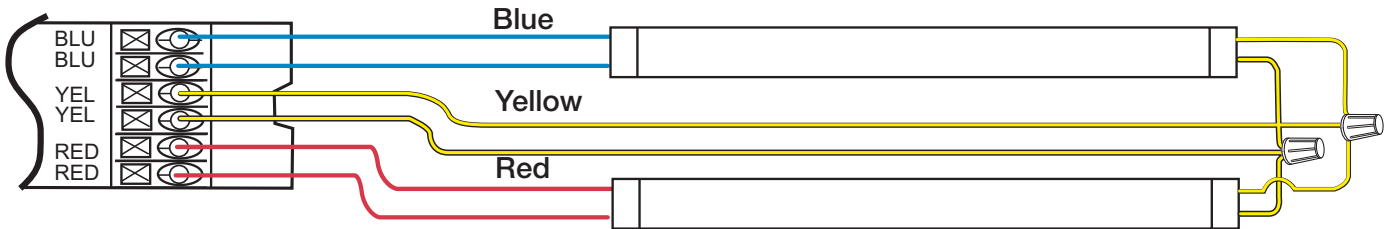

#### Wiring to Two Lamps (G case shown)

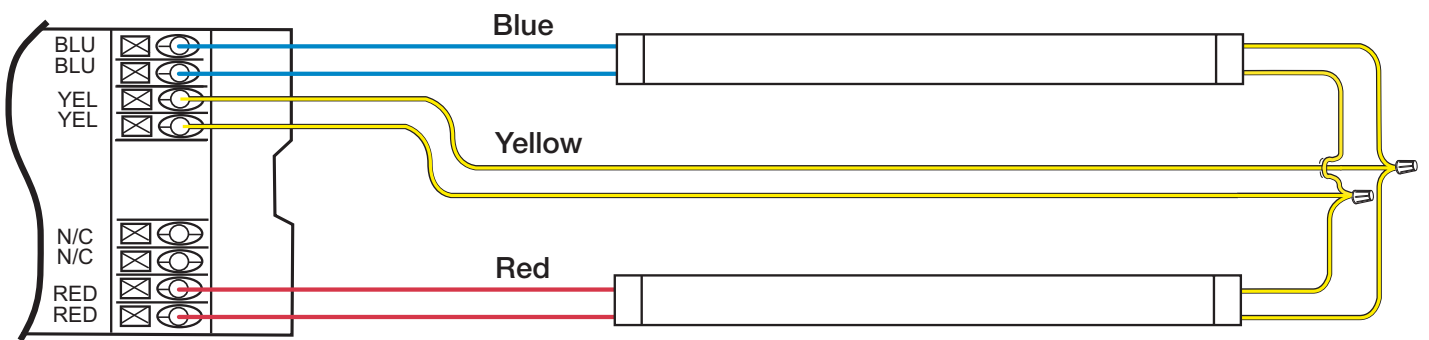

#### Wiring to Three Lamps (G case shown)

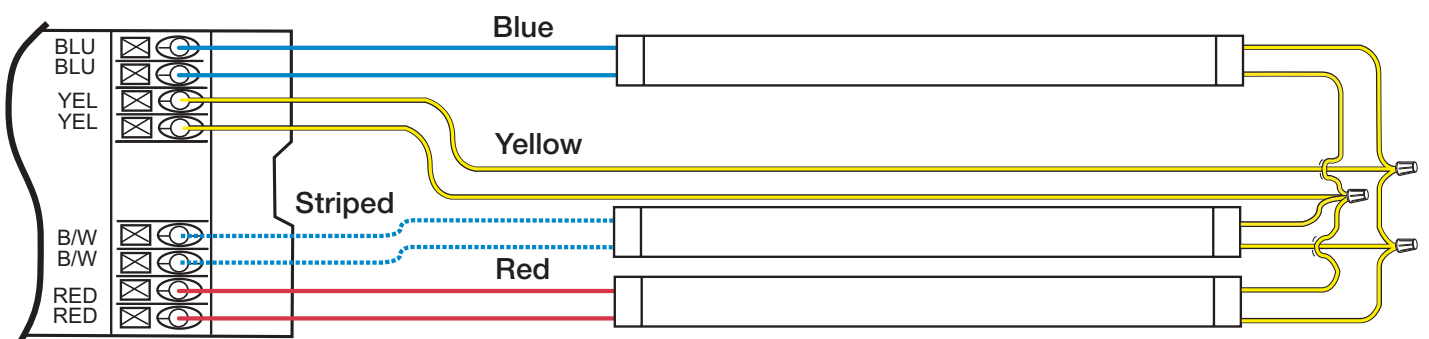

#### NOTICE

- Maximum ballast to lamp socket lead length is 7 ft (2 m)
- Wire colors shown are labeled on the ballast, but may vary depending upon fixture construction

Job Name: <input type="text"/>	Model Numbers: <input type="text"/>	
Job Number: <input type="text"/>	<input type="text"/>	<input type="text"/>

### EcoSystem® Ballast Wiring Diagrams - T5 Twin-Tube

#### Wiring to One Lamp

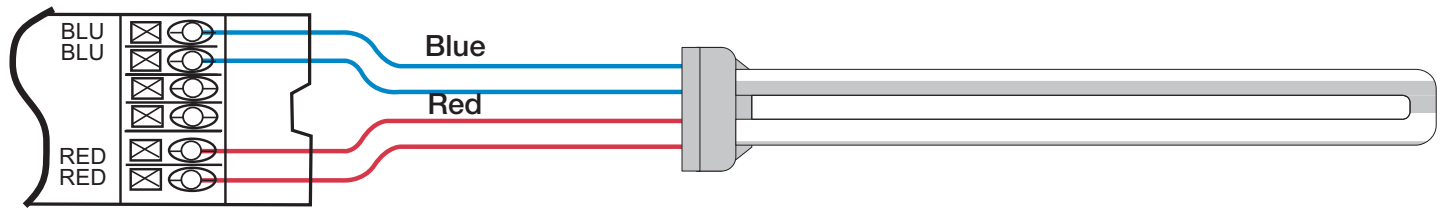

#### Wiring to Two Lamps

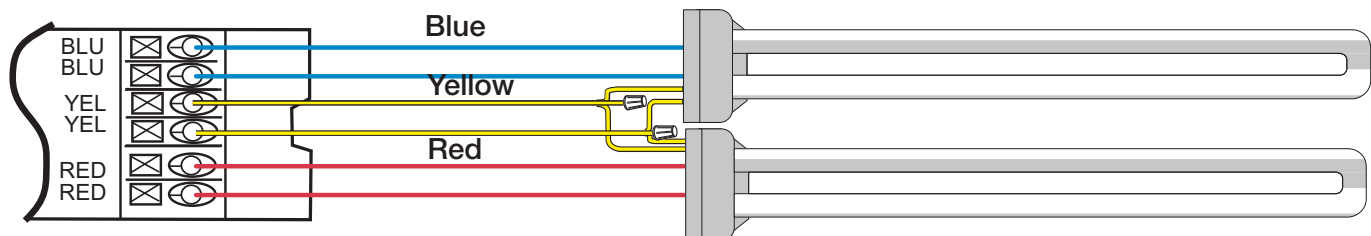

#### NOTICE

- Maximum ballast to lamp socket lead length is 3 ft (1 m)
- Wire colors shown are labeled on the ballast, but may vary depending upon fixture construction

Job Name: <input type="text"/>	Model Numbers: <input type="text"/>	<input type="text"/>
Job Number: <input type="text"/>	<input type="text"/>	<input type="text"/>

## EcoSystem® Ballast Wiring: EcoSystem® Digital Link

### EcoSystem® Digital Link Overview

- The *EcoSystem* digital link wiring (E1 and E2) connects the ballasts together to form a lighting control system.
- Each *EcoSystem* digital link supports up to 64 digital ballasts, 64 occupant sensors, 16 daylight sensors, and 64 wallstations or IR receivers.
- E1 and E2 (*EcoSystem* digital link wires) are polarity insensitive and can be wired in any topology.
- An *EcoSystem* Energi Savr Node™, GRAFIK Eye® QS with *EcoSystem*, or Quantum® system provides power for the *EcoSystem* digital link and supports system programming.
- All *EcoSystem* digital link programming is completed by using the *EcoSystem* Programmer, GRAFIK Eye QS with *EcoSystem*, or *Quantum* system.

### EcoSystem Digital Link Wiring

- Driver *EcoSystem* digital link terminals only accept one solid wire per terminal from 18 to 16 AWG.
- Make sure that the supply breaker to the ballast and *EcoSystem* digital link supply is OFF when wiring.
- Connect the two conductors to the two driver terminals E1 and E2.
- Using two different colors for E1 and E2 will reduce confusion when wiring several ballasts together.
- The *EcoSystem* digital link may be wired Class 1 or Class 2. Consult applicable electrical codes for proper wiring practices.

### Notes

- The *EcoSystem* digital link supply does not have to be located at the end of the digital link.
- E1 and E2 wires are not polarity sensitive.
- *EcoSystem* digital link length is limited by the wire gauge used for E1 and E2 as follows:

Wire Gauge	Digital Link Length (max)
12 AWG	2200 ft
14 AWG	1400 ft
16 AWG	900 ft
18 AWG	550 ft

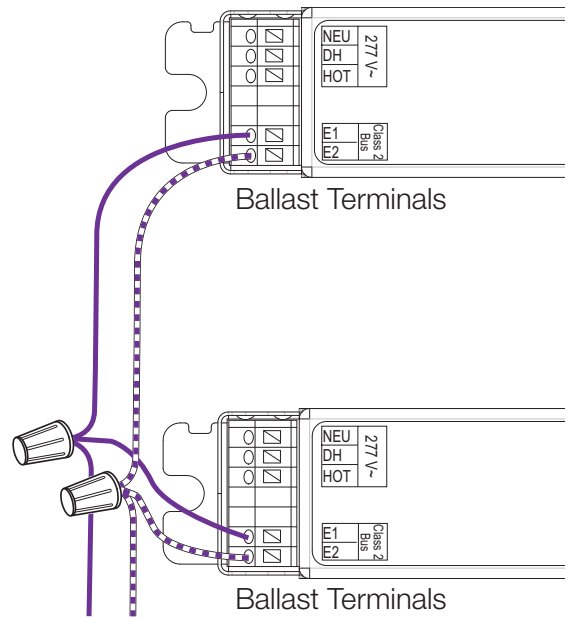

To the *EcoSystem* digital link & up to 64 total ballasts, drivers, or modules

Job Name: <input type="text"/>	Model Numbers: <input type="text"/>	<input type="text"/>
Job Number: <input type="text"/>	<input type="text"/>	<input type="text"/>

## EcoSystem® Ballast Wiring: Class 2 Sensors

### Electrical Contractors and Engineers:

- Always follow applicable national and local electrical code requirements when connecting circuits to *EcoSystem* devices
- All field installed Class 2 wiring must be separated from line voltage wiring by at least 0.25 in (6.4 mm)
- Some local electrical codes require Class 2 wiring to be separately routed in a metal conduit
- Ballast Class 2 Sensor terminals only accept 22 AWG solid conductors; all other terminals accept 18 to 16 AWG solid conductors

### Lutron Requires:

- Keep Class 1 and Class 2 wiring separate.
- Where separation is not possible, use a 600 V insulated cable with an internal shield. Connect the shield to ground to provide better noise immunity for low voltage circuits
- Refer to Application Note #142 for additional information on *EcoSystem* digital link Class 1 and Class 2 wiring

### Fixture Manufacturers:

- UL 1598 6.17.1 allows:  
Factory installed power limited wiring and branch circuit wiring that come in random contact within the luminaire shall have insulation rated for the maximum voltage that exists in any of the circuits. (*EcoSystem* ballast circuits require minimum 600 V insulated wire)
- UL 1598 6.17.2.1 requires:  
Luminaires designed for the field installation of power limited circuits shall be provided with a means of segregating or separating the field-installed power limited circuit wiring from the branch circuit wiring within the luminaire (see UL 1598 6.17 for details)

### Lutron Requires:

- Keep Class 1 and Class 2 wiring separate
- Where separation is not possible, use a 600 V insulated cable with an internal shield. Connect the shield to ground to provide better noise immunity for low voltage circuits

<b>Job Name:</b> <input style="width: 90%; height: 20px;" type="text"/>	<b>Model Numbers:</b> <input style="width: 60%; height: 20px;" type="text"/> <input style="width: 35%; height: 20px;" type="text"/>	
<b>Job Number:</b> <input style="width: 150px; height: 20px;" type="text"/>	<input style="width: 300px; height: 20px;" type="text"/>	<input style="width: 280px; height: 20px;" type="text"/>

# EcoSystem® Ballast Wiring: Daylight Sensor

## Wiring to a Daylight Sensor

- Sensor wiring summary:

Sensor Wire	Ballast Terminal	Terminal Color
Red	+20 V <sub>DC</sub>	Red
Black	Common	Black
White	IR	White
Yellow	Daylight	Yellow

- Make sure that the supply breaker to the Digital Ballast is OFF when wiring.
- Connect the four conductors to the four Digital Ballast terminals as shown.
- Daylight sensor must be placed within 50 ft (15 m) of the ballast.
- Ballast Class 2 terminals only accept one 22 AWG solid wire.

### Notes

- Consult the daylight sensor specification sheet to properly locate the sensor.
- Do not place the sensor above pendant fixtures, directly below lighting fixtures, or within skylight wells.
- When wiring both a wallstation and daylight sensor to one ballast, only connect the IR wire (white) from the keypad. Cap off the white wire from the daylight sensor.
- All sensor and wallstation wiring is Class 2. Follow all applicable national and local codes for proper circuit separation and protection.

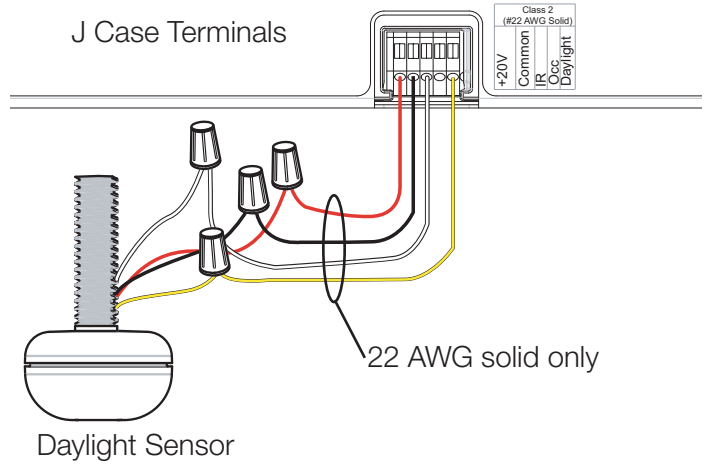
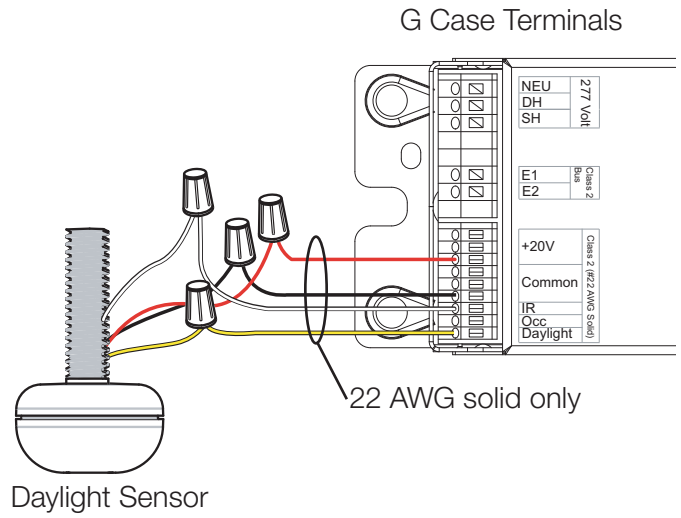

Job Name:	Model Numbers:	
<input type="text"/>	<input type="text"/>	<input type="text"/>
Job Number:	<input type="text"/>	<input type="text"/>

# EcoSystem® Ballast Wiring: Occupancy Sensor

## Wiring to a Lutron Occupant Sensor (LOS-XX)

- Sensor wiring summary:

Sensor Wire	Ballast Terminal	Terminal Color
Red	+20 V $\overline{=}$	Red
Black	Common	Black
Blue	Occ	Blue

- Make sure that the supply breaker to the Digital Ballast is OFF when wiring
- Connect the three conductors to the three ballast terminals as shown
- Occupant sensor must be placed within 50 ft (15 m) of the ballast
- Ballast Class 2 terminals only accept one 22 AWG solid wire

### Notes

- Occupant sensors from other manufacturers may be used with *EcoSystem* ballasts if the sensor meets the following criteria:  
 $V_{in} = +20 V\overline{=}$ , current draw less than 35 mA
- If other manufacturer's occupant sensors are used terminal colors and sensor wire colors may not match
- All sensor and wallstation wiring is Class 2. Follow all applicable national and local codes for proper circuit separation and protection.

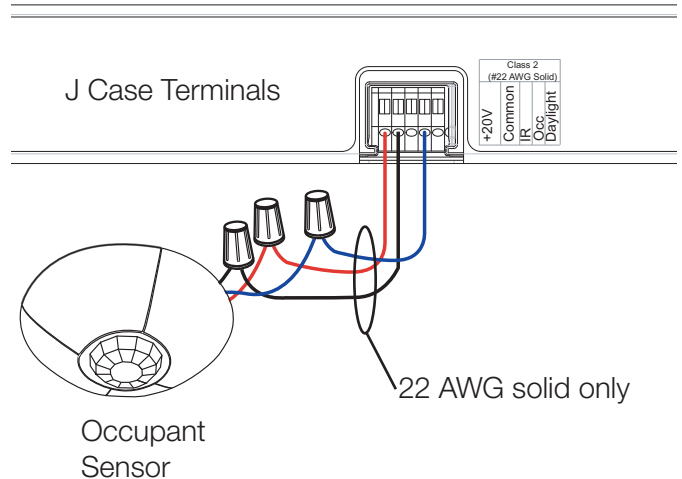
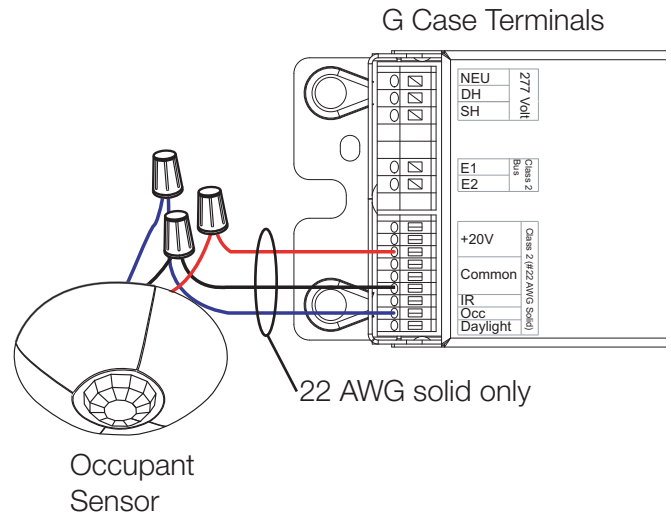

Job Name: <input type="text"/>	Model Numbers: <input type="text"/>	
Job Number: <input type="text"/>	<input type="text"/>	<input type="text"/>

## EcoSystem® Ballast Wiring Diagrams (continued)

### Wiring to an IR Receiver and Wallstation

- Wiring summary:

Sensor Wire	Ballast Terminal	Terminal Color
Red	+20 V===	Red
Black	Common	Black
White	IR	White

- Make sure that the supply breaker to the Digital Ballast is OFF when wiring
- Connect the three conductors to the three Digital Ballast terminals as shown
- Receiver must be placed within 50 ft (15 m) of the ballast
- Ballast Class 2 terminals only accept one 22 AWG solid wire

### Notes

- Only one wallstation or IR receiver can be wired to a digital ballast
- If a daylight sensor and wallstation/IR receiver are connected to one ballast, do not connect the daylight sensor's IR output
- All sensor and wallstation wiring is Class 2. Follow all applicable national and local codes for proper circuit separation and protection.

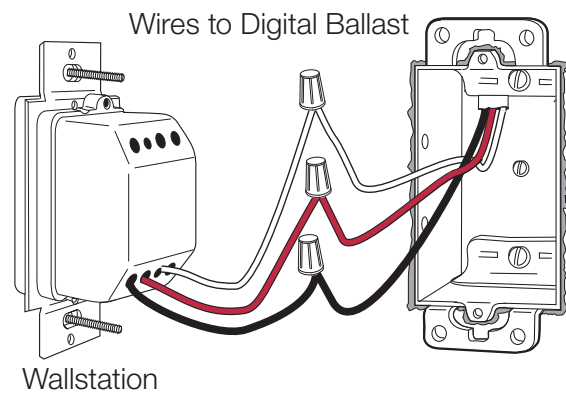
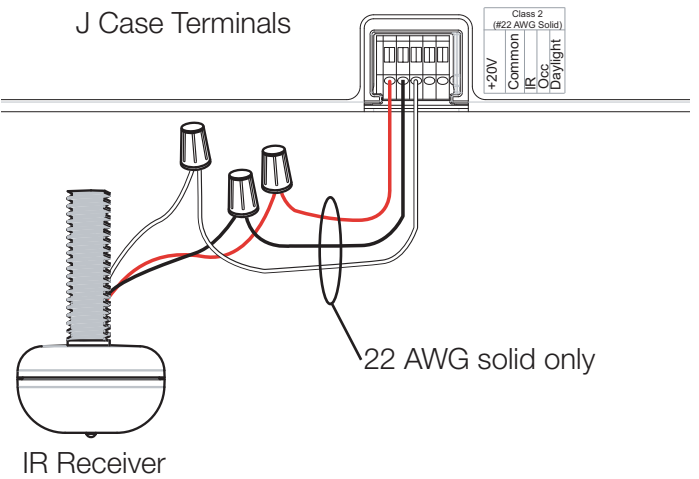
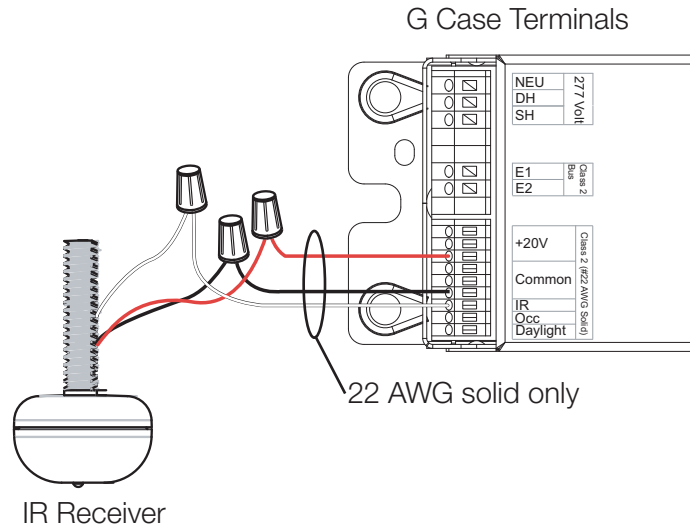

Job Name:	Model Numbers:	
<input type="text"/>	<input type="text"/>	<input type="text"/>
Job Number:	<input type="text"/>	<input type="text"/>

## EcoSystem® Ballast Wiring: Multiple Devices

### Multiple Sensors with One Ballast

- EcoSystem ballasts accept wiring for one daylight sensor input, one occupant sensor input and one IR input (wallstation or IR receiver)
- EcoSystem daylight sensors have IR outputs that allow the device to operate as a programming port. In applications where a daylight sensor and wallstation are wired to the same ballast, do not connect the white wire of the daylight sensor to the ballast. The wallstation operates as the programming port through its integral IR receiver
- Use the chart below as a guide for wiring multiple devices to a ballast

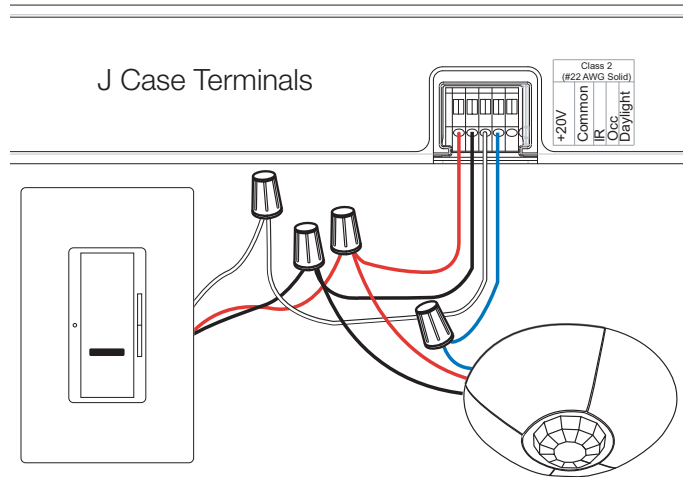

### How to Use the Chart

Connect a sensor to a ballast from the “Devices” column (in bold). Along the selected device row, are “Y’s” and “N’s”. Where a “Y” is placed, the device at the top of that column can also be connected to the same ballast. An “N” indicates no connection allowed.

<b>Devices</b>	<b>Daylight sensor (with IR)</b>	<b>Occupant sensor</b>	<b>Wallstation or IR receiver</b>	<b>Daylight Sensor (no IR)</b>
Daylight sensor (with IR)	/	Y	N	N
Occupant sensor	Y	/	Y	Y
Wallstation or IR Receiver	N	Y	/	Y
Daylight sensor (no IR)	N	Y	Y	/

**Example:** When a Daylight Sensor with IR is connected to a ballast, then only an occupancy sensor can be added for the system to properly function.

Job Name:	Model Numbers:	
<input type="text"/>	<input type="text"/>	<input type="text"/>
Job Number:	<input type="text"/>	<input type="text"/>

## EcoSystem® Ballast Wiring: Line Voltage Dimmers

### EcoSystem Ballasts and 3-wire dimmers

- Lutron 3-wire dimmers only control the ballast they are wired to; *EcoSystem* does not support grouping of 3-wire control input.

### 3-Wire Control Wiring

- Make sure that the supply breaker to the Digital Ballast is OFF when wiring.
- Wire as shown

Line input	Connects to
Hot	Dimmer Black Wire
Neutral	Dimmer White Wire

Dimmer wire	Connects to
Yellow	Ballast Orange (DH)
Red	Ballast Black (HOT)
White	Ballast White (NEU)
Green	Earth Ground

- EcoSystem* ballast line voltage and 3-wire input terminals only accept one 18 to 16 AWG solid wire.

### Emergency and 3-wire

- EcoSystem* ballasts controlled by a wallbox dimmer should not be used for emergency/egress lighting unless an external emergency ballast is used in the fixture. See Lutron Application Note #50.
- EcoSystem* ballasts may be used for emergency/egress lighting when controlled by a Lutron dimming panel (GP); where the panel is a dedicated emergency panel.

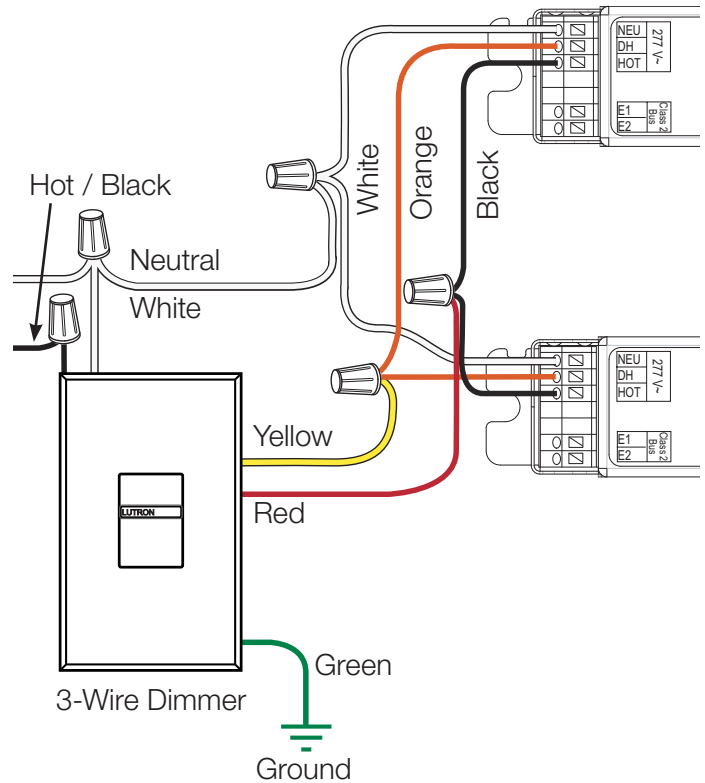

### Notice

3-Wire control turns off digital ballasts when the control is in the off position. The digital ballast inputs (daylight sensor, wallstation, occupant sensor, and IR receiver) will not function when the digital ballast is turned off

Job Name: <input type="text"/>	Model Numbers: <input type="text"/>	<input type="text"/>
Job Number: <input type="text"/>	<input type="text"/>	<input type="text"/>

## Attention Electricians and Fixture Manufacturers

### Ballast/Socket Leads

Lead lengths from ballast to socket must not exceed 7 ft (2 m) for linear lamps (T5, T5HO, T8). Lead lengths must not exceed 3 ft (1 m) for T5 twin tube lamps.

### Lamp Sockets

Lamp sockets as per IEC 60400 are required to ensure positive lamp-pin to socket contact.

### Mounting for T5 and T5HO Lamps

Mount lamps 3/8 in ± 1/8 in (9.5 ± 3.2 mm) away from the grounded metal surface.

### Mounting for T8 & T5 Twin Tube Lamps

Mount lamps 1/2 in ± 1/4 in (13 mm ± 6 mm) away from the grounded metal surface.

Having a lamp too close to the grounded metal will reduce lamp life. Having a fluorescent lamp too far away from the grounded metal will make the lamp flicker or not turn on at all.

### Lamp Seasoning Requirements

Some fluorescent lamp manufacturers recommend that new fluorescent lamps be operated at full output (“seasoned”) before they can be dimmed, to render lamp impurities inert, ensuring proper dimming performance and average rated lamp life. Please contact your lamp manufacturer for seasoning requirements.

### Further Information

For further information please visit [www.lutron.com/ecosystem](http://www.lutron.com/ecosystem) or contact our 24-hour Technical Support Center at 1-800-523-9466.

<b>Job Name:</b> <input type="text"/>	<b>Model Numbers:</b> <input type="text"/>	
<b>Job Number:</b> <input type="text"/>	<input type="text"/>	<input type="text"/>