



Environ - 200W LED Area Light

Order Code: ENV-200CT4-BBZ



Description

Environ LED area lighting fixtures are low profile, low maintenance and feature long life. Perfect for new construction and easy replacement of existing area lighting fixtures. The robust design paired with a variety of mounting options makes them ideal for area/site, roadway, and security applications.

Construction

Rugged die cast housing finished in a durable powder coat finish and with vandal resistant polycarbonate lens. To ensure weather-tight protection, each optical assembly is sealed with a silicone gasket. Luminaires are rated for an ambient operating temperature range of -40°C to 40°C.

Electrical

The Class II power supply has a range of 120-277V, 50/60 Hz or 347-480V input. LED driver is isolated from the LED light engine for enhanced driver reliability. 0-10V DC dimming capability is standard. The luminaires are rated for wet locations. Each fixture has a built-in 10kA surge protector. Each fixture is supplied with a 7-pin receptacle and a shorting cap. A motion sensor can be factory installed.

Mounting

Twistlock photocell accessory can easily be mounted into the fixture. The fixture is designed for use with various mounting accessories: Square and round pole arms, wall mount, slipfitter or mast arm. The slipfitter and the mast arm fit a 2-3/8" tenon. All mounting accessories are ordered separately.

NOTE:

*Lumen maintenance data is based on LED testing per IESNA LM-80-08 and projected per IESNA TM-21-11

Product Performance

Wattage	200W
Lumen Output	25690
Correlated Color Temperature (CCT)	5000K
Color Rendering Index (CRI)	70+
Lumen Maintenance @50,000 hours*	99%
Calculated L70 @ 25°C Ambient in Hours*	>500,000
Distribution	Type 4
Replaces HID Wattage	400W V, 1000W H
Operating Temperature Range	-40°F to 104°F (-40°C to 40°C)

Physical Characteristics

Fixture Color	Bronze
EPA	1.73
Weight	15.7 lbs (7.12kg)
Width	10.25"
Length	19.5"
Height	6.01"

Electrical Characteristics

Input Voltage Range	347-480V
Amperage Draw (Input Volts/Amps)	347/0.55 480/0.40
Surge Protection	10kA

Regulatory Qualifications

cULus Listed, Rated for wet locations

Accessories

EN14178 Round pole straight arm - bronze

EN26814 Square pole mount - bronze

EN35512 Adjustable slipfitter - bronze

EN38419 Mast arm - bronze

EN47832 Wall mount - bronze

PH81156 3-Pin Twist lock photocell (480V)

PH87145 3-pin Twist lock photocell (347V)

PH81975 Replacement shorting cap

Add suffix "-M34" to order code for a factory installed fixture with a Motion/Dim/Photocell Sensor

Add suffix "-SH" to order code for a factory installed fixture with backlight shield

Add suffix "-SHM12" to order code for a factory installed fixture with backlight shield & Motion/Dim/Photocell sensor

SP12826 – 347-480V Surge Protector



Venture Environ - 200W LED Area Light

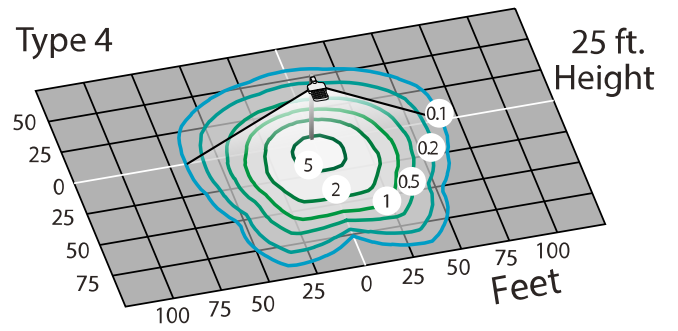
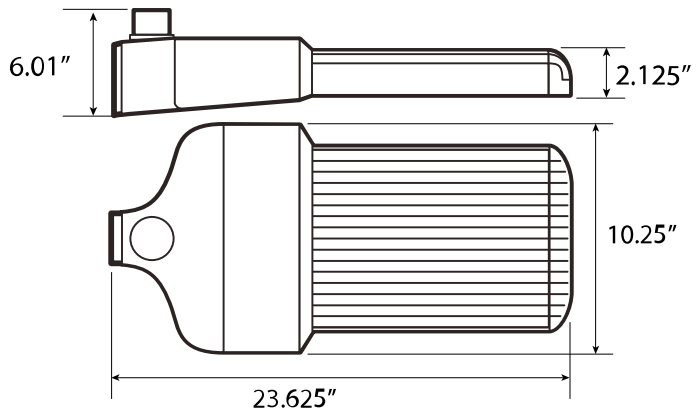

PH81975



EN26814



EN38419



EN14178



EN35512



EN47832

Accessories

