



**Hi-lume Ballast Models**

Lamp Type				120 VOLTS		277 VOLTS	
	Lamp Watts (length)	Lamps per ballast	Case Type	Ballast Current (amps)	Hi-lume Model Number	Ballast Current (amps)	Hi-lume Model Number
<b>T4 Triple-tube 4-pin</b>  1/2 in. diameter	26 W	1	A	.26	HL3-T426-120-1-S <sup>1</sup>	.12	HL3-T426-277-1-S <sup>1</sup>
	32 W	1	A	.31	HL3-T432-120-1-S <sup>1</sup>	.13	HL3-T432-277-1-S <sup>1</sup>
<b>T5-HO Linear High Output</b>  5/8 in. diameter	24 W (21.5 in)	1	C	.31	FDB-T524-120-1	.15	FDB-T524-277-1
		2	C	.62	FDB-T524-120-2	.24	FDB-T524-277-2
	39 W (33.4 in)	1	C	.38	FDB-T539-120-1	.19	FDB-T539-277-1
		2	C	.76	FDB-T539-120-2	.32	FDB-T539-277-2
	54 W (45.3 in)	1	C	.58	FDB-T554-120-1	.25	FDB-T554-277-1
		2	C	1.1	FDB-T554-120-2	.45	FDB-T554-277-2

<sup>1</sup> Mounting studs standard for T4 ballasts. Delete suffix -S in the model number if mounting studs not needed.

<b>Job Name:</b>	<b>Model Numbers:</b>
<b>Job Number:</b>	

Case Dimensions

A<sup>1</sup>

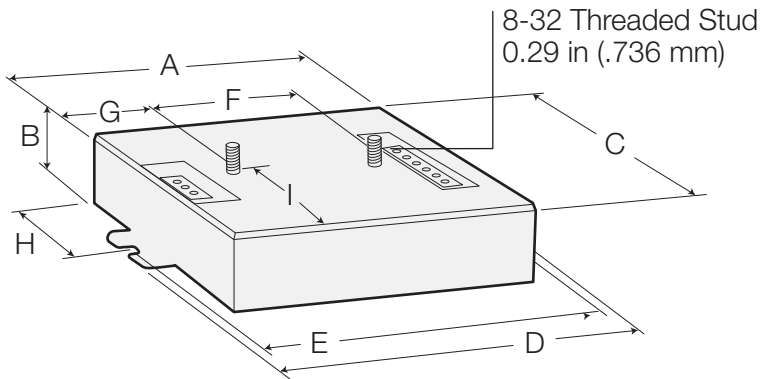

A	4.20 in (107 mm)
B	1.00 in (25 mm)
C	3.00 in (76 mm)
D	4.90 in (124 mm)
E	4.60 in (117 mm)
	(mounting centers)
F	2.00 in (51 mm)
G	1.08 in (27 mm)
H	1.60 in (41 mm)
I	1.39 in (35 mm)

C

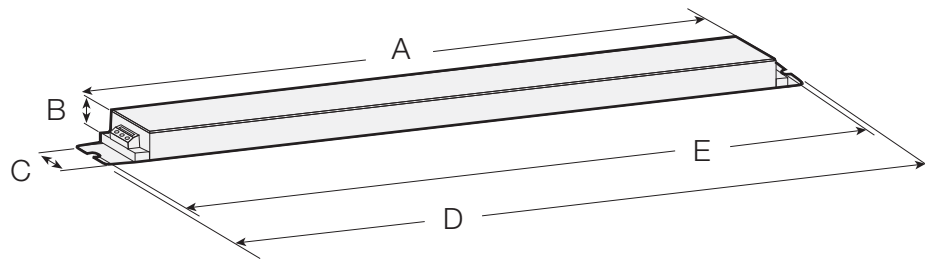

A	16.12 in (409 mm)
B	1.00 in (25 mm)
C	1.18 in (30 mm)
D	18.00 in (457 mm)
E	17.70 in (450 mm)
	(mounting centers)

<sup>1</sup> Mounting studs standard. When ordering, delete suffix -S in the ballast model number if mounting studs not needed.

Job Name:	Model Numbers:
Job Number:	

# Wiring Diagram

## One Compact Fluorescent Lamp

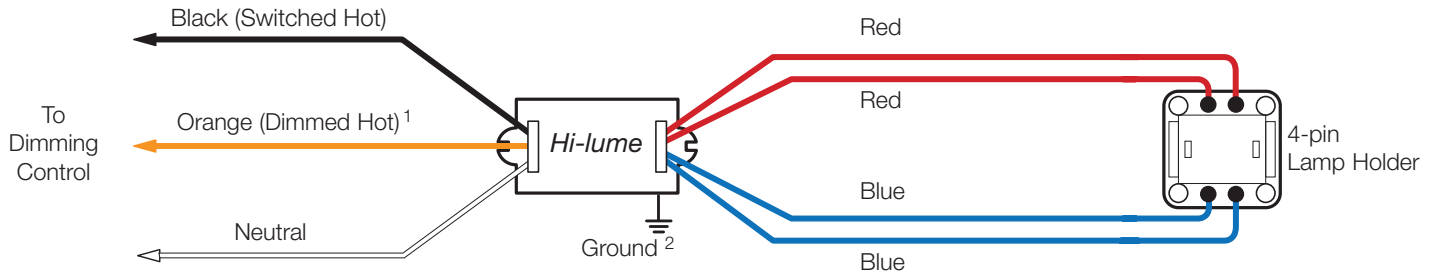

<sup>1</sup> Dimming control wire colors may not match ballast wire colors (e.g. control “dimmed hot” may be yellow and ballast “dimmed hot” may be orange). Wire colors shown are for Lutron controls and ballasts only.

<sup>2</sup> Ballast and lighting fixture must be grounded.

**Note:** For T4 compact lamps, maximum lamp-to-ballast wire length is 3 feet (1 m).

Job Name:	Model Numbers:
Job Number:	

## Wiring Diagrams

### One T5-HO Lamp

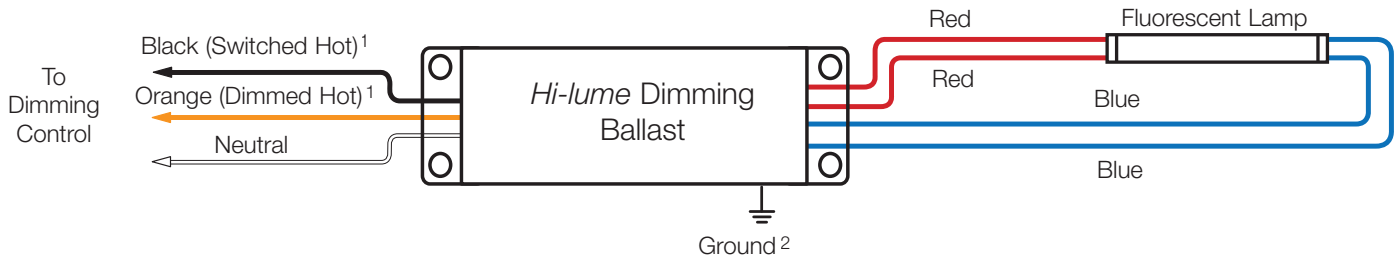

### Two T5-HO Lamps

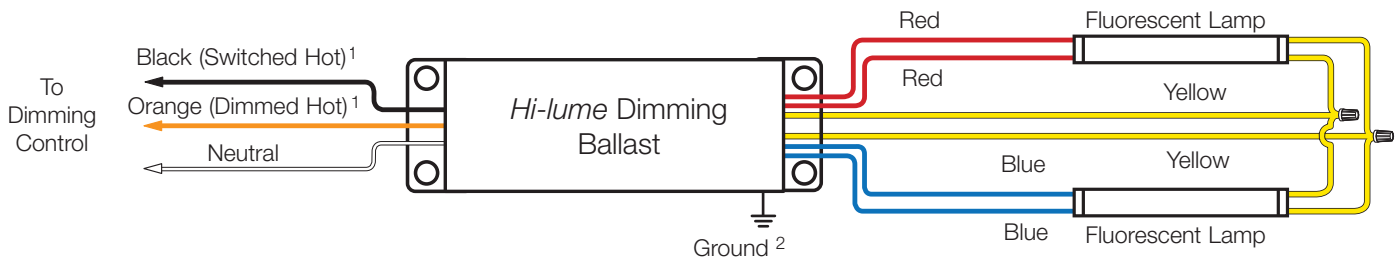

<sup>1</sup> Dimming control wire colors do not necessarily match ballast wire colors (e.g. control “dimmed hot” may be yellow, and ballast “dimmed hot” may be orange). Wire colors shown are for Lutron ballasts and controls only.

<sup>2</sup> Ballast and lighting fixture must be grounded.

**Note:** For T5-HO lamps, maximum lamp-to-ballast wire length is 7 feet (2 m).

Job Name:	Model Numbers:
Job Number:	



**ATTENTION ELECTRICIANS AND CONTRACTORS**

**Ballast/Socket Leads**

Lead lengths from ballast to socket must not exceed 7 ft. (2 m) for T5-HO lamps, and 3 ft. (1 m) for T4 compact lamps.

**Lamp Sockets**

Lamp sockets as per IEC 60400 are required to ensure positive lamp-pin to socket contact. T5 linear lamps require rotary locking sockets.

**Lamp Mounting for T5 and T5-HO**

Keep lamps 3/8 in. ± 1/8 in. away from the grounded metal surface.

Having a T5-HO lamp too close to the grounded metal may cause a visible difference in brightness along the length of the lamp.

**Ballast Operating Temperature**

Ballast case temperature must not exceed 75 °C at any point on ballast.

**Wiring and Grounding**

Ballast and lighting fixture must be effectively grounded. Ballasts must be installed per national and local electrical codes.



**ATTENTION FACILITIES MANAGERS**

**PERFORMANCE**

**Lamp Seasoning**

Some fluorescent lamp manufacturers recommend that new fluorescent lamps be operated at full output (“seasoned”) before they can be dimmed, to render lamp impurities inert, ensuring proper dimming performance and average rated lamp life. Please contact your lamp manufacturer for seasoning requirements.

**SERVICE**

**Replacement Parts**

Use replacement parts with exact Lutron model numbers. Consult Lutron if you have any questions.

**Further Information**

For further information, please visit us at [www.lutron.com/ballasts](http://www.lutron.com/ballasts) or contact our 24-hour Technical Support Center at 1-800-523-9466.

<p>Job Name:</p>  <p>Job Number:</p>	<p>Model Numbers:</p>
--	-----------------------