

## LED Luminaires

### ProLED Select Slim Downlight Series

- Five Selectable Color Temperatures
- 90+ CRI for Superior Color Rendering
- Wet Location Rated for Greater Application Flexibility
- Low Profile Design
- Triac Dimming to 10%

### Specifications



### Description

The ProLED Select Slim Downlight Series provides an ultra-slim solution for shallow plenum spaces in both new construction and retrofit downlighting applications. This product features five selectable color temperatures, 90+ CRI and a low glare output to provide a high performing and simple solution for any lighting project.

### Performance

- Selectable color temperatures 2700K, 3000K, 3500K, 4500K, 5000K
- Provides uniform diffused light
- Low glare
- High CRI - 90+
- L70 lumen maintenance > 50,000 hours
- 5 Year limited warranty
- Dimmable to 10%
- 120VAC input

### Construction

- Simple installation - no additional housing or junction box required
- Low profile design and remote driver enclosure ideal for shallow plenums
- Spring loaded universal mounting slips ensure secure fit to ceiling
- IC rated steel junction box w/ (2) 3/4" knockouts
- Robust die cast aluminum construction
- Color select dip switch on driver enclosure
- 12" Cable connector between led module and driver compartment

### Certifications

- ETL listed
- Energy Star certified
- IC rated
- Wet location
- Title 24 compliant

DATE:  LOCATION:

TYPE:  PROJECT:

CATALOG #:

LED Luminaires

## ProLED Select Slim Downlight Series

### Ordering Logic

Series	Product Size	Lens	Wattage	Shape	CCT	Technology	Pack Quantity
FSDLS = Downlight Slim	3 = 3 Inch 4 = 4 Inch 5 = 5 Inch 6 = 6 Inch 8 = 8 Inch	FR = Frosted	8 = 6W 10 = 8W 12 = 10W or 11W 15 = 13W 18 = 18W	Blank = Round SQ = Square	CCT = Color Selectable 2700K/3000K/3500K/ 4000K/5000K	LED = LED	Blank = Single Pack 4 PK = 4 Pack*

\*4 PK only available in 4" and 6" Round Slim Downlights

### Ordering Information

Product SKU	Product Code	Product Description	Energy Star ID
89152	FSDLS3FR8/CCT/LED	ProLED Select Slim Downlight 3" 6W CCT Selectable	3890368
89093	FSDLS4FR10/CCT/LED	ProLED Select Slim Downlight 4" 8W CCT Selectable	3890364
89153	FSDLS5FR12/CCT/LED	ProLED Select Slim Downlight 5" 10W CCT Selectable	3891050
89094	FSDLS6FR12/CCT/LED	ProLED Select Slim Downlight 6" 11W CCT Selectable	3890369
89095	FSDLS6FR15/CCT/LED	ProLED Select Slim Downlight 6" 13W CCT Selectable	3891046
89106	FSDLS8FR18/CCT/LED	ProLED Select Slim Downlight 8" 18W CCT Selectable	3891051
89096	FSDLS4FR10/SQ/CCT/LED	ProLED Select Slim Downlight 4" 8W CCT Selectable	3890366
89097	FSDLS6FR12/SQ/CCT/LED	ProLED Select Slim Downlight 6" 11W CCT Selectable	3891045
89098	FSDLS6FR15/SQ/CCT/LED	ProLED Select Slim Downlight 6" 13W CCT Selectable	3891047
89140	FSDLS4FR10/CCT/LED/4PK	ProLED Select Slim Downlight 4" 8W CCT Selectable 4 Pack	3890365
89141	FSDLS6FR12/CCT/LED/4PK	ProLED Select Slim Downlight 6" 11W CCT Selectable 4 Pack	3890370

#### Accessories

89154	DFDLS3-RT-RD-BK	ProLED Select Direct Fit Slim Downlight 3" Round Replaceable Trim Black
89120	DFDLS4-RT-RD-BK	ProLED Select Direct Fit Slim Downlight 4" Round Replaceable Trim Black
89155	DFDLS5-RT-RD-BK	ProLED Select Direct Fit Slim Downlight 5" Round Replaceable Trim Black
89121	DFDLS6-RT-RD-BK	ProLED Select Direct Fit Slim Downlight 6" Round Replaceable Trim Black
89122	DFDLS8-RT-RD-BK	ProLED Select Direct Fit Slim Downlight 8" Round Replaceable Trim Black
89158	DFDLS3-RT-RD-SN	ProLED Select Direct Fit Slim Downlight 3" Round Replaceable Trim Satin Nickel
89123	DFDLS4-RT-RD-SN	ProLED Select Direct Fit Slim Downlight 4" Round Replaceable Trim Satin Nickel
89159	DFDLS5-RT-RD-SN	ProLED Select Direct Fit Slim Downlight 5" Round Replaceable Trim Satin Nickel
89124	DFDLS6-RT-RD-SN	ProLED Select Direct Fit Slim Downlight 6" Round Replaceable Trim Satin Nickel
89125	DFDLS8-RT-RD-SN	ProLED Select Direct Fit Slim Downlight 8" Round Replaceable Trim Satin Nickel
89162	DFDLS3-RT-RD-BZ	ProLED Select Direct Fit Slim Downlight 3" Round Replaceable Trim Bronze
89126	DFDLS4-RT-RD-BZ	ProLED Select Direct Fit Slim Downlight 4" Round Replaceable Trim Bronze
89163	DFDLS5-RT-RD-BZ	ProLED Select Direct Fit Slim Downlight 5" Round Replaceable Trim Bronze
89127	DFDLS6-RT-RD-BZ	ProLED Select Direct Fit Slim Downlight 6" Round Replaceable Trim Bronze
89128	DFDLS8-RT-RD-BZ	ProLED Select Direct Fit Slim Downlight 8" Round Replaceable Trim Bronze
89142	ACC-NCP-ABH-4R	4" Round NC Pan with Adjustable Bar Hangers
89143	ACC-NCP-ABH-6R	6" Round NC Pan with Adjustable Bar Hangers
89129	DFDLS-RP-468-RD	ProLED Select Direct Fit Slim Downlight Adjustable Rough In Pan 4", 6", 8"
89166	FSDLS/RP3RD	ProLED Select Direct Fit Slim Downlight Rough In Pan 3"
89104	FSDLS/RP4RD	ProLED Select Direct Fit Slim Downlight Rough In Pan 4"
89167	FSDLS/RP5RD	ProLED Select Direct Fit Slim Downlight Rough In Pan 5"
89105	FSDLS/RP6RD	ProLED Select Direct Fit Slim Downlight Rough In Pan 6"
89102	FSDLS/EXT12	ProLED Select Direct Fit Slim Downlight Extension Cable 12"

## ProLED Select Slim Downlight Series

### Specifications Table

	FSDLS3FR8/ CCT/LED	FSDLS4FR10/ CCT/LED	FSDLS5FR12/ CCT/LED	FSDLS6FR12/ CCT/LED	FSDLS6FR15/ CCT/LED	FSDLS8FR18/ CCT/LED	FSDLS4FR10/ SQ/CCT/LED	FSDLS6FR12/SQ/ CCT/LED	FSDLS6FR15/ SQ/CCT/LED
<b>Nominal Wattage</b>	6W	8W	10W	11W	13W	18W	8W	11W	13W
<b>Delivered Lumens</b>	504 - 537	749 - 777	863 - 907	927 - 978	1105 - 1163	1712 - 1768	649 - 730	1040 - 1089	1159 - 1199
<b>Efficacy (lm/W)</b>	85 - 92	90 - 101	89 - 95	85 - 91	87 - 93	96 - 101	85 - 94	96 - 102	93 - 99
<b>CCT</b>	Selectable - 2700K, 3000K, 3500K, 4000K, 5000K								
<b>CRI</b>	90+								
<b>L70 Lifetime (hrs)</b>	50,000								
<b>Voltage</b>	120VAC								
<b>Power Factor</b>	>0.9								
<b>Dimming</b>	Triac Dimming to 10%								
<b>Housing Material</b>	Aluminum								
<b>Driver Housing Material</b>	Steel								
<b>Operating Temperature</b>	-20°C - 140°C								
<b>Listings</b>	ETL, Energystar, Title 24, JA-8								
<b>Environment</b>	UL, Wet Location, IC Rated								
<b>Warranty</b>	5 Years Standard								

### Performance Table

Product Code	Selectable Wattage	2700K		3000K		3500K		4000K		5000K	
		Lumen (lm)	Efficacy (lm/W)	Lumen (lm)	Efficacy (lm/W)	Lumen (lm)	Efficacy (lm/W)	Lumen (lm)	Efficacy (lm/W)	Lumen (lm)	Efficacy (lm/W)
FSDLS3FR8/CCT/LED	6W	504	85	511	88	537	92	534	91	526	89
FSDLS4FR10/CCT/LED	8W	749	90	768	98	777	101	762	100	764	98
FSDLS5FR12/CCT/LED	10W	863	89	868	92	907	95	903	94	880	91
FSDLS6FR12/CCT/LED	11W	927	85	930	88	978	91	966	91	944	88
FSDLS6FR15/CCT/LED	13W	1105	87	1113	91	1163	93	1159	93	1142	90
FSDLS8FR18/CCT/LED	18W	1712	96	1731	98	1768	101	1768	101	1760	99
FSDLS4FR10/SQ/CCT/LED	8W	694	85	712	90	729	94	730	93	720	91
FSDLS6FR12/SQ/CCT/LED	11W	1040	96	1043	98	1078	102	1089	101	1071	99
FSDLS6FR15/SQ/CCT/LED	13W	1159	93	1162	96	1198	99	1194	99	1199	96

## ProLED Select Slim Downlight Series

### Dimmer Compatibility

Dimmer Compatibility List	
Dimmer Brand	Dimmer Model
Lutron	DVCL-153PR-WH, CTCL-153PDH-WH, TGCL-153PH-WH, MACL-153MH-WH, P-PKG1W-WH-R
Leviton	R62-06674-POW, R12-06672-1LW, R50-IPL06-10M
Eaton	AAL06-C1, SAL06P-LA-K

### Dimensions

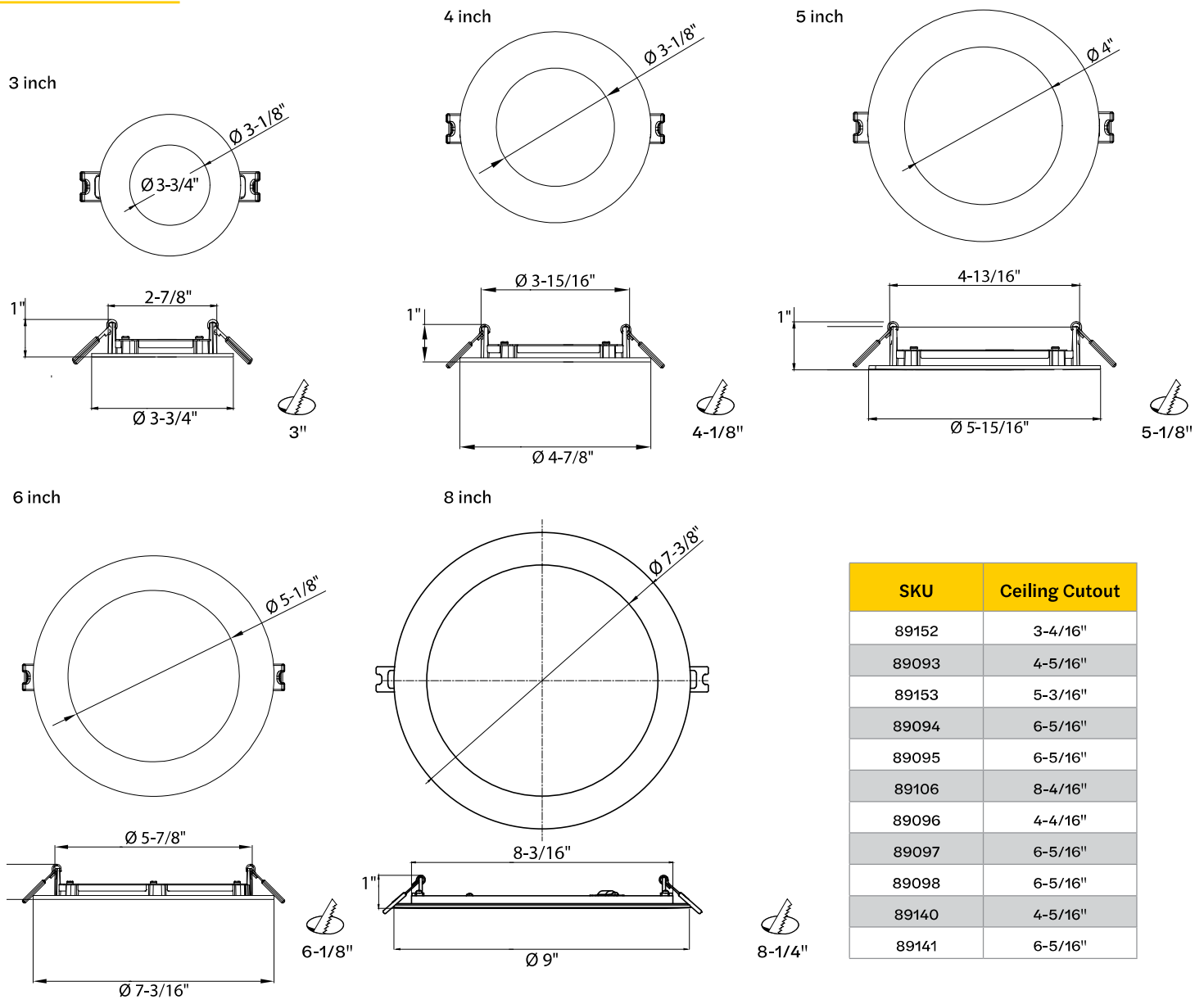

SKU	Ceiling Cutout
89152	3-4/16"
89093	4-5/16"
89153	5-3/16"
89094	6-5/16"
89095	6-5/16"
89106	8-4/16"
89096	4-4/16"
89097	6-5/16"
89098	6-5/16"
89140	4-5/16"
89141	6-5/16"

## ProLED Select Slim Downlight Series

### Photometrics

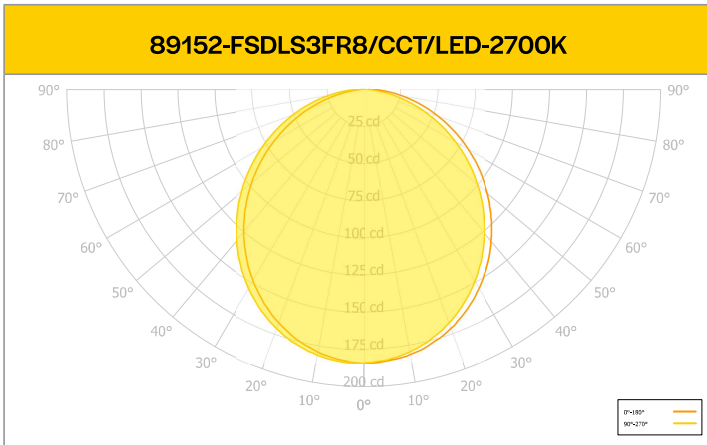

**Zonal Lumen Summary**

LCS Zone	Lumens	% Fixture
0° - 10°	17	3%
10° - 20°	50	10%
20° - 30°	74	15%
30° - 40°	88	17%
40° - 50°	90	18%
50° - 60°	80	16%
60° - 70°	60	12%
70° - 80°	35	7%
80° - 90°	10	2%
90° - 180°	0	0%
0° - 180°	504	100%

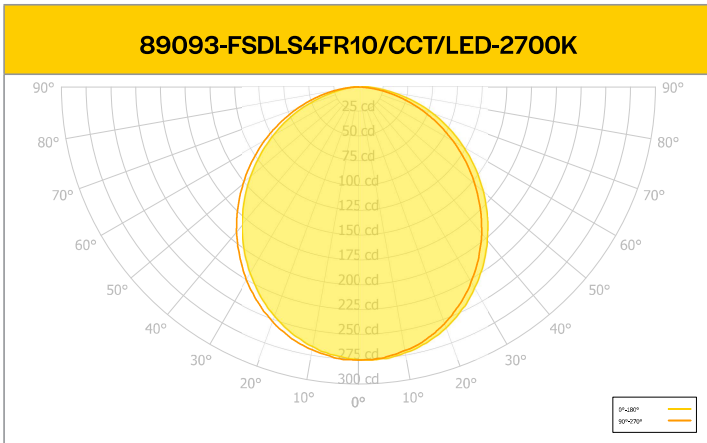

**Zonal Lumen Summary**

LCS Zone	Lumens	% Fixture
0° - 10°	26	3%
10° - 20°	74	10%
20° - 30°	111	15%
30° - 40°	131	18%
40° - 50°	134	18%
50° - 60°	118	16%
60° - 70°	89	12%
70° - 80°	50	7%
80° - 90°	14	2%
90° - 180°	1	0%
0° - 180°	749	100%

## ProLED Select Slim Downlight Series

### Photometrics

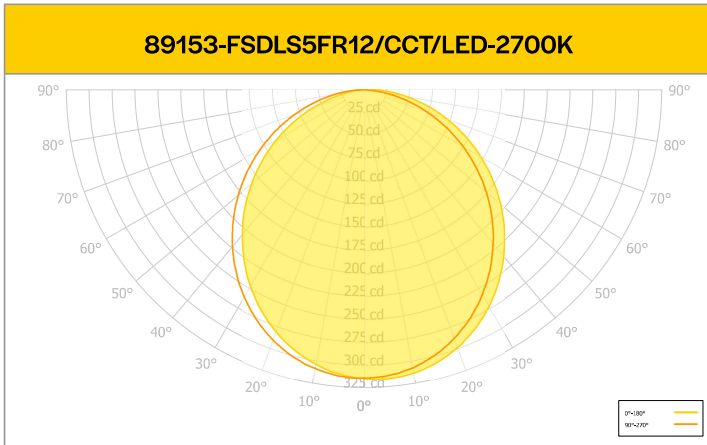

**Zonal Lumen Summary**

LCS Zone	Lumens	% Fixture
0° - 10°	30	3%
10° - 20°	85	10%
20° - 30°	127	15%
30° - 40°	151	17%
40° - 50°	154	18%
50° - 60°	137	16%
60° - 70°	103	12%
70° - 80°	59	7%
80° - 90°	17	2%
90° - 180°	1	0%
0° - 180°	863	100%

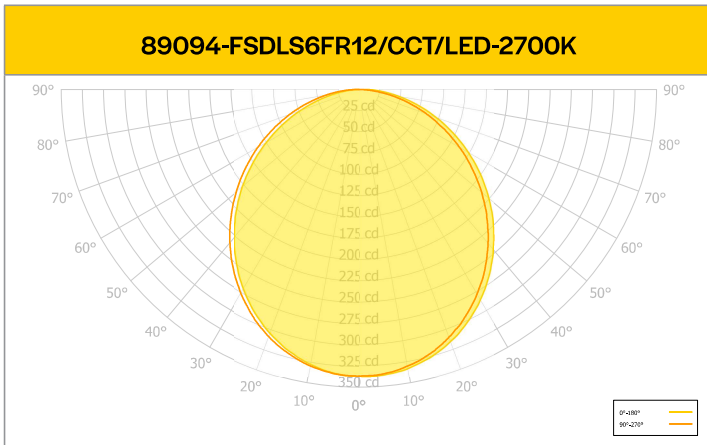

**Zonal Lumen Summary**

LCS Zone	Lumens	% Fixture
0° - 10°	32	3%
10° - 20°	91	10%
20° - 30°	136	15%
30° - 40°	161	17%
40° - 50°	164	18%
50° - 60°	146	16%
60° - 70°	110	12%
70° - 80°	65	7%
80° - 90°	20	2%
90° - 180°	1	0%
0° - 180°	927	100%

## ProLED Select Slim Downlight Series

### Photometrics

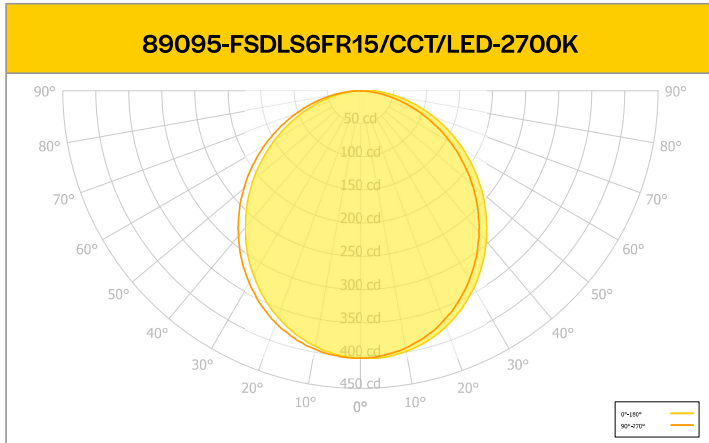

**Zonal Lumen Summary**

LCS Zone	Lumens	% Fixture
0° - 10°	38	3%
10° - 20°	109	10%
20° - 30°	163	15%
30° - 40°	193	17%
40° - 50°	197	18%
50° - 60°	174	16%
60° - 70°	131	12%
70° - 80°	76	7%
80° - 90°	23	2%
90° - 180°	1	0%
0° - 180°	1105	100%

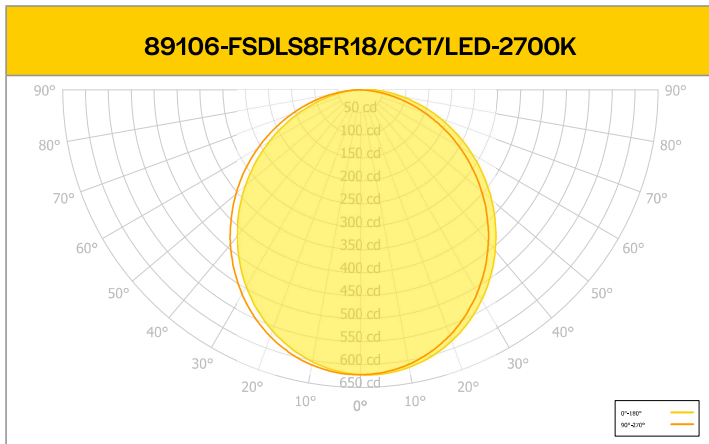

**Zonal Lumen Summary**

LCS Zone	Lumens	% Fixture
0° - 10°	59	3%
10° - 20°	167	10%
20° - 30°	251	15%
30° - 40°	299	17%
40° - 50°	305	18%
50° - 60°	271	16%
60° - 70°	205	12%
70° - 80°	120	7%
80° - 90°	35	2%
90° - 180°	1	0%
0° - 180°	1712	100%

## ProLED Select Slim Downlight Series

### Photometrics

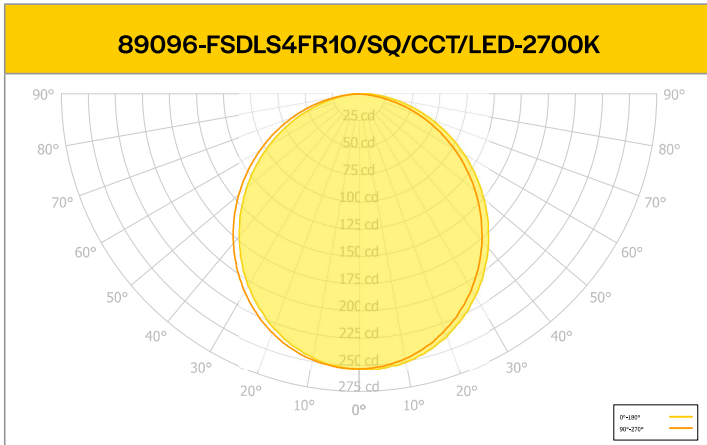

**Zonal Lumen Summary**

LCS Zone	Lumens	% Fixture
0° - 10°	24	3%
10° - 20°	68	10%
20° - 30°	103	15%
30° - 40°	122	18%
40° - 50°	124	18%
50° - 60°	110	16%
60° - 70°	83	12%
70° - 80°	47	7%
80° - 90°	12	2%
90° - 180°	1	0%
0° - 180°	694	100%

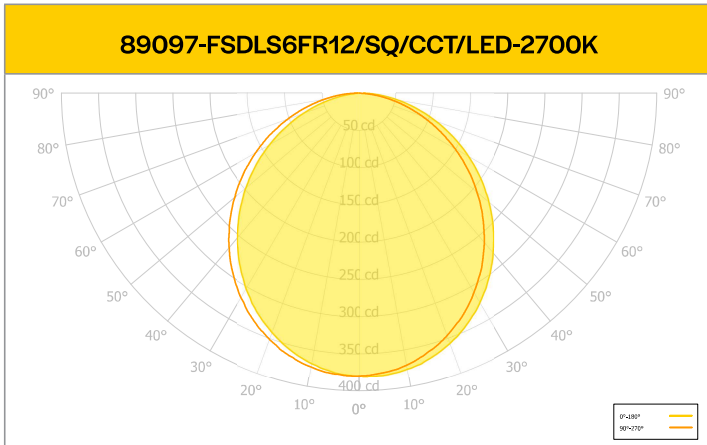

**Zonal Lumen Summary**

LCS Zone	Lumens	% Fixture
0° - 10°	36	4%
10° - 20°	102	10%
20° - 30°	153	15%
30° - 40°	182	18%
40° - 50°	185	18%
50° - 60°	164	16%
60° - 70°	123	12%
70° - 80°	71	7%
80° - 90°	21	2%
90° - 180°	1	0%
0° - 180°	1040	100%

## ProLED Select Slim Downlight Series

### Photometrics

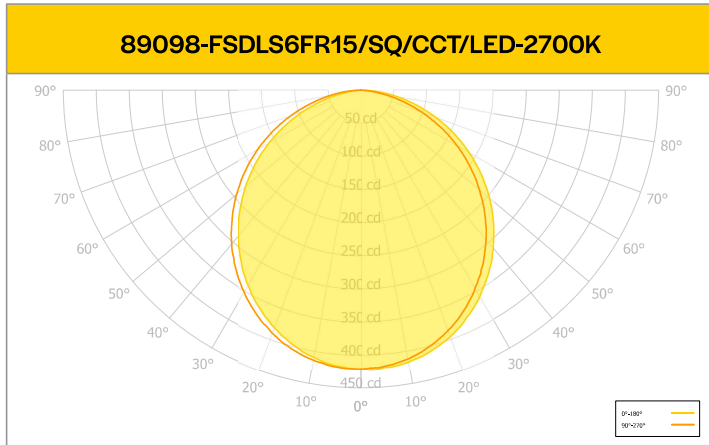

Zonal Lumen Summary		
LCS Zone	Lumens	% Fixture
0° - 10°	40	3%
10° - 20°	114	10%
20° - 30°	171	15%
30° - 40°	203	18%
40° - 50°	208	18%
50° - 60°	185	16%
60° - 70°	139	12%
70° - 80°	77	7%
80° - 90°	20	2%
90° - 180°	1	0%
0° - 180°	1159	100%