

CSL COMMERCIAL STRIP LIGHT (CCT3)

DESCRIPTION

naturaLED® CSL provides the perfect solution for your lighting needs. The LED commercial strip light maximizes energy savings and is designed for multiple applications including new construction. This fixture can be used for warehouse, parking garages, stairwells, offices, hallways and many other applications in industrial and commercial. Our commercial strip light is very versatile, efficient and is available up to 8,840 Lm, with option motion sensor.

APPLICATIONS

Warehouse, Retail, Parking Garage, Stairwell and Hallways, Storage Lighting

FEATURES

- DLC Standard
- Damp Location
- ETL Listed
- Easy installation clip-on
- Material: Steel and PC lens
- Input line voltage: 120-277V, 120-347V
- Power Factor: >0.9
- Dimmable: 0-10V
- CRI: 80
- Available in : 2', 4' or 8' length
- Selectable Color Temperature: 3CCT (3500K, 4000K, 5000K)
- Operating temperature: -13°F - 104°F
- Optional for Purchase: Motion Sensor, Emergency Drivers

PROJECT:

SCHEDULE:

DATE:

PREPARE BY:



NOTES:



*Available in
2-ft, 4-ft, & 8-ft of length

Rated Life Hours 50,000
Warranty 5 Years

ACCESSORIES

	Motion Sensor
	Emergency Drivers
	Emergency Drivers 4W

SAMPLE NUMBER FXCSL44SW/48FR/8CCT3/MV

FAMILY	SERIES	WATTAGE	SELECTABLE	LENGTH/LENS	CRI/COLOR TEMP	VOLTAGE
FX fixture	CSL commercial strip light	44 maximum wattage	SW wattage selectable	48FR 48-inch frosted	8CCT3 CRI 80 selectable color temp (3500/4000/5000K)	MV multiple voltage 347 - 347V



COMMERCIAL STRIP LIGHT (CCT3)

CEILING & AREA LUMINAIRES

ORDERING

*P= Premium DLC / *S = Standard DLC

Watts (W)	Ordering Code	Description	CCT (K)	Lumens (Lm)	Equiv. Wattage (W)	Voltage (V)	Damp Location	DLC (S/P)
22	9575	FXCSL44SW/48FR/8CCT3/MV	3CCT	2,860	3 x 32WT8	120-277V	•	S
28			(3500/	3,640				
36			4000/5000K)	4,680				
44				5,720				
44	9578	FXCSL68SW/96FR/8CCT3/MV	3CCT	5,720	5 x 32WT8	120-277V	•	S
58			(3500/	7,540				
68			4000/5000K)	8,840				
22	9577	FXCSL22/24FR/8CCT3/347	3CCT	2,860	2 x 17WT8	120-347V	•	S
			(3500/ 4000/5000K)					
22	9251	FXCSL44SW/48FR/8CCT3/347	3CCT	2,860	2 x 32WT8	120-347V	•	S
28			(3500/	3,640				
36			4000/5000K)	4,680				
44				5,720				
44	9252	FXCSL68SW/96FR/8CCT3/347	3CCT	5,720	2 x 59WT8	120-347V	•	S
58			(3500/	7,540				
68			4000/5000K)	8,840				

ACCESSORIES (Ordered Separately)



Motion Sensor
P10438 SEN-HB001VCR-1
(Motion Sensor 0-10V internal 12V)



Emergency Driver
7334 BAEM15-48BC/MV-A
(Emergency Backup Driver 120-277V
* for 4ft and 8ft CSL only)



Emergency Driver
7336 BAEM4-60BC/MV-A
(120V ~ 277V 4W EM Driver
* for 4ft and 8ft CSL only)

DIMENSIONS

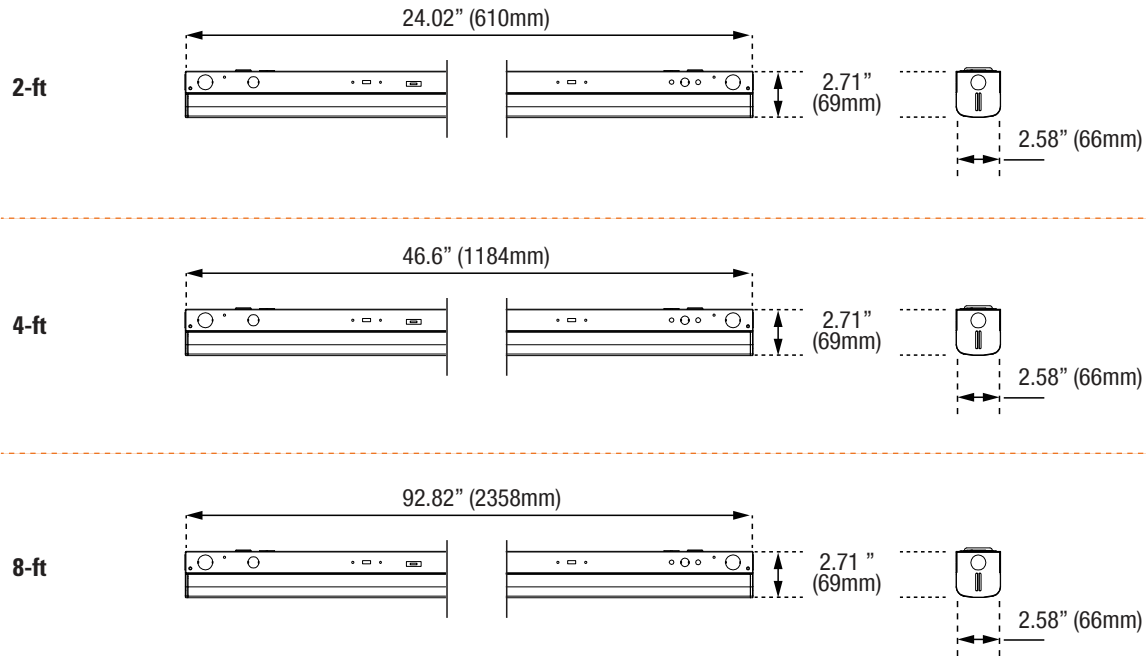

PHOTOMETRICS CHART

44 Watt - 4ft
DLC Standard

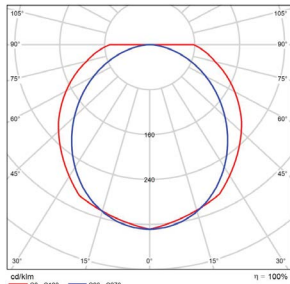

Center Beam fc	Beam Width	
593 fc	6.7 ft	4.1 ft
157 fc	12.9 ft	8.0 ft
68.6 fc	19.6 ft	12.1 ft
38.2 fc	26.2 ft	16.2 ft
24.9 fc	32.5 ft	20.1 ft
17.1 fc	39.1 ft	24.2 ft

■ Vert. Spread: 125.9°
■ Horiz. Spread: 100.9°

44 Watt - 4ft (347V)
DLC Standard

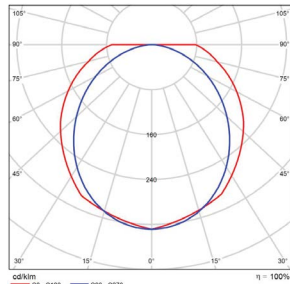

Center Beam fc	Beam Width	
593 fc	6.7 ft	4.1 ft
157 fc	12.9 ft	8.0 ft
68.6 fc	19.6 ft	12.1 ft
38.2 fc	26.2 ft	16.2 ft
24.9 fc	32.5 ft	20.1 ft
17.1 fc	39.1 ft	24.2 ft

■ Vert. Spread: 125.9°
■ Horiz. Spread: 100.9°

PACKAGE

Case Qty 8 pc
2' / 4'

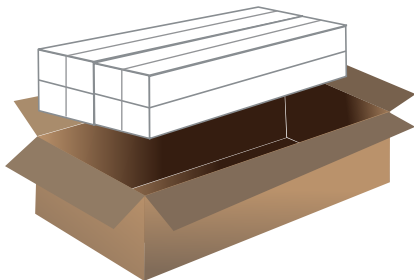

Case Qty 4 pc
8'

