



CUSTOMER NAME _____

Project Name _____

Date _____ Type _____

Catalog Number _____

The **Lumination®** LRX Series is a specifiable downlight for retrofit and new construction applications. The LRX series is available in round and square form factors with 5 aperture options ranging from 4in to 12in. The LRX series features field-selectable lumen options, adapter rings, and a variety of reflector and trim finishes, making it a versatile solution for commercial spaces.

CONSTRUCTION

Housing:	16 gauge aluminum spinning reflector housing
Lens:	Custom engineered reflectors for wide distributions.
Paint:	Powdercoat painted
Weights:	Up to 4.6 pounds
Optical Assembly:	High efficiency reflector and optical diffuser.

OPTICAL SYSTEM

Lumens:	1000–6000lm Selectable: 650/1000lm, 3000/4000lm, 4000/5000/6000lm
Distribution:	90°
Efficacy:	Up to 112 LPW
CCT:	3000K, 3500K, 4000K
CRI:	82

ELECTRICAL

Input Voltage:	120–277V
Input Frequency:	50/60Hz
Power Factor (PF)*:	> 0.9%
Total Harmonic Distortion (THD)*:	<20%

* PF and THD may vary with options

CONTROLS

Dimming:	Standard 0–10V, Dimming 10%
Controls:	Daintree compatible with accessory kit

AMBIENT TEMPERATURE

TYPE	TEMPERATURE RATE
OPERATING TEMPERATURE	-10°C TO +40°C (no EMBB) 0°C TO +25°C (with EMBB)

LUMEN MAINTENANCE

LXX(10K) @ Hours 50,000 HR
L85

MOUNTING

- Spring clips clamp on to existing frame.
- Accessible from beneath the ceiling.
- New construction utilizing FRAME.
- Fixture mounting to an existing metal frame, or install with new frame kit (ordered separately), interior ceiling applications only.
- Conduit connect to quick-disconnect for easy installation.

ADDITIONAL NOTES

- Non-IC Rated
- IK00 Impact Resistant
- Optional black, white or silver trims available (ordered separately)

DESIGN LIFE & WARRANTY

- **Current's Limited 5-year Warranty:**
Please see website.



LRX
8
MD

FAMILY	SHAPE/SIZE	LUMENS	CRI	CCT	DIMMING	OPTIONS
LRX = Lumination® LRX Series Downlight	R4 = 4" Round Retrofit Downlight S4 = 4" Square Retrofit Downlight	10¹ = 1000lm/650lm	8 = 82 CRI	30 = 3000K 35 = 3500K 40 = 4000K	MD = 0–10V Dimming	Blank = None EL = EMBB Ready
	R6 = 6" Round Retrofit Downlight S6 = 6" Square	10¹ = 1000lm/650lm 18 = 1800lm				
	R8 = 8" Round Retrofit Downlight S8 = 8" Square Retrofit Downlight	10¹ = 1000lm/650lm 18 = 1800lm 30 = 3000lm 40¹ = 4000lm/3000lm				
	R10⁴ = 10" Round Retrofit Downlight	30⁴ = 3000lm 60^{1,4} = 4000lm/5000lm/6000lm				
	R12⁴ = 12" Round Retrofit Downlight	60^{1,4} = 4000lm/5000lm/6000lm				

Notes:

- Selectable Lumen packages allow for field adjustments to light output. See page 7 for details.
- The standard trim is white. Colored trim options are available see page 4 for details.
- Attach to existing frame or install with new frame kit (ordered separately) per UL.
- 10inch and 12inch 3000lm & 4000/5000/6000lm only for MD=0–10V dimming.

0–10V DIMMING							
NOMINAL LUMENS	650	1000	1800	3000	4000	5000	6000
Delivered Lumens - LRX*4	700	1020	N/A	N/A	N/A	N/A	N/A
Delivered Lumens - LRX*6	700	1050	1900	N/A	N/A	N/A	N/A
Delivered Lumens - LRX*8	750	1200	2000	3300	N/A	N/A	N/A
Delivered Lumens - LRXR10	N/A	N/A	N/A	3180	4600	5400	6200
Delivered Lumens - LRXR12	N/A	N/A	N/A	N/A	4650	5450	6250
System Input Power (W)	8.5	13	22	35	41	49	59.5
System Efficacy (LPW)	88	92	91	94	112	110	104

DELIVERED LUMEN MULTIPLIERS	
CCT	MULTIPLIERS
4000K	1
3500K	0.98
3000K	0.94

ACCESSORIES: LUMINATION® LRX SERIES - REMODEL (GOOF) RINGS

The essential accessory for any project, the goof ring helps to cover openings in the ceiling with a trim that blends with the existing LRX trim. Goof rings are available in white only. Verify the existing opening and LRX fixture to order the correct goof ring, details shown in the table below. Always verify proper installation per the Installation Guide.

Installation Position

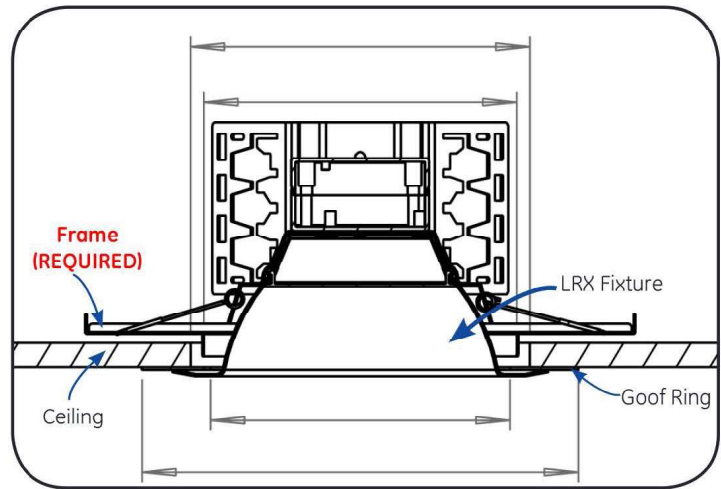
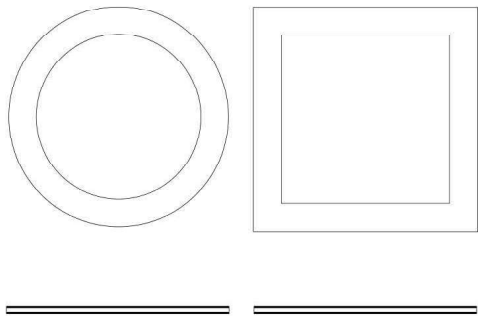

Notes: Please check the compatibility of the goof ring and the fixture by referring to the table below.









Goof Rings

FOR NEW CONSTRUCTION									FOR RETROFIT	
GOOF RING SKU	GOOF RING DESCRIPTION	GOOF RING SHAPE	SUITABLE FIXTURE	SUITABLE FRAME	INSIDE OF GOOF RING (IN)	OUTSIDE OF GOOF RING (IN)	CEILING HOLD MIN. (IN)	CEILING HOLE MAX. (IN)	SUITABLE FRAME DIMENSION (IN)	FRAME HOLE (IN)
93114516	GRRX4R6PTWT	ROUND	LRXR4XXXXXX	FRAME4RXXXX	4.48	7.09	5.20	6.69	12.60 x 7.64 x 3.54	4.20–4.70
93114517	GRRX4S6PTWT	SQUARE	LRXS4XXXXXX	FRAME4SXXXX	4.48	7.09	5.20	6.19	12.60 x 7.64 x 3.54	4.20–4.90
93114518	GRRX6R8PTWT	ROUND	LRXR6XXXXXX	FRAME6RXXXX	6.18	9.00	6.50	8.60	12.60 x 7.64 x 3.54	5.91–6.50
93114519	GRRX6S8PTWT	SQUARE	LRXS6XXXXXX	FRAME6SXXXX	6.22	8.98	7.50	8.08	13.35 x 11.34 x 3.54	5.95–7.50
93114520	GRRX8R10PTWT	ROUND	LRXR8XXXXXX	FRAME8RXXXX	7.87	10.50	8.27	10.10	15.55 x 11.34 x 3.54	7.68–8.27
93114521	GRRX8S10PTWT	SQUARE	LRXS8XXXXXX	FRAME8SXXXX	8.23	10.98	9.50	10.08	13.35 x 11.34 x 3.54	7.95–9.50
93114522	GRRX8R12PTWT	ROUND	LRXR8XXXXXX	FRAME8RXXXX	7.87	12.99	10.10	12.59	15.55 x 11.34 x 3.54	7.68–8.27
93114523	GRRX8S12PTWT	SQUARE	LRXS8XXXXXX	FRAME8SXXXX	8.23	12.99	10.58	12.09	13.35 x 11.34 x 3.54	7.95–9.50

ACCESSORIES: LUMINATION® LRX SERIES

PRODUCT DESCRIPTION	MATERIAL DESCRIPTION	MATERIAL	NOTES
EMERGENCY BATTERY BACKUP KIT (7W)	LRXEMBBKIT07	93043031	7 WATT EMBB QUICK CONNECT KIT (MUST HAVE FIXTURE WITH "EL" OPTION)
EMERGENCY BATTERY BACKUP KIT (10W)	LRXEMBBKIT10	93043540	10 WATT EMBB QUICK CONNECT KIT (MUST HAVE FIXTURE WITH "EL" OPTION)
4" NEW CONSTRUCTION ROUND FRAME KIT	FRAME4R	93090208	RECOMMENDED FOR NEW CONSTRUCTION APPLICATIONS
6" NEW CONSTRUCTION ROUND FRAME KIT	FRAME6R	93025091	RECOMMENDED FOR NEW CONSTRUCTION APPLICATIONS
8" NEW CONSTRUCTION ROUND FRAME KIT	FRAME8R	93025092	RECOMMENDED FOR NEW CONSTRUCTION APPLICATIONS
10" NEW CONSTRUCTION ROUND FRAME KIT	FRAME10R	93124880	RECOMMENDED FOR NEW CONSTRUCTION APPLICATIONS
12" NEW CONSTRUCTION ROUND FRAME KIT	FRAME12R	93124881	RECOMMENDED FOR NEW CONSTRUCTION APPLICATIONS
4" NEW CONSTRUCTION SQUARE FRAME KIT	FRAME4S	93090209	RECOMMENDED FOR NEW CONSTRUCTION APPLICATIONS
6" NEW CONSTRUCTION SQUARE FRAME KIT	FRAME6S	93045426	RECOMMENDED FOR NEW CONSTRUCTION APPLICATIONS
8" NEW CONSTRUCTION SQUARE FRAME KIT	FRAME8S	93045427	RECOMMENDED FOR NEW CONSTRUCTION APPLICATIONS
347V KIT	LRX347V277	93036250	347V TRANSFORMER QUICK CONNECT KIT
DAINTREE CONTROLS ACCESSORY KIT	LCABAVTQUNGALV	93057194	SEE LCA KIT LITERATURE & INSTALL GUIDE, DOES NOT INCLUDE SENSOR
SENSOR ACCESSORY KIT - DAINTREE ENTERPRISE	LSAATZFM6	93098473	SEE LSA KITS LITERATURE & INSTALL GUIDE
SENSOR ACCESSORY KIT - DAINTREE ONE & EZ CONNECT	LSAAT/T1FM6	93098472	SEE LSA KITS LITERATURE & INSTALL GUIDE
HANGER BAR, C-CHANNEL, 25-1/4" (BOXED PAIR)	BH3	93110306	RECOMMENDED FOR NEW CONSTRUCTION APPLICATIONS

ACCESSORIES: LUMINATION® LRX SERIES COLORED ROUND TRIM OPTIONS

	ROUND					SQUARE			
	SILVER	BLACK	SPECULAR WITH WHITE TRIM	SEMI-DIFFUSE WITH WHITE TRIM	SEMI-DIFFUSE WITH MATCHING TRIM	SILVER	BLACK	SPECULAR WITH WHITE TRIM	SEMI-DIFFUSE WITH WHITE TRIM
									
4"	93151744 LRXTRIMR4SV	93151745 LRXTRIMR4BL	93151746 LRXTRIMR4SP	93151747 LRXTRIMR4SD		93151748 LRXTRIMS4SV	93151749 LRXTRIMS4BL	93151750 LRXTRIMS4SP	93151751 LRXTRIMS4SD
6"	93059502 LRXTRIMR6SV	93059501 LRXTRIMR6BL	93151752 LRXTRIMR6SP	93151753 LRXTRIMR6SD	93152569 LRXTRIMR6SA	93151754 LRXTRIMS6SV	93151755 LRXTRIMS6BL	93151756 LRXTRIMS6SP	93151757 LRXTRIMS6SD
8"	93059504 LRXTRIMR8SV	93059503 LRXTRIMR8BL							

DIMENSIONS

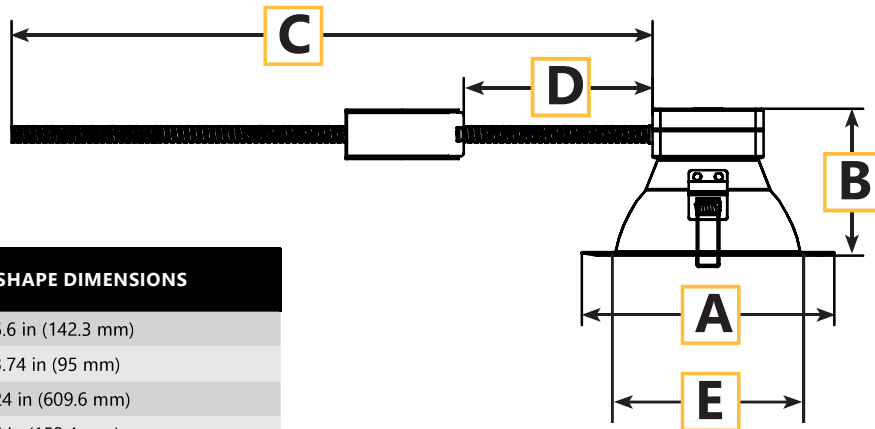
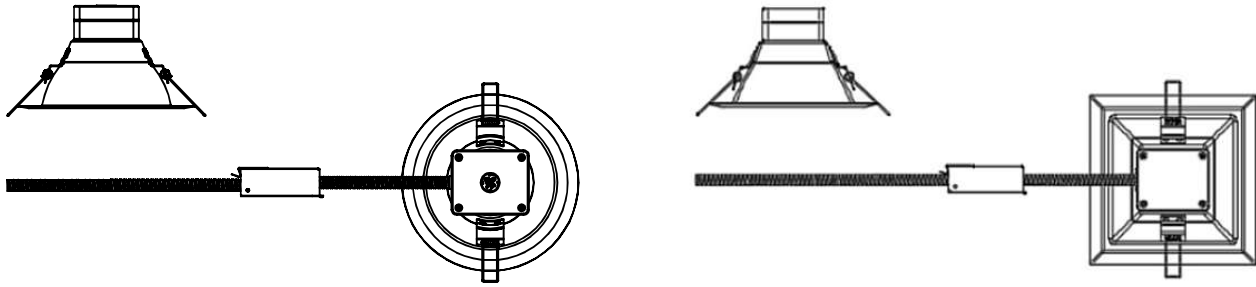

ROUND SHAPE DIMENSIONS

Size	A	B	C	D	E
4 in	5.6 in (142.3 mm)	3.74 in (95 mm)	24 in (609.6 mm)	6 in (152.4 mm)	Ceiling Cutout Min: 4.4 in
	7.75 in (196.8 mm)	4.5 in (114.2 mm)	24 in (609.6 mm)	6 in (152.4 mm)	Ceiling Cutout Min: 5.7 in
	9.75 in (247.6 mm)	5.1 in (129.4 mm)	24 in (609.6 mm)	6 in (152.4 mm)	Ceiling Cutout Min: 7.7 in
	12 in (305 mm)	5.8 in (148.2 mm)	24.0 in (609.6 mm)	6 in (152.4 mm)	Ceiling Cutout Min: 9.7 in
	14 in (355 mm)	6.23 in (158.2 mm)	24 in (609.6 mm)	6 in (152.4 mm)	Ceiling Cutout Min: 11.7 in

SQUARE SHAPE DIMENSIONS

Size	A	B	C	D	E
4 in	5.75 in (146 mm)	3.74 in (95 mm)	24 in (609.6 mm)	6 in (152.4 mm)	Ceiling Cutout Min: 4 in for ceiling thickness ≤ 10 mm; 4.2 in for ceiling thickness > 10 mm
	7.75 in (196.8 mm)	4.5 in (114.2 mm)	24 in (609.6 mm)	6 in (152.4 mm)	Ceiling Cutout Min: 5.6 in
	9.75 in (247.6 mm)	5.1 in (129.4 mm)	24 in (609.6 mm)	6 in (152.4 mm)	Ceiling Cutout Min: 7.6 in
	12 in (305 mm)	5.8 in (148.2 mm)	24 in (609.6 mm)	6 in (152.4 mm)	
	14 in (355 mm)	6.23 in (158.2 mm)	24 in (609.6 mm)	6 in (152.4 mm)	

PHOTOMETRIC DATA:

4" Round LRX
1059 LM
LRXR410830MD

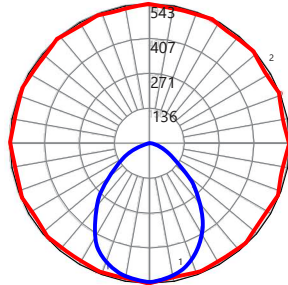

ZONE	LUMENS
0-10	50.98
10-20	143.53
20-30	208.85
30-40	226.68
40-50	194.68
50-60	131.45
60-70	66.78
70-80	29.04
80-90	6.9

ZONE	LUMENS	% OF FIXTURE
0-20	194.51	18.4
0-30	403.36	38.1
0-40	630.04	59.5
0-60	956.17	90.3
0-80	1052.0	99.3
0-90	1058.9	100.0

6" Round LRX
1000 LM
LRXR610830MD

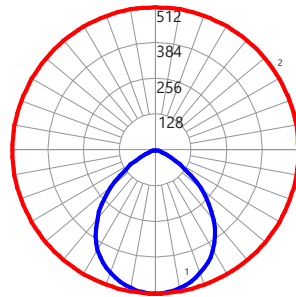

ZONE	LUMENS
0-10	48.26
10-20	135.99
20-30	199.14
30-40	221.96
40-50	188.12
50-60	118.95
60-70	54.04
70-80	25.47
80-90	7.78

ZONE	LUMENS	% OF FIXTURE
0-20	184.25	18.4
0-30	383.39	38.3
0-40	605.34	60.5
0-60	912.41	91.2
0-80	991.92	99.2
0-90	999.70	100.0

8" Round LRX
1797 LM
LRXR818830MD

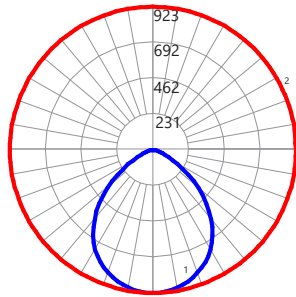

ZONE	LUMENS
0-10	87.00
10-20	245.00
20-30	357.94
30-40	405.72
40-50	355.72
50-60	213.19
60-70	84.35
70-80	37.58
80-90	10.61

ZONE	LUMENS	% OF FIXTURE
0-20	332.00	18.4
0-30	689.94	38.3
0-40	1095.66	60.9
0-60	1664.57	92.5
0-80	1786.51	99.2
0-90	1797.12	99.8

10" Round LRX
5893 LM
LRXR1030830MD

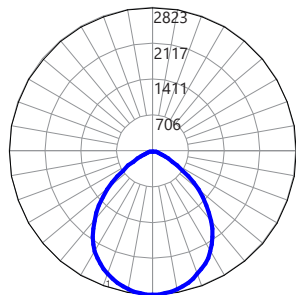

ZONE	LUMENS
0-10	265.56
10-20	751.07
20-30	1109.15
30-40	1284.03
40-50	1192.46
50-60	797.55
60-70	323.82
70-80	129.46
80-90	639.60

ZONE	LUMENS	% OF FIXTURE
0-20	538.49	17.2
0-30	2125.78	36.0
0-40	3409.81	57.8
0-60	5399.82	91.5
0-80	5853.11	99.2
0-90	5892.71	99.9
10-90	5627.15	95.4
20-40	2393.19	40.6
20-50	3585.65	60.8
40-70	2313.83	39.2
60-80	453.28	7.7
70-80	129.46	2.2
80-90	39.60	0.7

PHOTOMETRIC DATA:

12" Round LRX
6070 LM
LRXR1260830MD

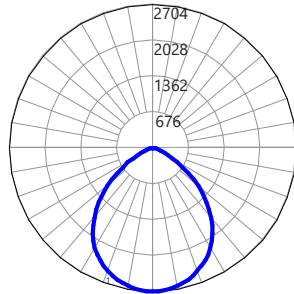

ZONE	LUMENS
0-10	254.76
10-20	726.52
20-30	1087.30
30-40	1279.70
40-50	1270.85
50-60	939.08
60-70	372.27
70-80	106.14
80-90	33.16

ZONE	LUMENS	% OF FIXTURE
0-20	981.28	16.1
0-30	2068.58	34.0
0-40	3348.28	55.1
0-60	5558.22	91.5
0-80	6036.63	99.3
0-90	6069.79	99.9
10-90	5815.03	95.7
20-40	2367.00	39.0
20-50	3637.86	59.9
40-70	2582.21	42.5
60-80	478.41	7.9
70-80	106.14	1.7
80-90	33.16	0.5

4" Square LRX
1045 LM
LRXS410830MD

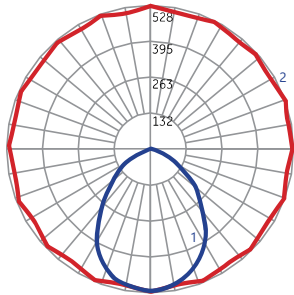

ZONE	LUMENS
0-10	48.79
10-20	136.05
20-30	195.03
30-40	214.18
40-50	192.29
50-60	143.00
60-70	81.10
70-80	27.89
80-90	6.20

ZONE	LUMENS	% OF FIXTURE
0-20	184.85	17.7
0-30	379.88	36.3
0-40	594.06	56.7
0-60	929.35	88.8
0-80	1038.34	99.2
0-90	1044.54	99.8

6" Square LRX
1050 LM
LRXS610830MD

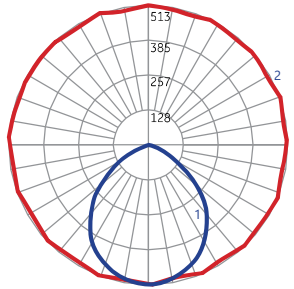

ZONE	LUMENS
0-10	48.40
10-20	137.38
20-30	203.26
30-40	229.80
40-50	202.64
50-60	136.51
60-70	63.03
70-80	22.61
80-90	6.12

ZONE	LUMENS	% OF FIXTURE
0-20	185.78	17.7
0-30	389.04	37.1
0-40	618.84	58.9
0-60	957.99	91.2
0-80	1043.63	99.4
0-90	1049.74	100.0

8" Square LRX
1199 LM
LRXS810830MD

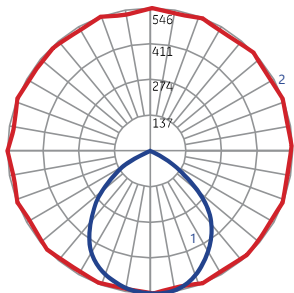

ZONE	LUMENS
0-10	51.81
10-20	147.65
20-30	220.84
30-40	258.58
40-50	243.12
50-60	169.22
60-70	75.23
70-80	25.23
80-90	7.77

ZONE	LUMENS	% OF FIXTURE
0-20	199.46	16.6
0-30	420.3	35.0
0-40	678.88	56.6
0-60	1091.68	90.9
0-80	1191.68	99.3
0-90	1199.45	100.0

DAINTREE CONTROLS

Daintree® Wireless Controls:

There is no one size fits all for wireless controls. Some networks want simple solutions that reduce energy consumption and meet code compliance while others are more ambitious, looking to capitalize on the LED and controls savings to fund a scalable, enterprise-grade, internet of things solution. The advantage of the Daintree® Wireless platform is its ability to integrate into indoor, outdoor and high bay environments. The Daintree® Wireless Controls provide the infrastructure to future proof your buildings, easily upgrade to Networked solutions and provide the ability to integrate into IoT solutions that are right for your business.

- **Daintree® One:** Standalone Wireless Controls
- **Daintree® EZ Connect:** Room-Based Wireless Lighting Controls
- **Daintree® Networked:** Networked Lighting Controls for Smart Building & IoT Enablement.

Daintree® Wireless Controls are already integrated in your favorite Current LED fixtures. Integrating the controls into the fixture cuts labor costs considerably since the sensors are already embedded in the lighting fixtures. There's no need to get above the ceiling plenum and install additional devices. Visit our website LED.com for a complete list of LED Fixtures.