

Hi-lume 3D Overview

Hi-lume 3D architectural electronic dimming ballasts are designed to meet the most demanding lighting requirements. By providing industry leading performance with a full-range of 100% to less than 1% fluorescent dimming, Hi-lume 3D ballasts enable you to provide the ideal visual environment for any application.

Features

- Continuous, flicker-free dimming from 100% to 0.7% for T8, 1% for T5 and T5HO, and 5% for T5 twin-tube.
- 100% compatible with all Lutron 3-wire fluorescent controls and EcoSystem digital controls for consistent fixture-to-fixture dimming performance.
- Compatible with Energi Savr Node with EcoSystem devices, GRAFIK Eye QS control unit, PowPak dimming module with EcoSystem connection, and Quantum software, allowing for integration into an existing or planned EcoSystem lighting control solution.
- Programmed rapid-start design preheats lamp cathodes before applying full arc voltage to ensure full-rated lamp life while dimming and cycling.
- Lamps turn on to any dimmed level without going to full brightness.
- Low harmonic distortion throughout the entire dimming range maintains power quality.
- Frequency of operation ensures that ballast does not interfere with infrared devices operating between 38 kHz and 42 kHz.
- Inrush current limiting circuitry eliminates circuit breaker tripping, switch arcing, and relay failure.
- Ballasts maintain consistent light output for different lamp lengths, ensuring fixture-to-fixture uniformity.
- Ultra-quiet operation.
- Ballast protected from miswires of any input power to control lead, or from lamp leads to each other and/or ground.



Hi-lume 3D, case type C
 1.18 in (30 mm) W x 1.00 in (25 mm) H x 18.00 in (457 mm) L



Hi-lume 3D, case type G
 2.38 in (60 mm) W x 1.00 in (25 mm) H x 9.50 in (241 mm) L

- 100% performance-tested and burned-in at factory.
- Non-volatile memory restores all ballast settings after power failure.
- Buy American Act (BAA) models available; see Model List for specific availability.
- RoHS compliant.
- NOM certified models available; see Model List for specific availability.
- Custom ballast factors available for UL® or CSA-listed products. Design tool and specifications can be found at www.lutron.com/ballasttool.

<p>Job Name:</p> <p>Job Number:</p>	<p>Model Numbers:</p>
--	------------------------------

Specifications

Regulatory Approvals

- UL® Listed (evaluated to the requirements of UL935)
- CSA certified (evaluated to the requirements of C22.2 No. 74) (specific model numbers only)
- Class P thermally protected
- Meets ANSI C82.11 High Frequency Ballast Standard
- Meets FCC Part 18 Non-Consumer requirements for EMI/RFI emissions
- Meets ANSI C62.41 Category A surge protection standards up to and including 4 kV
- Manufacturing facilities employ ESD reduction practices that comply with the requirements of ANSI/ESD S20.20
- Lutron Quality Systems registered to ISO9001.2008
- Some models are affected by California Title 20. California customers may need to order alternative models to comply. See California Customer section on page 4 of this document for details. Also see Lutron Application Note #601, **CEC Title 20 Regulation**, at www.lutron.com/title20ballasts for more information
- This device complies with Part 18 (Non-Consumer Limits) of the FCC Rules. Operation is subject to the following conditions:
 - (1) This device may cause interference to radio equipment.
 - (2) This device should not be installed near maritime safety communications equipment or other critical navigation or communication equipment operating between 0.45–30 MHz.

Modification not expressly approved by Lutron Electronics Co., Inc. could void the users authority to operate this equipment.

This Non-Consumer RFLD complies with the Canadian standard ICES-005.

Environment

- Minimum lamp starting temperature: 50 °F (10 °C)
- Relative humidity: ≤ 90% non-condensing
- Sound Rating: Class A
- Maximum ballast case temperature: 75 °C

Ballast Wiring and Mounting

- Ballast is grounded via a mounting screw to the fixture
- Ballast mounts using two screws (or sheet metal feature and one screw) within a fluorescent fixture.
- Power and lamp wiring terminals accept one 18 AWG to 16 AWG (0.75 mm² to 1.5 mm²) solid copper wire per terminal.

Lamp Seasoning

- Refer to the lamp manufacturer's requirements for lamp seasoning requirements prior to dimming.

Warranty

- 5-year limited warranty with Lutron field service commissioning (3-year standard warranty) from date of purchase. For additional Warranty information, please visit: www.lutron.com/ballastwarranty

Job Name: Job Number:	Model Numbers:
--	-----------------------

Specifications *(continued)*

Performance

- Dimming Range: 100% to 0.7% measured relative light output (RLO) for T8, 100% to 1% measured RLO for T5 and T5HO, and 100% to 5% measured RLO for T5 twin-tube.
- Lamp Starting: programmed rapid-start
- Lamp Current Crest Factor: ≤ 1.7
- Lamp Flicker: none visible
- Light Output Variation: constant $\pm 2\%$ light output for line voltage variations of $\pm 10\%$
- Lamp Life: average lamp life meets or exceeds rating of lamp manufacturer
- Power Factor: ≥ 0.95
- Typical Total Harmonic Distortion (THD) $\leq 10\%^*$
- Maximum Inrush Current: 7 A per ballast at 120 V~, 3 A per ballast at 277 V~
- Operating Voltage: Universal input 120, 220/240, 277 V~ at 50/60 Hz
- Frequency of Operation: ≥ 42 KHz
- Ballast Factor (BF): 1.0/1.17 for T8 lamps and 1.0 for T5, T5HO, and T5 twin-tube lamps

Dimming Range for T5 and T5HO lamps:

BF	Dimming Range (Max/Min [BF])	Dimming Ratio
1.0	1.00 / 0.01	100:1

Dimming Range for T8 lamps:

BF	Dimming Range (Max/Min [BF])	Dimming Ratio
1.17	1.17 / 0.0085	138:1
1.0	1.00 / 0.0085	118:1

Dimming Range for T5 Twin Tube lamps:

BF	Dimming Range (Max/Min [BF])	Dimming Ratio
1.0	1.00 / 0.05	100:5

* Typical THD for models H3DT817CU110, H3DT514CU110 and H3DT521CU110 less than 15%.

Job Name:	Model Numbers:
Job Number:	

Hi-lume 3D Ballasts for Linear and U-Bent T8 Lamps

For proper dimming, all lamps must comply with accepted standards: 17, 25, 32, 40 W (NEMA LL9-2009)

Not for use with reduced-wattage lamps.

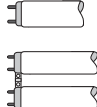
Lamp Type	Lamp Watts (length)	Lamps per Ballast	Case Size	Hi-lume 3D Model Number	Input Voltage (V~)	Ballast Current (A)	Ballast Factor (BF)	Input Power (W)	System Lumens ³ (lm)	System Efficacy ³ (lm/W)	Ballast Efficacy Factor (BEF)	Relative System Efficacy (RSE)
	40 W (60 in [1524 mm])	1	C	H3D T840 C U 1 10	120 240 277	0.38 0.18 0.16	1.00 1.00 1.00	43.8 43.0 42.8	3800 3800 3800	87 88 89	2.28 2.33 2.34	0.91 0.93 0.94
		1	C	H3D T840 C U 1 17	120 240 277	0.42 0.21 0.18	1.17 1.17 1.17	50.6 49.4 49.6	4446 4446 4446	88 90 90	2.31 2.37 2.36	0.92 0.95 0.92
		2	C	H3D T840 C U 2 10	120 240 277	0.76 0.37 0.32	1.00 1.00 1.00	90.9 88.4 88.9	7600 7600 7600	84 86 86	1.10 1.13 1.13	0.90 0.91 0.94
		2	C	H3D T840 C U 2 17	120 240 277	0.85 0.41 0.36	1.17 1.17 1.17	100.3 97.2 98.2	8892 8892 8892	89 92 91	1.17 1.20 1.19	0.93 0.96 0.95
	32 W (48 in [1219 mm])	1	C	H3D T832 C U 1 10 ^{1,2}	120 240 277	0.32 0.16 0.14	1.00 1.00 1.00	38.5 37.7 37.6	3000 3000 3000	78 80 80	2.60 2.65 2.66	0.83 0.85 0.85
			G	H3D T832 G U 1 10 ^{1,2,4}	120 240 277	0.30 0.15 0.13	1.00 1.00 1.00	34.8 35.0 35.1	3000 3000 3000	86 86 85	2.87 2.85 2.85	0.92 0.91 0.91
		1	C	H3D T832 C U 1 17 ^{1,2}	120 240 277	0.34 0.17 0.15	1.17 1.17 1.17	40.8 40.8 41.6	3510 3510 3510	86 86 84	2.87 2.87 2.82	0.92 0.92 0.90
			G	H3D T832 G U 1 17 ^{1,4}	120 240 277	0.34 0.17 0.15	1.17 1.17 1.17	39.7 40.0 40.1	3510 3510 3510	88 88 88	2.95 2.92 2.92	0.94 0.94 0.93
		2	C	H3D T832 C U 2 10 ^{1,2}	120 240 277	0.57 0.28 0.24	1.00 1.00 1.00	68.4 67.2 66.5	6000 6000 6000	88 89 90	1.46 1.49 1.50	0.94 0.95 0.96
			G	H3D T832 G U 2 10 ^{1,2,4}	120 240 277	0.58 0.28 0.24	1.00 1.00 1.00	68.9 66.3 66.5	6000 6000 6000	91 90 90	1.52 1.51 1.50	0.97 0.97 0.96
		2	C	H3D T832 C U 2 17 ^{1,2}	120 240 277	0.65 0.32 0.28	1.17 1.17 1.17	78.0 76.8 77.6	7020 7020 7020	90 91 91	1.50 1.52 1.51	0.96 0.98 0.97
			G	H3D T832 G U 2 17 ^{1,4}	120 240 277	0.67 0.31 0.28	1.17 1.17 1.17	75.4 76.5 76.9	7020 7020 7020	93 92 91	1.55 1.53 1.52	0.99 0.98 0.97
		3	G	H3D T832 G U 3 10 ^{1,2,4}	120 240 277	0.83 0.40 0.37	1.00 1.00 1.00	99.6 96.0 102.5	9000 9000 9000	90 94 88	1.00 1.04 0.98	0.96 1.00 0.94
		3	G	H3D T832 G U 3 17 ^{1,4}	120 240 277	0.95 0.47 0.41	1.17 1.17 1.17	114.0 112.8 113.6	10,530 10,530 10,530	92 93 93	1.03 1.04 1.03	0.99 1.00 0.99

(Continued on next page)

Notes

- ¹ BAA models available. Add a "U" to prefix of model number when ordering (e.g., **UH3D T832 C U 1 10**).
- ² NOM approved models available. Add an "N" to suffix of model number when ordering (e.g., **H3D T832 C U 1 10N**).
- ³ Actual number may vary with lamp model. Please consult lamp manufacturer for lamp-specific data.
- ⁴ Not for sale in California - see Lutron Application Note #601, **CEC Title 20 Regulation**, for information on alternative models.

Job Name:	Model Numbers:
Job Number:	

Hi-lume 1% Ballasts for Linear and U-Bent T8 Lamps (California customers only)

For proper dimming, all lamps must comply with accepted standards: 17, 25, 32, 40 W (NEMA LL9-2009)

Not for use with reduced-wattage lamps.

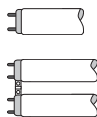
Lamp Type	Lamp Watts (length)	Lamps per Ballast	Case Size	Hi-lume 3D Model Number	Input Voltage (V~)	Ballast Current (A)	Ballast Factor (BF)	Input Power (W)	System Lumens ¹ (lm)	System Efficacy ¹ (lm/W)	Ballast Efficacy Factor (BEF)	Relative System Efficacy (RSE)
T8 and U-Bent 	32 W (48 in [1219 mm])	3	G	H3 T832 G U 3 10 ²	120	0.83	1.00	99.6	9000	90	1.00	0.96
					240	0.40	1.00	96.0	9000	94	1.04	1.00
					277	0.37	1.00	102.5	9000	88	0.98	0.94
		3	G	H3 T832 G U 3 17 ²	120	0.95	1.17	114.0	10,530	92	1.03	0.99
					240	0.47	1.17	112.8	10,530	93	1.04	1.00
					277	0.41	1.17	113.6	10,530	93	1.03	0.99
3	G	H3 T832 G U 3 C85 ²	120	0.75	0.85	90.0	7650	85	0.94	0.91		
			240	0.37	0.85	88.8	7650	86	0.96	0.92		
			277	0.32	0.85	88.6	7650	86	0.96	0.92		

Notes

- ¹ Actual number may vary with lamp model. Please consult lamp manufacturer for lamp-specific data.
- ² California models are only available with a 3-wire control. For an EcoSystem control, use with a C5-BMF-2A.

Job Name:	Model Numbers:
Job Number:	

Case Dimensions

C

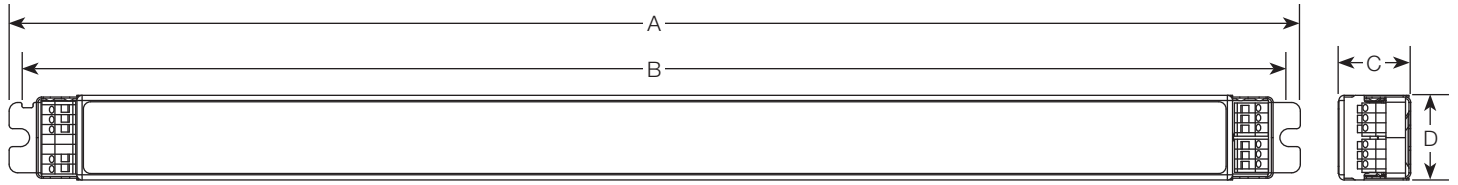

- A 18.0 in (457 mm)
- B 17.68 in (449 mm) (mounting center)
- C 1.0 in (25 mm)
- D 1.18 in (30 mm)

G

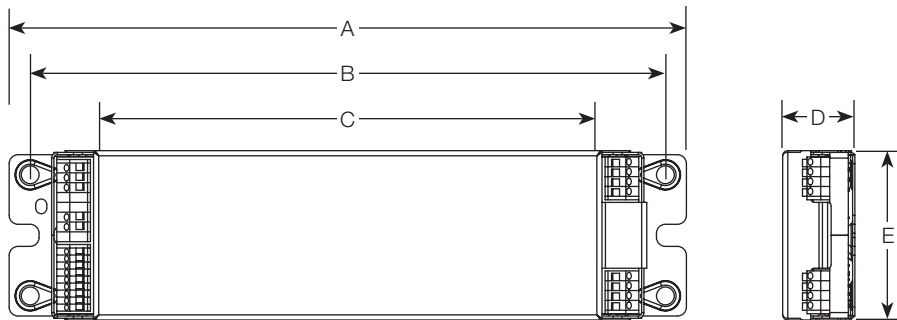

- A 9.5 in (241 mm)
- B 8.9 in (226 mm) (mounting centers)
- C 7.1 in (180 mm)
- D 1.0 in (25 mm)
- E 2.38 in (60 mm)

Job Name:	Model Numbers:
Job Number:	

Hi-lume 3D Dimmer Wiring

3-Wire Control Wiring



WARNING: Shock hazard. May result in serious injury or death. Disconnect power before servicing or installing.

- Make sure that the supply breaker to the Digital Ballast is OFF when wiring
- Wire as shown

Line input	Connects to
Hot	Dimmer Black Wire
Neutral	Dimmer White Wire

Dimmer wire	Connects to
Yellow	Ballast Orange (DH)
Red	Ballast Black (HOT)
White	Ballast White (NEU)
Green	Earth Ground

- Hi-lume 3D ballast line voltage and 3-wire input terminals accept one 18 AWG to 16 AWG (0.75 mm² to 1.5 mm²) solid copper wire per terminal.

Emergency

- For emergency wiring please see Lutron App Note #106.

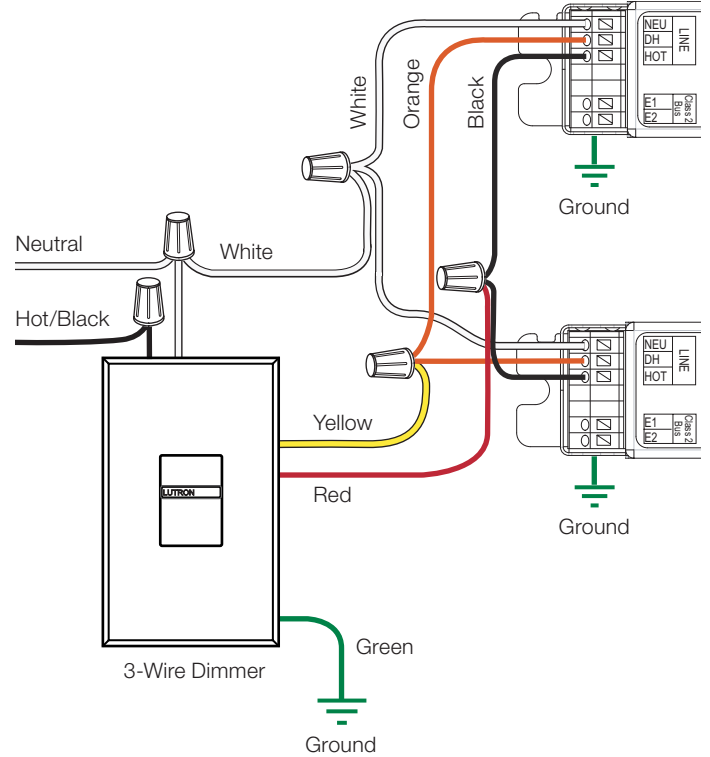

Job Name:	Model Numbers:
Job Number:	

Hi-lume 3D Wiring Diagrams

EcoSystem Digital Link Overview

- The EcoSystem Digital Link wiring (E1 and E2) connects digital ballasts and drivers together to form a lighting control system.
- Sensors do not directly connect to Hi-lume 3D ballasts.
- E1 and E2 (EcoSystem digital link wires) are polarity-insensitive and can be wired in any topology.
- An Energi Savr Node with EcoSystem unit, GRAFIK Eye QS control unit with EcoSystem, or Quantum dimming module with EcoSystem provides power for the EcoSystem digital link which supports up to 64 digital ballasts or LED drivers, 64 occupant sensors, 16 daylight sensors, and 64 wall stations or IR receivers.
- PowPak dimming module with EcoSystem provides power for the EcoSystem digital link which supports up to 32 digital ballasts or LED drivers, 6 occupant sensors, 1 daylight sensor, and 9 Pico wireless controllers.
- All EcoSystem Digital Link programming is completed by using the Energi Savr App for an *Apple iPad*, *iPod Touch*, or *iPhone* mobile digital device; GRAFIK Eye QS with EcoSystem; PowPak dimming module with EcoSystem or Quantum System.
- For complete information, see EcoSystem Design and Application Guide (P/N 3671533).
- For emergency wiring, please see Lutron App Note #106.

EcoSystem Digital Link Wiring

- Ballast EcoSystem Digital Link terminals accept one 18 AWG to 16 AWG (0.75 mm² to 1.5 mm²) solid copper wire per terminal.
- Make sure that the supply breaker to the Digital Ballast and EcoSystem Digital Link Supply is OFF when wiring.
- Connect the two conductors to the two Digital Ballast terminals E1 and E2 as shown.
- Using two different colors for E1 and E2 will reduce confusion when wiring several ballasts together.
- The EcoSystem Digital Link may be wired Class 1 or IEC PELV/NEC® Class 2. Consult applicable electrical codes for proper wiring practices.

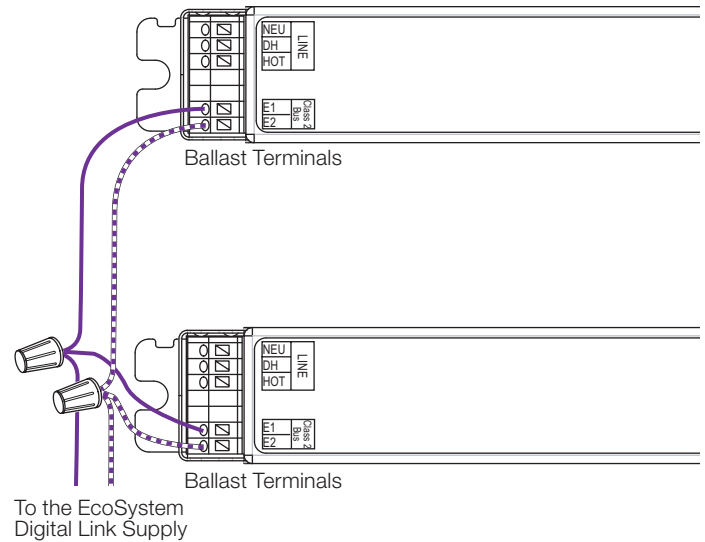

Notes

- The EcoSystem Digital Link Supply does not have to be located at the end of the Digital Link.
- EcoSystem Digital Link length is limited by the wire gauge used for E1 and E2 as follows:

Wire Gauge	Maximum Digital Link Length
12 AWG	2200 ft
14 AWG	1400 ft
16 AWG	900 ft
18 AWG	550 ft

Wire Size	Maximum Digital Link Length
4.0 mm ²	825 m
2.5 mm ²	515 m
1.5 mm ²	310 m
1.0 mm ²	205 m
0.75 mm ²	155 m

Apple, iPad, iPod Touch, and iPhone are trademarks of Apple Inc., registered in the U.S. and other countries.

Job Name:	Model Numbers:
Job Number:	

Hi-lume 3D Ballast Wiring Diagrams: T8, T5, and T5HO Linear Lamps

Wiring to One Lamp (C case shown)

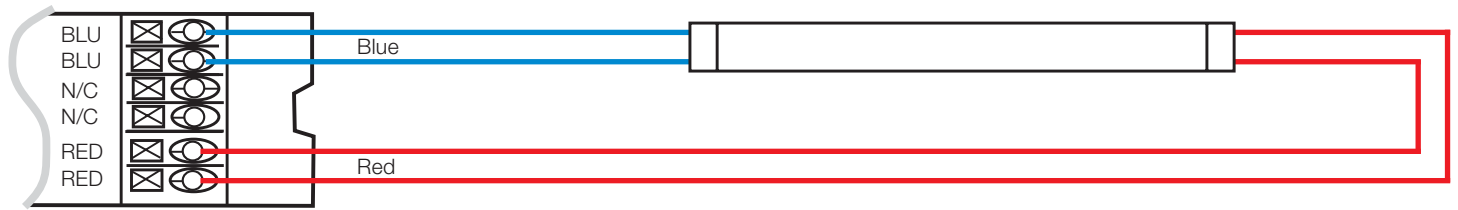

Wiring to Two Lamps (C case shown)

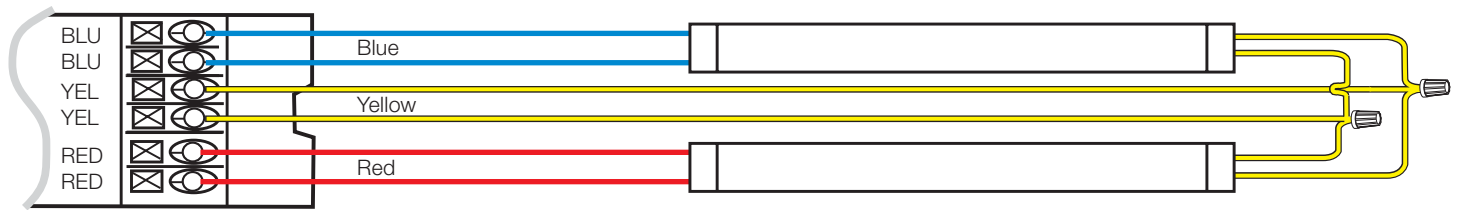

NOTICE

- Maximum ballast to lamp socket lead length is 7 ft (2 m).
- Wire colors shown are labeled on the ballast, but may vary depending upon fixture construction.

Job Name:	Model Numbers:
Job Number:	

Hi-lume 3D Ballast Wiring Diagrams: T8, T5, and T5HO Linear Lamps

Wiring to One Lamp (G case shown)

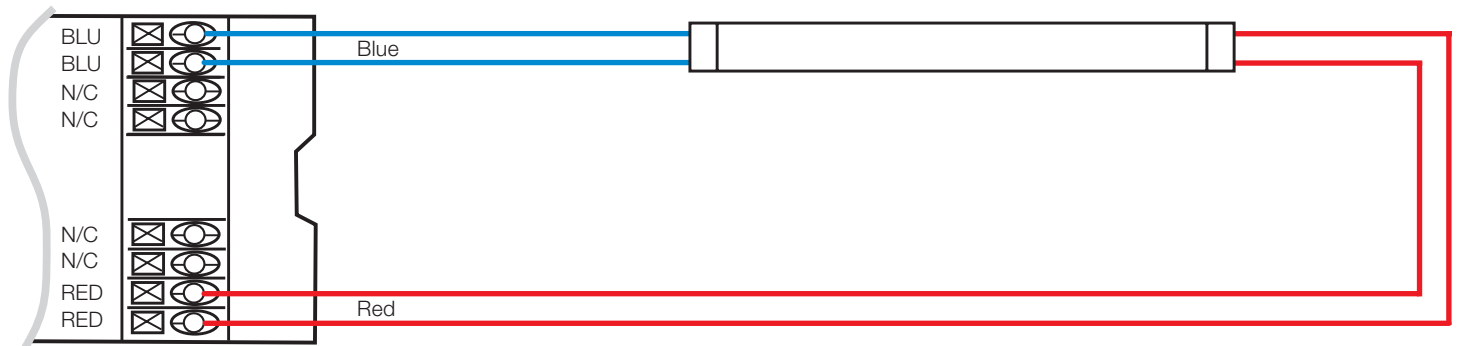

Wiring to Two Lamps (G case shown)

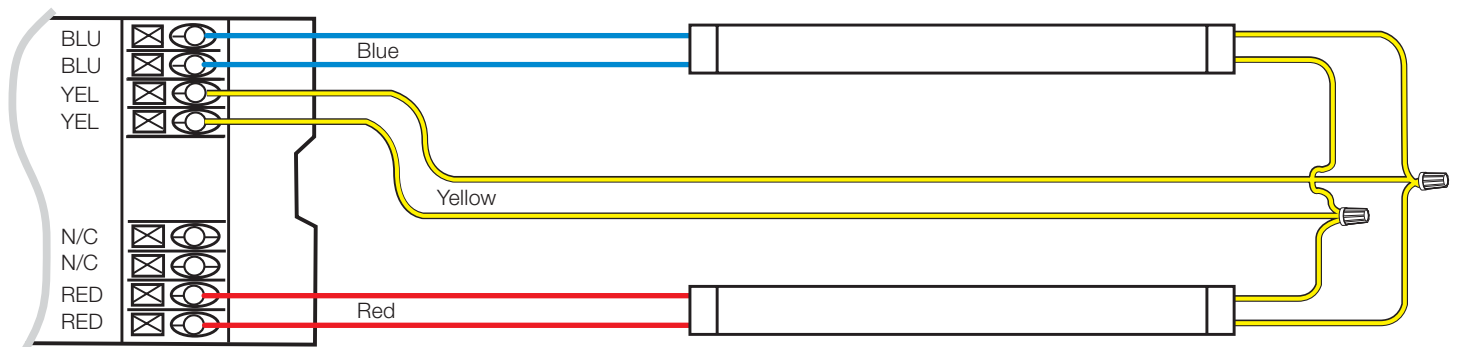

Wiring to Three Lamps (G case shown)

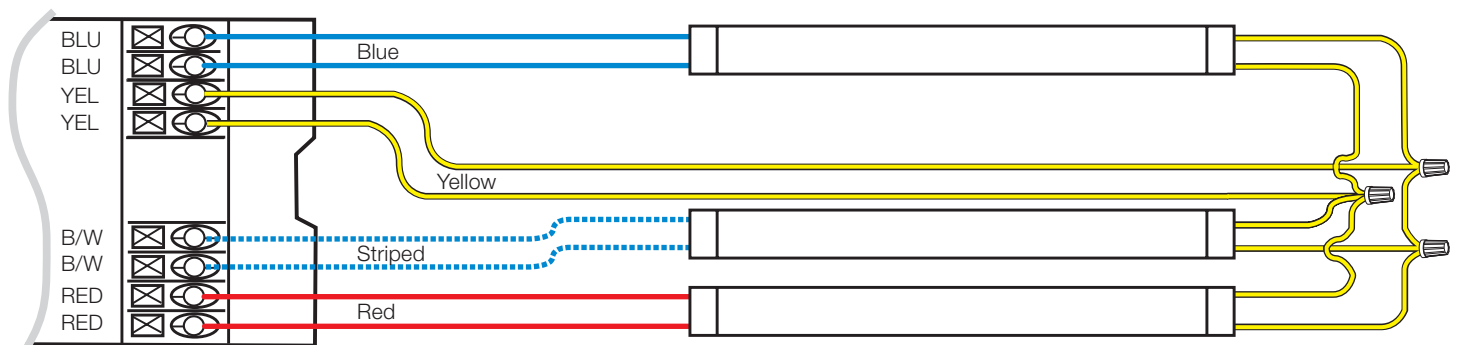

NOTICE

- Maximum ballast to lamp socket lead length is 7 ft (2 m).
- Wire colors shown are labeled on the ballast, but may vary depending upon fixture construction.

Job Name:	Model Numbers:
Job Number:	

Hi-lume 3D Ballast Wiring Diagrams: T5 Twin-Tube

Wiring to One Lamp (C case shown)

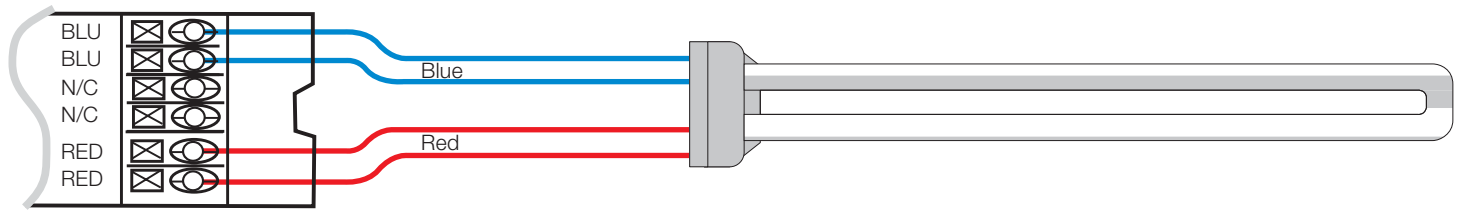

Wiring to Two Lamps (C case shown)

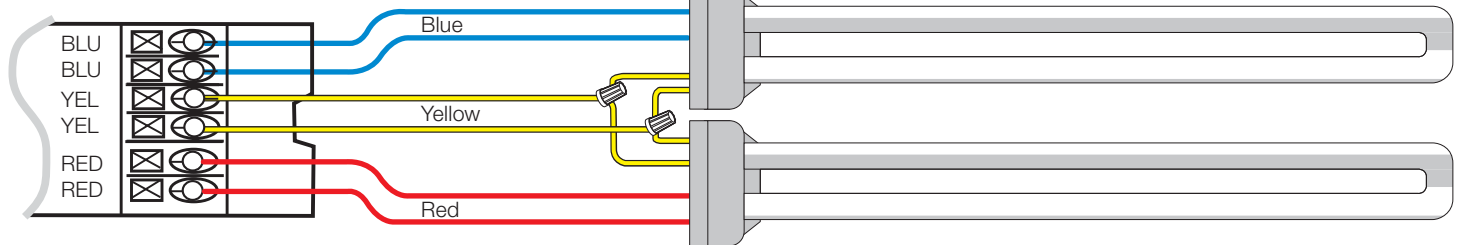

Wiring to Three Lamps (G case shown)

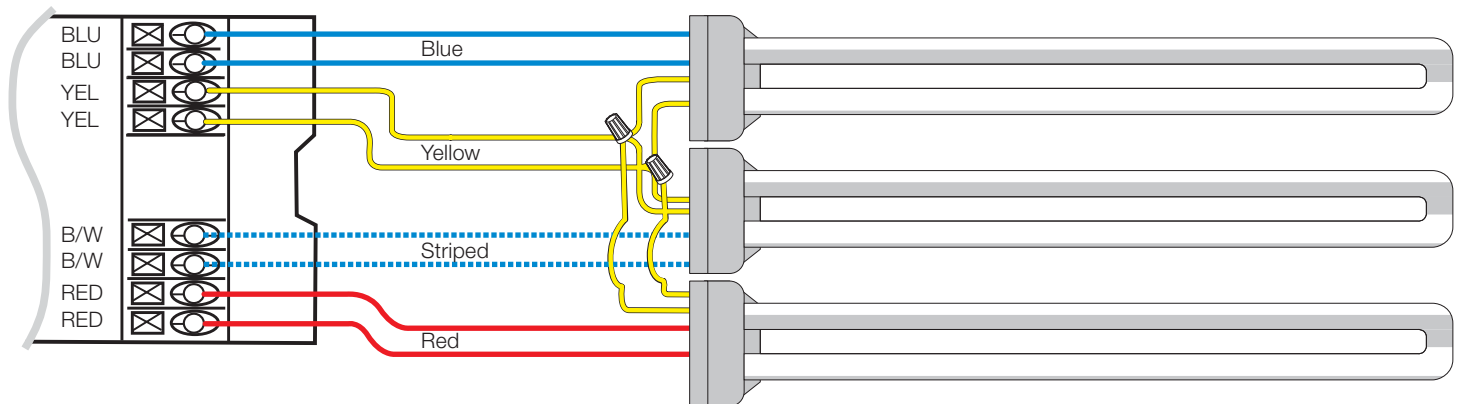

NOTICE

- Maximum ballast to lamp socket lead length is 3 ft (0.9 m).
- Wire colors shown are labeled on the ballast, but may vary depending upon fixture construction.

Job Name:	Model Numbers:
Job Number:	