



# HBX3 Premium Round High Bay

## HIGHLIGHTS

- Premium round high bay with multiple configurable options to fit almost every application
- Controls Ready makes adding controls quick and easy. Includes screw-in receptacle for Standalone sensors or Networked Lighting Controls
- Field installed battery backup options
- Includes 10ft power and dimming cord and hook for mounting ease
- Hinged junction box for easy access to internal components
- Factory modification available for high temp applications (149°F/65°C)
- Prismatic and aluminum reflector and cone lens accessories available
- PowerSet feature allows for multiple lumen stops out of the box
- FieldCCeT features provides multiple color temperature settings in one fixture

## CERTIFICATIONS

- UL listed for US & Canada
- RoHS Compliant
- FCC Compliant
- ICES-005 Compliant
- IP65 Rated
- NEMA4X Rated
- DesignLights Consortium® Premium Qualified - meets the requirements for the highest DLC qualification for efficacy and lumen maintenance
- NSF listed for Food Zone, Splash Zone and Non Food Zone (Modification by EiKO is necessary to meet NSF standards.)

## PERFORMANCE

- High efficacy, up to 160 lm/W
- Available in fixed wattage models: 150W or 200W and PowerSet models: power-selectable 150/130/100/80W, 240/220/200/180W or 300/285/270/255W models
- Available in single CCT models: 4000K or 5000K CCT or FieldCCeT models: field-selectable CCT 40/5000K
- CRI: >80
- Beam Angle: 110° (120-277V & 277-480V models) and 90° (120-347V models)
- Estimated L70: 100,000 Hours

## ELECTRICAL

- Input voltage: 120-277V, 277-480V, 120-347V
- 0-10V dimming, dim-to-off
- 12VDC Aux, 200mA max
- Surge protection: 10kV
- Power Factor: >0.9
- THD: <20%

## THERMAL

- -40°F to 131°F (-40°C to 55°C) ambient operating temperature
- Ambient operating temperature with sensor (see selected sensor datasheet)
- -40°F to 149°F (-40°C to 65°C) ambient operating temperature with high temp driver modification placement

## CONSTRUCTION

- Matte black or white powder coat, die-cast aluminum
- Impact-resistant polycarbonate lens
- 10ft power and dimming cord
- Mounting hook included

## WARRANTY

- 5-Year limited warranty available [online](#). Contact your EiKO sales rep for additional details.

## KEY FEATURES

### CONTROLS READY

Easily add controls anytime without the need for additional wiring.

### INSTALLATION MADE EASY

Yoke mount and pole adaptors available. Ships with Hook. 10ft power and dimming cord out of the box makes installation and servicing easy. Reflectors and lens available.

### HIGH TEMP APPLICATION

Factory modification moves the driver so it can operate in high temperature applications (149°F/65°C)

### ENVIRONMENTAL PROTECTION

IP65 rated, resistant to corrosion (NEMA 4X)

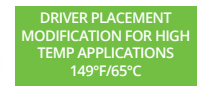

project name	type
catalog number	voltage
approved by	date



## APPLICATIONS

- Warehouses
- Manufacturing Plants
- Distribution Centers
- Grocery Stores
- Gymnasiums
- Indoor Recreational Facilities
- Cold Storage
- Big Box Retail
- Service Repair Centers

## AVAILABLE MODELS

ORDER	ORDER CODE	ITEM #	WATTS*	CCT**	LUMENS	EFFICACY (lm/W)	VOLTAGE	FINISH	TRADITIONAL WATTAGE EQUIVALENT (@MAX WATTS)	DLC ID#
										PREMIUM
	13553	HBX3-150-50-U	150W	5000K	24,000 lm	160 lm/W	120-277V	Black	Up to 400W HID	S-CVRA8J
	13555	HBX3-PS150-40-U	150/130/100/80W	4000K	24,000/20,800/16,000/12,800 lm	160 lm/W	120-277V	Black	6 lamp 4ft 32W T8 4 lamp 4ft 54W T5 400W HID	S-60NOMZ
	13556	HBX3-PS150-50-U	150/130/100/80W	5000K	24,000/20,800/16,000/12,800 lm	160 lm/W	120-277V	Black	6 lamp 4ft 32W T8 4 lamp 4ft 54W T5 400W HID	S-6PIFHT
	13561	HBX3-PS150-40-V	150/130/100/80W	4000K	24,000/20,800/16,000/12,800 lm	160 lm/W	277-480V	Black	6 lamp 4ft 32W T8 4 lamp 4ft 54W T5 400W HID	S-NSOZEX
	13562	HBX3-PS150-50-V	150/130/100/80W	5000K	24,000/20,800/16,000/12,800 lm	160 lm/W	277-480V	Black	6 lamp 4ft 32W T8 4 lamp 4ft 54W T5 400W HID	S-B13EZQ
	13567	HBX3-PS150-FCCT-H	150/130/100/80W	4000/5000K	24,000/20,800/16,000/12,800 lm	160 lm/W	120-347V	Black	6 lamwp 4ft 32W T8 4 lamp 4ft 54W T5 400W HID	S-FLH9X8
	13568	HBX3-PS150-FCCT-H-WH	150/130/100/80W	4000/5000K	24,000/20,800/16,000/12,800 lm	160 lm/W	120-347V	White	6 lamwp 4ft 32W T8 4 lamp 4ft 54W T5 400W HID	S-FLH9X8
	13554	HBX3-200-50-U	200W	5000K	34,000 lm	160 lm/W	120-277V	Black	Up to 600W HID	S-B6GY8W
	13557	HBX3-PS240-40-U	240/220/200/180W	4000K	38,400/35,200/32,000/28,800 lm	160 lm/W	120-277V	Black	6 lamp 4ft 32W T8 4 lamp 4ft 54W T5 400W HID	S-12BMOU
	13558	HBX3-PS240-50-U	240/220/200/180W	5000K	38,400/35,200/32,000/28,800 lm	160 lm/W	120-277V	Black	6 lamp 4ft 32W T8 4 lamp 4ft 54W T5 400W HID	S-1IXQ9D
	13563	HBX3-PS240-40-V	240/220/200/180W	4000K	38,400/35,200/32,000/28,800 lm	160 lm/W	277-480V	Black	6 lamp T5 HO 750W HID	S-25EGAB
	13564	HBX3-PS240-50-V	240/220/200/180W	5000K	38,400/35,200/32,000/28,800 lm	160 lm/W	277-480V	Black	6 lamp T5 HO 750W HID	S-NFJ5AR
	13569	HBX3-PS240-FCCT-H	240/220/200/180W	4000/5000K	38,400/35,200/32,000/28,800 lm	160 lm/W	120-347V	Black	6 lamp T5 HO 750W HID	S-423YB5
	13570	HBX3-PS240-FCCT-H-WH	240/220/200/180W	4000/5000K	38,400/35,200/32,000/28,800 lm	160 lm/W	120-347V	White	6 lamp T5 HO 750W HID	S-423YB5
	13559	HBX3-PS300-40-U	300/285/270/255W	4000K	48,000/45,600/43,200/40,800 lm	160 lm/W	120-277V	Black	1000W HID	S-3OV8PE
	13560	HBX3-PS300-50-U	300/285/270/255W	5000K	48,000/45,600/43,200/40,800 lm	160 lm/W	120-277V	Black	1000W HID	S-CKO87T
	13565	HBX3-PS300-40-V	300/285/270/255W	4000K	48,000/45,600/43,200/40,800 lm	160 lm/W	277-480V	Black	1000W HID	S-ME911H
	13566	HBX3-PS300-50-V	300/285/270/255W	5000K	48,000/45,600/43,200/40,800 lm	160 lm/W	277-480V	Black	1000W HID	S-074YEN

\* All power-selectable fixtures ship at the highest wattage setting

\*\* All CCT-selectable fixtures ship at 4000K

## FACTORY INSTALLED OPTIONS

CUSTOM CORD LENGTH	CORD END	HIGH TEMP	ADDITIONAL SURGE PROTECTION	NSF
<p><b>[Blank]</b> : Default, no length</p> <p><b>W1xx</b>: 300V 18/3 white cord</p> <p><b>W2xx</b>: 600V 18/3 white cord</p> <p><b>W3xx</b>: 600V 18/6 white cord with dimming wires and a 24/7 hot wire for battery backup (Cord end option is not available)</p> <p>Custom length required (in feet)</p>	<p><b>[Blank]</b> : Default, no cord end</p> <p><b>N01</b> : 125V 15A straight plug</p> <p><b>N02</b> : 250V 15A straight plug</p> <p><b>N04</b> : 125V 15A locking plug</p> <p><b>N05</b> : 250V 15A locking plug</p> <p><b>N06</b> : 277V 15A locking plug</p> <p><b>N07</b> : 125V 20A straight plug</p> <p><b>N08</b> : 250V 20A straight plug</p> <p><b>N09</b> : 277V 20A straight plug</p> <p><b>N10</b> : 125V 20A locking plug</p> <p><b>N11</b> : 250V 20A locking plug</p> <p><b>N12</b> : 277V 20A locking plug</p> <p><b>N13</b> : 347V 20A locking plug</p> <p><b>N14</b> : 480V 20A locking plug</p>	<p><b>[Blank]</b> : Default, standard driver housing</p> <p><b>HT</b> : High temp (149°F/65°C) driver housing component</p>	<p><b>[Blank]</b> : Default, no additional protection</p> <p><b>SP2</b> : 20kV surge protection</p>	<p><b>NSF</b>: NSF</p>

### MODEL CONFIGURATOR











### FACTORY INSTALLED OPTIONS

MODEL	-	WATTS	-	CCT	-	VOLTAGE	-	FINISH	-	CORD LENGTH	-	CORD END	-	HIGH TEMP	-	SURGE PROTECTION
HBX3	-		-		-		-		-		-		-		-	

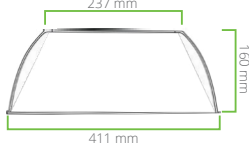
EXAMPLE PART NUMBER: HBX3-090-40-U-W120-N01-SP2

REFER TO FOLLOWING SECTIONS FOR DETAILS ON FACTORY INSTALLED OPTIONS & AVAILABLE FIELD INSTALLED OPTIONS

## ACCESSORIES

MOUNTING & PROTECTION ACCESSORIES				
ORDER	ORDER CODE	ITEM #	DESCRIPTION	IMAGE
	13821	PA-12-34*	HBX3 Pipe adaptor, 1/2" to 3/4"	
	800832	HBX2-YK-L	240-300W Mounting Yoke for HBX2 and HBX3	
	800821	HBX2-YK	100-200W Mounting Yoke for HBX2 and HBX3	
	14308	WG1-S*	Wire guard, for BAYE3 100-240W fixed power, BAYE3 150W power select, HBX3 150-200W use with reflector	
	14309	WG1-M*	Wire guard, for BAYE3 240W power select, HBX3 240-300W use with reflector	
REFLECTORS				
ORDER	ORDER CODE	ITEM #	DESCRIPTION	IMAGE
	14315	REF1-PC-S	Reflector, Prismatic, for BAYE3 100-240W fixed power, BAYE3 150W power select, HBX3 150-200W (polycarbonate)	 
	14316	REF1-PC-M	Reflector, Prismatic, for BAYE3 240W power select, HBX3 240-300W (polycarbonate)	 
	14318	REF1-CL	Cone lens, compatible with REF1-PC-S, REF1-PC-M (polycarbonate)	 
	14319	REF1-AL-S	Reflector, Aluminum, for BAYE3 100-240W fixed power, BAYE3 150W power select, HBX3 150-200W	 
	14320	REF1-AL-M	Reflector, Aluminum, for BAYE3 240W power select, HBX3 240-300W	 

\* Visit [eiko.com](http://eiko.com) for compatible alternate from previous generation

## BATTERY BACKUPS

ORDER	ORDER CODE	ITEM #	DESCRIPTION
	12901	EEBW40WHA170*	EiKO Emergency Battery External 40W 100-347VAC 170VDC Cylinder IP65 CEC Compliant. Field Installed Only.
	12902	EEBW40WVA500*	EiKO Emergency Battery External 40W 277-480VAC 310-500VDC Cylinder IP65 CEC Compliant. Field Installed Only.
	13293	RC-001	Remote Control for EEBW Emergency Battery (Optional)
	20683	WH-CAB-MN-186	3 wire dimming cable used to swap the 2 wire dimming cable; required for the sensor and battery to work together on HBX3

**\* WARNING:** When using these AC version battery backups with any control solution, internal rewiring is required according to the installation sheet's wiring diagram. Failure to do so may result in a violation of safety codes.

## CONTROLS & SENSORS: FIELD INSTALLED

ORDER	ORDER CODE	ITEM #	DESCRIPTION
<b>STANDALONE CONTROLS</b>			
<b>PIR SENSORS</b>			
	801053	HBX2-MSP	Stand-alone PIR Motion Sensor, 12V, Screw-in, Dust Gasket, 0-10V, Ambient Threshold, 20ft, Parameters set by RC02.
	13861	SEN5A-SPPR-WH	Stand-alone PIR Motion Sensor, 12-24V, Screw-in, 0-10V, Daylight Harvesting, 8-40ft, White, IP65, Parameters set by SEN5A-ACT.
<b>MICROWAVE SENSORS*</b>			
	801281	MSF-DMR-12	Stand-alone Microwave Motion Sensor, 12V, screw-in, 0-10V, Ambient Threshold, 49ft, Parameters set by RC02
	13859	SEN5A-SPMR-WH	Stand-alone Microwave Motion Sensor, 12-24V, Screw-in, 0-10V, Daylight Harvesting, 8-40ft, White, IP65, Parameters set by SEN5A-ACT.
	13341	SEN5A-SZMR-WH	Stand-alone Microwave Motion Sensor, 12-24V, Z10, 0-10V, Daylight Harvesting, 40ft, White, Parameters set by SEN5A-ACT. <b>Note:</b> Screw-in to Z10 adaptor required: SENA-APZ-WH.
	800827	HBX2-MS	Stand-alone Microwave Motion Sensor, 12V, Screw-in, Dust Gasket, 0-10V, Ambient Threshold, 40ft, Parameters set by RC02.

\* Microwave sensors must be installed on stable and immovable fixtures to avoid false activation from swinging.

<b>REMOTES FOR COMMISSIONING STANDALONE CONTROLS</b>			
	13344	SEN5A-ACT	Commissioning Tool for SEN5A, BAY-E-SEN/PIR, BAY-E-SEN/M, and MS2-DPX-3 (Backward compatible with SEN5A/CT and RC-100)
	800891	RC02	Commissioning Tool for programming HBX2, FL5, HBV2, LHB4 center pin motion sensors
<b>NETWORKED LIGHTING CONTROLS (NLC)</b>			
<b>SENSOR AND CONTROLLER</b>			
	13246	SENA-WZPA-WH	BLE PIR Motion sensor, 12-24V, IP65, Z10, 0-10V, Daylight Harvesting, 40ft, Parameters set by Silvair App. <b>Note:</b> Screw-in to Z10 adapter required: SENA-APZ-WH.
	12643	PSC-ZKV-WCM-100-BLE-SR	BLE TruBle wireless fixture Controller, 12-24V, Z10, 0-10V, Parameters set by Silvair App. <b>Note:</b> Screw-in to Z10 adapter required: SENA-APZ-WH.
<b>WALL OR WIRELESS CONTROLLERS</b>			
	12654	ESRPB-W-EO	BLE Easyfit by EnOcean wireless self-powered kinetic Single rocker pad, white, wall plate included.
	12655	EDRPB-W-EO	BLE Easyfit by EnOcean wireless self-powered kinetic Double rocker pad, white, wall plate included.
	12635	PSC-DM-WS-100-BLE-SR	BLE TruBlu 120-277V, Single Gang Single Button Wall Controller, White, Parameters set by Silvair App.
	12636	PSC-DM-I-WS-100-BLE-SR	BLE TruBlu PIR Occupancy/ Vacancy Sensor, 120-277V, Single Gang Wall Controller, White, Parameters set by Silvair App.
	12637	PSC-DM-WS-400-BLE-SR	BLE TruBlu 4-Button Wall Controller, 120-277V, Single Gang, White, Parameters set by Silvair App.
<b>ADAPTERS &amp; ACCESSORIES</b>			
	13467	SENA-APZ-WH	Z10 adaptor 1/2" Screw-in spring load pins to Z10 Receptacle IP65 White.
	12994	PSC-RET-100-BLE-SR	BLE TruBlu Range Extender, 120-277V, 800ft, Nema 4X Outdoor Enclosure
	12993	PSC-TKP-200-BLE-SR	BLE TruBlu Battery Backup Timekeeper and Range Extender, 120V, 800ft, Nema 4X Outdoor Enclosure
	13234	SGW-101	BLE Silvair Gateway SGW-101 Manufactured by Rigado (model: Cascade-500). 5-year from Silvair warranty and tech support.

# PRODUCT DIMENSIONS

## 100-200W MODELS

Weight: 8.6 lbs / 3.9 kg

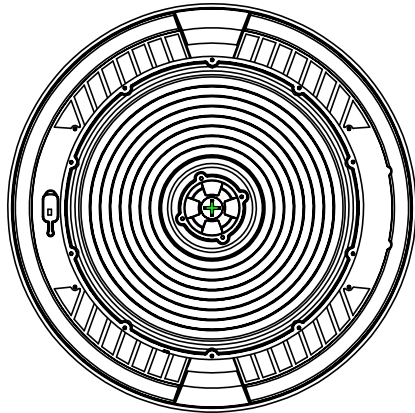
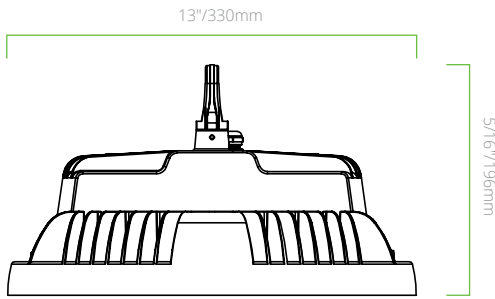

## 240-300W MODELS

Weight: 13.9 lbs / 6.3 kg

