

Project		Catalog #		Type	
Prepared by		Notes		Date	



HALO

HL36A | TL3

3" Shallow Directional New Construction LED Housing and Trims

Typical Applications

Residential, Light Commercial

Interactive Menu

- Order Information [page 2](#)
- Product Specifications [page 4](#)
- Photometric Data [page 5](#)
- Energy & Performance Data [page 3](#)
- Dimming Guide
- Product Warranty



Refer to ENERGY STAR® Certified Products List.
Can be used to comply with California Title 24 High Efficacy requirements.
Certified to California Appliance Efficiency Database under JAB. ¹



Top Product Features

- Broad range of trims, distribution can easily be changed in the field
- Optional adapter allows rimless installation
- Interchangeable 15°, 25°, 40° and 55° LED optics provide focus
- Flicker-free dimming down to 1%, available with LE/TE phase cut and 0-10V analog control
- Locking 365° rotation and 45° tilt holds any aiming position
- Options to meet Trade Agreements Act requirements

Dimensional and Mounting Details

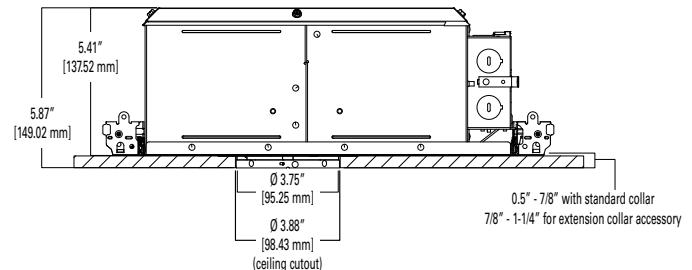
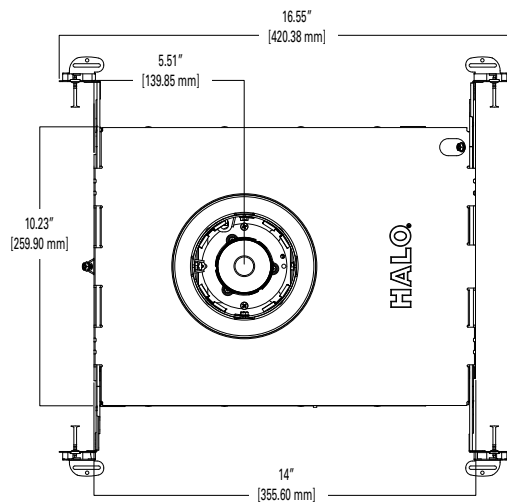







Note: For use in shallow ceilings with 2" x 6" joist construction.

Order Information







SAMPLE ORDER NUMBER: **HL36A20927ED010ICAT, TIR45SP15, TL3RMW**

A complete luminaire consists of a housing, TIR optic, and trim.



Domestic Preferences	Models	Wattage	Distribution	Light Engine	Input/Control	Housing Type	Accessories
Domestic Preferences ⁽¹⁾	Models	Wattage	Distribution ⁽²⁾	Light Engine	Input/Control	Housing Type	Accessories ⁽⁴⁾
[Blank] =Standard TAA =Trade Agreements Act	HL36A = 3" shallow new construction directional housing	10 = 10W (nominal) 15 = 15W (nominal) 20 = 20W (nominal)	[blank] = Purchase optic separately	927 = 90 CRI, 2700K 930 = 90 CRI, 3000K 935 = 90 CRI, 3500K 940 = 90 CRI, 4000K D2W = 90 CRI, 3000K CCT, dim to warm ⁽³⁾	ED010 = UNV 120-277V 50/60Hz leading or trailing edge phase cut 1% dimming at 120V only and UNV 120-277V 50/60Hz 0-10V 1% dimming DE010 = 0-10V Dimming, 0% to 100%, 120V-277V	ICAT = insulation contact and airtight	RA3R = rimless adapter for HL36A housings and trims CE3R = collar extender for HL36A housings, adjusts from 7/8" to 1-1/4" thick ceilings OTL3MW = oversized trim ring for TL3 trims Optics TIR45SP15 = 15° beam TIR45NFL25 = 25° beam TIR45FL40 = 40° beam TIR45WFL55 = 55° beam TIR45MH12PK = replacement media holder, package of 12 L100 Series = 2.0" lens and filters, see spec sheet
Notes <small>(1) Only product configurations with this designated prefix are built to be compliant with the Trade Agreements Act of 1979 (TAA) Please refer to DOMESTIC PREFERENCES website for more information. Components shipped separately may be separately analyzed under domestic preference requirements...</small>	Notes	Notes	Notes <small>(2) Add necessary optic as an accessory.</small>	Notes <small>(3) Only available in 10W and 15W</small>	Notes	Notes	Notes <small>(4) Accessories sold separately will be separately analyzed under domestic preference requirements. Consult factory for further information.</small>

Trim	Shielding	Finishes	Flange
 TL3PIN = 2.00" aperture pinhole w/oculus, open, self-flanged	[blank] = open	Electroplated Finishes BNBB = brushed nickel flange, black oculus ORBBB = oil rubbed bronze flange, black oculus Painted Finishes MWWB = matte white flange, white oculus MWBB = matte white flange, black oculus MBBB = matte black flange, black oculus	[blank] = full overlap self-flanged
 TL3PIN = 2.00" aperture pinhole w/oculus, lens, self-flanged	2G = micro-prismatic lens	Electroplated Finishes ORBBB = oil rubbed bronze flange, black oculus Painted Finishes MWWB = matte white flange, white oculus MWBB = matte white flange, black oculus MBBB = matte black flange, black oculus	[blank] = full overlap self-flanged
 TL3PIN = 2.00" aperture pinhole w/oculus, lens, rimless	2G = micro-prismatic lens	Painted Finishes MWWB = matte white flange, white oculus	RL = rimless, must be used with rimless adapter ordered separately
 TL3R = 3.25" aperture conical reflector, open, self-flanged	[blank] = open	Anodized Finishes H = semi-specular clear reflector and flange HWF = semi-specular clear reflector and matte white flange Electroplated Finishes BN = brushed nickel reflector and flange ORB = oil rubbed bronze reflector and flange Painted Finishes MW = matte white reflector and flange MB = matte black reflector and flange	[blank] = full overlap self-flanged
 TL3R = 3.25" aperture conical reflector, open, rimless	[blank] = open	Painted Finishes MW = matte white reflector and flange	RL = rimless, must be used with rimless adapter ordered separately
 TL3R = 3.25" aperture conical reflector, open, self-flanged	2G = micro-prismatic lens	Anodized Finishes H = semi-specular clear reflector and flange HWF = semi-specular clear reflector and matte white flange Electroplated Finishes BN = brushed nickel reflector and flange ORB = oil rubbed bronze reflector and flange Painted Finishes MW = matte white reflector and flange MB = matte black reflector and flange	[blank] = full overlap self-flanged

Order Information

	Trim	Shielding	Finishes	Flange
	TL3R = 3.25" aperture conical reflector, open, rimless	2G = micro-prismatic lens	<u>Painted Finishes</u> MW = matte white reflector and flange	RL = rimless, must be used with rimless adapter ordered separately
	TL3R = 3.25" aperture conical baffle, open, self-flanged	[blank] = open	<u>Painted Finishes</u> BBWF = matte black baffle, matte white flange WBWF = matte white baffle, matte white flange	[blank] = full overlap self-flanged
	TL3R = 3.25" aperture conical baffle, open, self-flanged	2G = micro-prismatic lens	<u>Painted Finishes</u> BBWF = matte black baffle, matte white flange WBWF = matte white baffle, matte white flange	[blank] = full overlap self-flanged
	TL3PR = 3.25" aperture conical polymer reflector, lens, self-flanged	2G = micro-prismatic lens	<u>Painted Finishes</u> MW = matte white reflector and flange	[blank] = full overlap self-flanged
	TL3LWW = 3.25" aperture conical lens wall wash, self-flanged	6G = linear spread lens	<u>Anodized Finishes</u> H = semi-specular clear reflector and flange HWF = semi-specular clear reflector and matte white flange <u>Painted Finishes</u> MW = matte white reflector and flange	[blank] = full overlap self-flanged
	TL3LWW = 3.25" aperture conical lens wall wash, rimless	6G = linear spread lens	<u>Painted Finishes</u> MW = matte white reflector and flange	RL = rimless

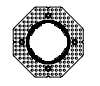
Lens trims are wet location listed, covered ceilings only and IP44 rated.

Accessory				
	RA3R = Rimless adapter for HL3xR housings and trims			
	CE3R = Collar extender for HL3xR housings, adjusts from 7/8" to 1-1/4" thick ceilings			
	OTL3MW = 3" Oversized trim ring, matte white			

Energy Data

ED010 Driver

Input Voltage	120V	277V
Input Current	0.17 (A)	0.08 (A)
Input Power	19.5 (W)	19.4 (W)
Inrush (A)	6.2 (A)	13.8 (A)
THD	≤ 20%	≤ 20%
PF	≥ 0.90	≥ 0.90
T Ambient	-40 - +40°C	-40 - +40°C
Sound Rating	≤ 22dba	≤ 22dba

1ELTE Driver

Input Voltage	120V
Input Current	0.19 (A)
Input Power	21.8 (W)
Inrush (A)	1.15 (A)
THD	≤ 20%
PF	≥ 0.90
T Ambient	-40 - +40°C
Sound Rating	≤ 22dba

DE010 Driver

Input Voltage	120V	277V
Input Current	0.17 (A)	0.09 (A)
Input Power	19.8 (W)	20.6 (W)
Inrush (A)	1.1 (A)	2.5 (A)
THD	≤ 20%	≤ 20%
PF	≥ 0.90	≥ 0.90
T Ambient	-40 - +40°C	-40 - +40°C
Sound Rating	≤ 22dba	≤ 22dba

Product Specifications

Frame

- Galvanized steel plaster frame with integral bar hanger receivers
- Setscrew provide positive horizontal locking
- Collar adjusts vertically to accommodate 1/2" to 7/8" thick ceilings and locks in position with (4) screws
- Use optional collar extender for 7/8" to 1-1/4" thick ceilings
- Integral gun sights facilitate the use of guide strings or laser lines
- Shipped with overspray protector installed

Housing

- Steel housing painted matte black for a visually dark interior
- Removable top allows service from above

Bar Hangers

- GOT NAIL! Gen 3 bar hangers adjust from 10-1/2" to 24" wide
- Captive nail penetrates standard and engineered lumber
- Mounting flange levels platform with ceiling
- Integral clip attaches directly to tee-bar

Gaskets

- Gaskets achieve restrictive airflow requirements without additional caulking

Adjustment Mechanism

- Rotates 365°, tilts 45° and locks in position maintaining any aiming angle
- Angle markings assist in repeatable settings
- Translating center beam optics aligns axis of primary reflector with aperture from nadir to 45°

Trim Retention

- Attached by (8) rare earth Neodymium magnets, holds trim securely to the ceiling
- Tether secures trim to housing during service or adjustment

LED Module

- LED array is field replaceable
- Proximity phosphors over chip on board LEDs provide a uniform source with high efficiency and no pixilation
- Color accuracy within 3 SDCM and 90 CRI minimum
- Passive cooling achieves L70 at 50,000 hours

Primary Optic

- Precision molded TIR optics deliver highly efficient and uniform patterns
- Various patterns are available and can be interchanged without tools

Media

- Integral media holder accepts up to (2) 2" diameter 3.0mm thick color filters or lens
- Order color filters and lens separately

Trims

- Die cast aluminum trims are available in open, lens and lens wall wash styles
- Polymer non-conductive trim meets many local code requirements for 'dead front'
- Physical and optical cutoff provides visual comfort
- Light trap eliminates spill light with flange
- Multiple finishes to match many décors
- Available in self-flanged or rimless styles with optional rimless adapter

Shielding

- Micro-prismatic lens standard with lens trims
- Hinged to allow rimless trim removal

Driver

- Field replaceable constant current driver provides noise free operation
- UNV 120-277VAC 50/60Hz input
- Continuous, flicker-free 1% dimming, available with LE and TE phase cut (at 120V only) and 0-10V analog control

Junction Box

- Galvanized steel junction box with 18in3 internal volume
- Listed for (12) #12 AWG 90° C splice conductors
- (7) 1/2" conduit pry-outs positioned to allow straight conduit runs
- (3) Slide-N-Side™ non-metallic (NM) wire traps
- Accepts 14-2, 14-3, 12-2, 12-3 U.S. and 14-2, 14-3, 12-2 Canadian NM cable
- (3) 4-port push wire nuts mains voltage connections

Compliance

- Type IC inherently protected, suitable for direct contact to air permeable insulation and cULus listed for damp locations
- Not for use in direct contact with spray foam insulation, consult NEMA LSD57-2013
- Wet location listed in covered ceilings. Housing is IP20 certified and when installed with a lens trim IP55 certified below the ceiling in covered ceiling applications only
- Airtight per ASTM-E283-04
- Suitable for use in clothes closets when installed in accordance with the NEC 410.16 spacing requirements
- EMI/RFI emissions per FCC 47CFR Part 15 consumer limits
- Contains no mercury or lead and RoHS compliant¹
- Photometric testing in accordance with IES LM-79-08
- Lumen maintenance projections in accordance with IES LM-80-08 and TM-21-11
- Can be used for State of California Title 24 high efficacy LED compliance under JA8, reference Modernized Appliance Efficiency Database System (MAEDBS) for 2016 JA8 High Efficacy Lighting¹
- ENERGY STAR® certified, reference certified light fixtures database

Warranty

- Five year limited warranty, consult website for details. www.cooperlighting.com/warranty

Photometric Data - Multiplier Tables

Wattage Multipliers

Wattage	10W	15W	20W
Multiplier	0.520883275	0.736897133	1.00000

Multipliers for relative lumen values with other wattage options.

CCT Multipliers

CCT	D2W	2700K	3000K	3500K	4000K
Multiplier	0.49733	0.93842	1.00000	1.05535	1.07038

Multipliers for relative lumen values with other color temperatures.

Driver Multipliers

Driver	ED010	DE010	1ELTE
Multiplier	1.00000	1.00000	1.02108

Multipliers for relative lumen values with other driver options.

Color Finish Multipliers when tilted at 30°

Trim	TL3R			TL3LWW & TL3PIN
	BN	ORB, MB, BBWF	H, HWF, MW, WBWF	N/A Trim is not exposed to direct light
Multiplier	0.95800	0.97000	1.00000	

Multipliers for relative lumen values with other color finish options.

Optic Details

Optic	BEAM	FIELD	LUMENS	LPW	CBCP
SP	16.8	30.5	1644	84	15266
NFL	26.1	43.4	1765	91	8046
FL	38.9	57.8	1754	90	4177
WFL	53.9	79.3	1609	83	2065

Photometric performance for TL3RWBWF 3000K CCT

Photometric Data - Spot

 [View IES files](#)

SUMMARY TABLE	
Filename	HL36A20SP930ED010TL3RMW.ies
Test No.	P284171
Lumcat	HL36A20SP930ED010TL3RMW
Lumens	1644 Lm
Watts	19.5 W
LPW	84.3 Lm/W
CCT	3000K
SC (0/90/45)	0.29 / 0.29 / 0.28

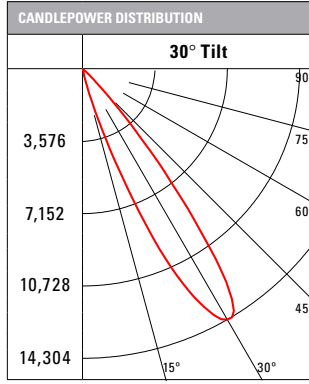
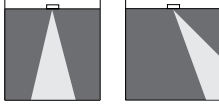

CONE OF LIGHT													
0 deg Aiming Angle Horizontal Illuminance on Floor				30 deg Aiming Angle Horizontal Illuminance on Floor				30 deg Aiming Angle Vertical Illuminance on Wall					
MH	FC	L	W	MH	FC	L	W	CB	D	FC	L	W	CB
4.5'	753.9	1.2	1.2	4.5'	463.7	1.6	1.4	2.6	3'	241.2	2.5	1.6	5.2
5.5'	504.7	1.4	1.4	5.5'	310.4	1.9	1.8	3.2	4'	135.7	3.4	2	6.9
6.5'	361.3	1.8	1.8	6.5'	222.3	2.4	2.2	3.8	6'	60.3	5.1	3.2	10.4
8'	238.5	2.2	2.2	8'	146.7	2.9	2.6	4.6	8'	33.9	6.8	4.2	13.9
10'	152.7	2.8	2.8	10'	93.9	3.7	3.4	5.8	10'	21.7	8.5	5.4	17.3
12'	106	3.4	3.4	12'	65.2	4.5	4	6.9	12'	15.1	10.3	6.4	20.8

SUMMARY TABLE	
Filename	HL36A20SP930ED010TL3R2GMW.ies
Test No.	P284170
Lumcat	HL36A20SP930ED010TL3R2GMW
Lumens	1553 Lm
Watts	19.5 W
LPW	79.6 Lm/W
CCT	3000K
SC (0/90/45)	0.31 / 0.31 / 0.31

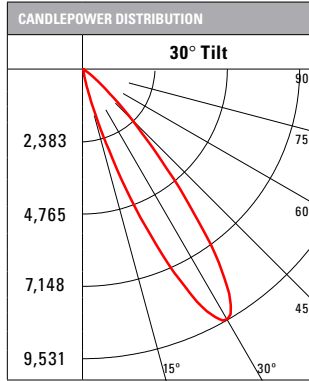
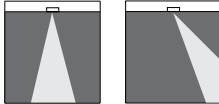

CONE OF LIGHT													
0 deg Aiming Angle Horizontal Illuminance on Floor				30 deg Aiming Angle Horizontal Illuminance on Floor				30 deg Aiming Angle Vertical Illuminance on Wall					
MH	FC	L	W	MH	FC	L	W	CB	D	FC	L	W	CB
4.5'	588.9	1.2	1.2	4.5'	314.6	1.8	1.6	2.6	3'	163.8	2.9	1.6	5.2
5.5'	394.2	1.6	1.6	5.5'	210.6	2.2	2	3.2	4'	92.1	4	2.2	6.9
6.5'	282.2	2	2	6.5'	150.8	2.6	2.2	3.8	6'	41	5.9	3.4	10.4
8'	186.3	2.4	2.4	8'	99.5	3.2	2.8	4.6	8'	23	8	4.6	13.9
10'	119.2	3	3	10'	63.7	4	3.6	5.8	10'	14.7	10	5.8	17.3
12'	82.8	3.6	3.6	12'	44.2	4.7	4.2	6.9	12'	10.2	12	7	20.8

SUMMARY TABLE	
Filename	HL36A20SP930ED010TL3PINMWWB.ies
Test No.	P284169
Lumcat	HL36A20SP930ED010TL3PINMWWB
Lumens	1539 Lm
Watts	19.5 W
LPW	78.9 Lm/W
CCT	3000K
SC (0/90/45)	0.29 / 0.29 / 0.28

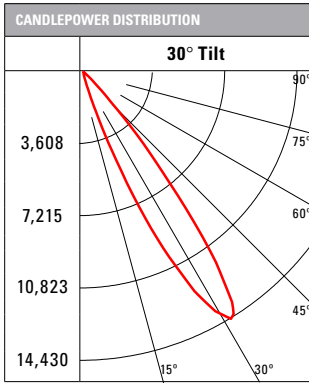
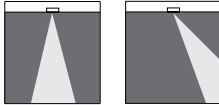

CONE OF LIGHT													
0 deg Aiming Angle Horizontal Illuminance on Floor				30 deg Aiming Angle Horizontal Illuminance on Floor				30 deg Aiming Angle Vertical Illuminance on Wall					
MH	FC	L	W	MH	FC	L	W	CB	D	FC	L	W	CB
4.5'	754	1.2	1.2	4.5'	450.6	1.5	1.4	2.6	3'	243.8	2.4	1.4	5.2
5.5'	504.8	1.4	1.4	5.5'	301.6	1.9	1.8	3.2	4'	137.1	3.2	2	6.9
6.5'	361.4	1.8	1.8	6.5'	216	2.2	2	3.8	6'	60.9	4.8	3	10.4
8'	238.6	2.2	2.2	8'	142.6	2.8	2.6	4.6	8'	34.3	6.5	4	13.9
10'	152.7	2.8	2.8	10'	91.2	3.5	3.2	5.8	10'	21.9	8.1	5	17.3
12'	106	3.4	3.4	12'	63.4	4.2	3.8	6.9	12'	15.2	9.7	6.2	20.8

SUMMARY TABLE	
Filename	HL36A20SP930ED010TL3PIN2GMWWB.ies
Test No.	P284168
Lumcat	HL36A20SP930ED010TL3PIN2GMWWB
Lumens	1413 Lm
Watts	19.5 W
LPW	72.5 Lm/W
CCT	3000K
SC (0/90/45)	0.31 / 0.31 / 0.31

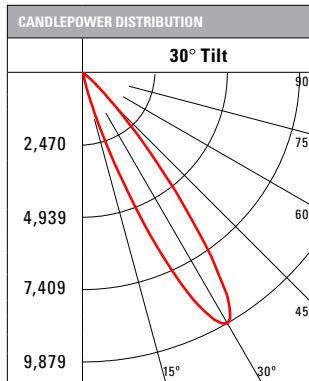
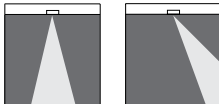

CONE OF LIGHT													
0 deg Aiming Angle Horizontal Illuminance on Floor				30 deg Aiming Angle Horizontal Illuminance on Floor				30 deg Aiming Angle Vertical Illuminance on Wall					
MH	FC	L	W	MH	FC	L	W	CB	D	FC	L	W	CB
4.5'	570.9	1.2	1.2	4.5'	321.4	1.6	1.6	2.6	3'	160.2	2.7	1.6	5.2
5.5'	382.2	1.6	1.6	5.5'	215.2	1.9	1.8	3.2	4'	90.1	3.6	2.2	6.9
6.5'	273.6	1.8	1.8	6.5'	154.1	2.4	2.2	3.8	6'	40.1	5.5	3.4	10.4
8'	180.6	2.4	2.4	8'	101.7	2.9	2.8	4.6	8'	22.5	7.4	4.6	13.9
10'	115.6	3	3	10'	65.1	3.7	3.6	5.8	10'	14.4	9.3	5.8	17.3
12'	80.3	3.6	3.6	12'	45.2	4.4	4.2	6.9	12'	10	11.2	7	20.8

 [View Multipliers](#)

Photometric Data - Narrow Flood

[View IES files](#)

SUMMARY TABLE	
Filename	HL36A20NFL930ED010TL3RMW.ies
Test No.	P284155
Lumcat	HL36A20NFL930ED010TL3RMW
Lumens	1765 Lm
Watts	19.5 W
LPW	90.5 Lm/W
CCT	3000K
SC (0/90/45)	0.44 / 0.44 / 0.42

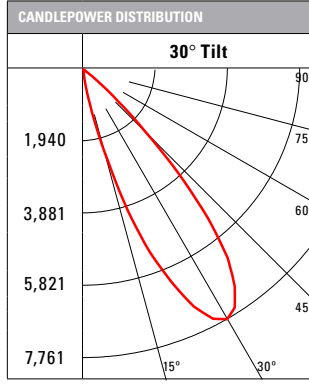
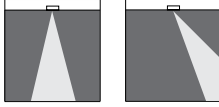

CONE OF LIGHT															
0 deg Aiming Angle Horizontal Illuminance on Floor					30 deg Aiming Angle Horizontal Illuminance on Floor					30 deg Aiming Angle Vertical Illuminance on Wall					
MH	FC	L	W		MH	FC	L	W	CB		D	FC	L	W	CB
4.5'	397.4	1.8	1.8		4.5'	260.8	2.3	2.2	2.6		3'	160.2	2.8	2	5.2
5.5'	266	2.4	2.4		5.5'	174.6	2.8	2.8	3.2		4'	90.1	3.8	2.8	6.9
6.5'	190.5	2.8	2.8		6.5'	125	3.3	3.2	3.8		6'	40.1	5.7	4.2	10.4
8'	125.7	3.4	3.4		8'	82.5	4.1	4	4.6		8'	22.5	7.7	5.6	13.9
10'	80.5	4.4	4.4		10'	52.8	5.2	5	5.8		10'	14.4	9.7	7	17.3
12'	55.9	5.2	5.2		12'	36.7	6.3	6.2	6.9		12'	10	11.6	8.4	20.8

SUMMARY TABLE	
Filename	HL36A20NFL930ED010TL3R2GMW.ies
Test No.	P284154
Lumcat	HL36A20NFL930ED010TL3R2GMW
Lumens	1655 Lm
Watts	19.5 W
LPW	84.9 Lm/W
CCT	3000K
SC (0/90/45)	0.45 / 0.45 / 0.44

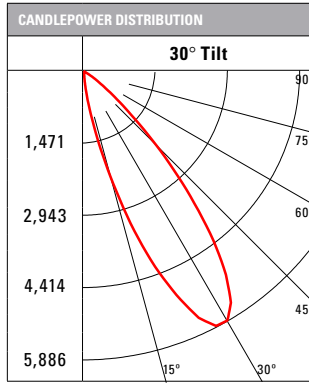
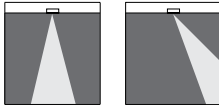

CONE OF LIGHT															
0 deg Aiming Angle Horizontal Illuminance on Floor					30 deg Aiming Angle Horizontal Illuminance on Floor					30 deg Aiming Angle Vertical Illuminance on Wall					
MH	FC	L	W		MH	FC	L	W	CB		D	FC	L	W	CB
4.5'	328.2	2	2		4.5'	204.6	2.3	2.2	2.6		3'	109.6	3.3	2.2	5.2
5.5'	219.7	2.4	2.4		5.5'	137	2.8	2.6	3.2		4'	61.6	4.5	2.8	6.9
6.5'	157.3	2.8	2.8		6.5'	98.1	3.3	3.2	3.8		6'	27.4	6.7	4.4	10.4
8'	103.8	3.4	3.4		8'	64.7	4.1	4	4.6		8'	15.4	9	5.8	13.9
10'	66.5	4.4	4.4		10'	41.4	5.1	5	5.8		10'	9.9	11.3	7.4	17.3
12'	46.1	5.2	5.2		12'	28.8	6.2	6	6.9		12'	6.8	13.5	8.8	20.8

SUMMARY TABLE	
Filename	HL36A20NFL930ED010TL3PINMWWB.ies
Test No.	P284153
Lumcat	HL36A20NFL930ED010TL3PINMWWB
Lumens	1670 Lm
Watts	19.5 W
LPW	85.6 Lm/W
CCT	3000K
SC (0/90/45)	0.44 / 0.44 / 0.41

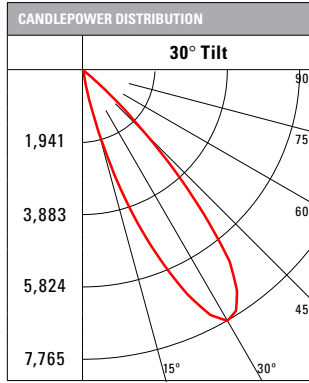
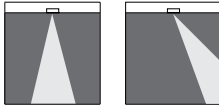

CONE OF LIGHT															
0 deg Aiming Angle Horizontal Illuminance on Floor					30 deg Aiming Angle Horizontal Illuminance on Floor					30 deg Aiming Angle Vertical Illuminance on Wall					
MH	FC	L	W		MH	FC	L	W	CB		D	FC	L	W	CB
4.5'	398.7	1.8	1.8		4.5'	255.2	2.2	2	2.6		3'	162.4	2.7	2	5.2
5.5'	266.9	2.4	2.4		5.5'	170.9	2.7	2.6	3.2		4'	91.4	3.6	2.6	6.9
6.5'	191.1	2.8	2.8		6.5'	122.3	3.2	3	3.8		6'	40.6	5.5	4	10.4
8'	126.2	3.4	3.4		8'	80.8	4.1	3.8	4.6		8'	22.8	7.3	5.2	13.9
10'	80.7	4.4	4.4		10'	51.7	5.1	4.8	5.8		10'	14.6	9.1	6.6	17.3
12'	56.1	5.2	5.2		12'	35.9	6.1	5.6	6.9		12'	10.2	11	8	20.8

SUMMARY TABLE	
Filename	HL36A20NFL930ED010TL3PIN2GMWWB.ies
Test No.	P284152
Lumcat	HL36A20NFL930ED010TL3PIN2GMWWB
Lumens	1563 Lm
Watts	19.5 W
LPW	80.2 Lm/W
CCT	3000K
SC (0/90/45)	0.44 / 0.44 / 0.43

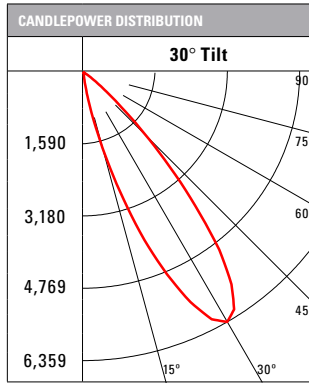
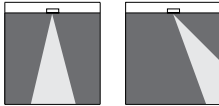

CONE OF LIGHT															
0 deg Aiming Angle Horizontal Illuminance on Floor					30 deg Aiming Angle Horizontal Illuminance on Floor					30 deg Aiming Angle Vertical Illuminance on Wall					
MH	FC	L	W		MH	FC	L	W	CB		D	FC	L	W	CB
4.5'	347.1	1.8	1.8		4.5'	211.7	2.2	2	2.6		3'	123.7	3	2	5.2
5.5'	232.3	2.4	2.4		5.5'	141.7	2.7	2.6	3.2		4'	69.6	3.9	2.6	6.9
6.5'	166.3	2.8	2.8		6.5'	101.5	3.2	3	3.8		6'	30.9	6	4	10.4
8'	109.8	3.4	3.4		8'	67	3.9	3.8	4.6		8'	17.4	8	5.4	13.9
10'	70.3	4.4	4.4		10'	42.9	5	4.8	5.8		10'	11.1	10.1	6.8	17.3
12'	48.8	5.2	5.2		12'	29.8	6	5.8	6.9		12'	7.7	12.1	8.2	20.8

[View Multipliers](#)

Photometric Data - Flood

[View IES files](#)

SUMMARY TABLE	
Filename	HL36A20FL930ED010TL3RMW.ies
Test No.	P284139
Lumcat	HL36A20FL930ED010TL3RMW
Lumens	1754 Lm
Watts	19.5 W
LPW	90 Lm/W
CCT	3000K
SC (0/90/45)	0.65 / 0.65 / 0.59

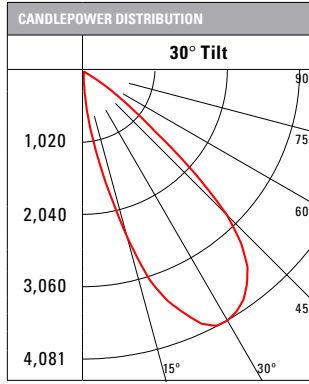
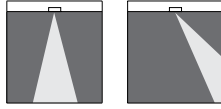

CONE OF LIGHT														
0 deg Aiming Angle Horizontal Illuminance on Floor					30 deg Aiming Angle Horizontal Illuminance on Floor					30 deg Aiming Angle Vertical Illuminance on Wall				
MH	FC	L	W		MH	FC	L	W	CB	D	FC	L	W	CB
4.5'	206.3	2.8	2.8		4.5'	145.2	3	2.8	2.6	3'	113.4	2.6	2.6	5.2
5.5'	138.1	3.4	3.4		5.5'	97.2	3.7	3.6	3.2	4'	63.8	3.6	3.4	6.9
6.5'	98.9	4.2	4.2		6.5'	69.6	4.4	4.2	3.8	6'	28.4	5.4	5.2	10.4
8'	65.3	5	5		8'	45.9	5.4	5.2	4.6	8'	16	7.3	7	13.9
10'	41.8	6.4	6.4		10'	29.4	6.7	6.6	5.8	10'	10.2	9.2	8.8	17.3
12'	29	7.6	7.6		12'	20.4	8.2	7.8	6.9	12'	7.1	11	10.6	20.8

SUMMARY TABLE	
Filename	HL36A20FL930ED010TL3R2GMW.ies
Test No.	P284138
Lumcat	HL36A20FL930ED010TL3R2GMW
Lumens	1645 Lm
Watts	19.5 W
LPW	84.4 Lm/W
CCT	3000K
SC (0/90/45)	0.63 / 0.63 / 0.6

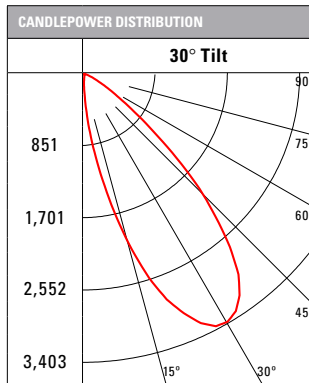
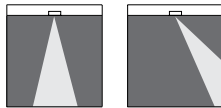

CONE OF LIGHT														
0 deg Aiming Angle Horizontal Illuminance on Floor					30 deg Aiming Angle Horizontal Illuminance on Floor					30 deg Aiming Angle Vertical Illuminance on Wall				
MH	FC	L	W		MH	FC	L	W	CB	D	FC	L	W	CB
4.5'	183.4	2.8	2.8		4.5'	120.2	2.9	2.8	2.6	3'	79.7	3.2	2.6	5.2
5.5'	122.8	3.4	3.4		5.5'	80.5	3.6	3.6	3.2	4'	44.8	4.3	3.6	6.9
6.5'	87.9	4	4		6.5'	57.6	4.3	4.2	3.8	6'	19.9	6.5	5.4	10.4
8'	58	5	5		8'	38	5.2	5.2	4.6	8'	11.2	8.8	7.4	13.9
10'	37.1	6.2	6.2		10'	24.3	6.6	6.4	5.8	10'	7.2	11	9.2	17.3
12'	25.8	7.4	7.4		12'	16.9	8	7.8	6.9	12'	5	13.2	11	20.8

SUMMARY TABLE	
Filename	HL36A20FL930ED010TL3PINMWWB.ies
Test No.	P284137
Lumcat	HL36A20FL930ED010TL3PINMWWB
Lumens	1644 Lm
Watts	19.5 W
LPW	84.3 Lm/W
CCT	3000K
SC (0/90/45)	0.64 / 0.64 / 0.58

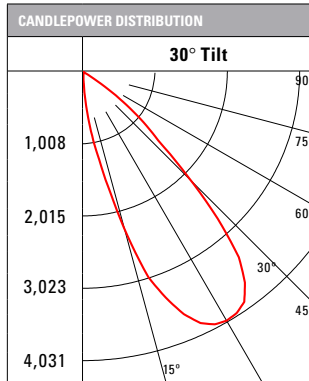
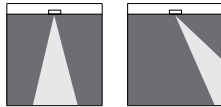

CONE OF LIGHT														
0 deg Aiming Angle Horizontal Illuminance on Floor					30 deg Aiming Angle Horizontal Illuminance on Floor					30 deg Aiming Angle Vertical Illuminance on Wall				
MH	FC	L	W		MH	FC	L	W	CB	D	FC	L	W	CB
4.5'	206.1	2.8	2.8		4.5'	143.4	2.8	2.8	2.6	3'	100.2	2.9	2.4	5.2
5.5'	137.9	3.4	3.4		5.5'	96	3.4	3.4	3.2	4'	56.4	3.9	3.4	6.9
6.5'	98.8	4	4		6.5'	68.7	4.1	4	3.8	6'	25.1	5.9	5	10.4
8'	65.2	5	5		8'	45.4	5.1	5	4.6	8'	14.1	8	6.8	13.9
10'	41.7	6.2	6.2		10'	29	6.4	6.4	5.8	10'	9	10	8.4	17.3
12'	29	7.6	7.6		12'	20.2	7.7	7.6	6.9	12'	6.3	11.9	10.2	20.8

SUMMARY TABLE	
Filename	HL36A20FL930ED010TL3PIN2GMWWB.ies
Test No.	P284136
Lumcat	HL36A20FL930ED010TL3PIN2GMWWB
Lumens	1544 Lm
Watts	19.5 W
LPW	79.2 Lm/W
CCT	3000K
SC (0/90/45)	0.63 / 0.63 / 0.59

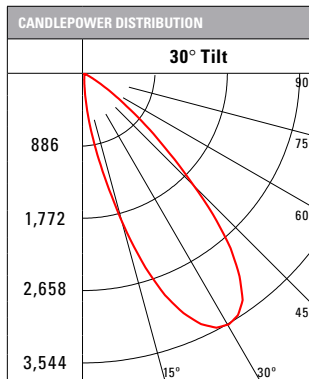
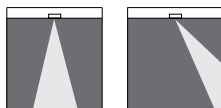

CONE OF LIGHT														
0 deg Aiming Angle Horizontal Illuminance on Floor					30 deg Aiming Angle Horizontal Illuminance on Floor					30 deg Aiming Angle Vertical Illuminance on Wall				
MH	FC	L	W		MH	FC	L	W	CB	D	FC	L	W	CB
4.5'	187	2.8	2.8		4.5'	124.4	2.8	2.8	2.6	3'	82.3	3.1	2.4	5.2
5.5'	125.2	3.4	3.4		5.5'	83.3	3.5	3.4	3.2	4'	46.3	4.2	3.4	6.9
6.5'	89.6	4	4		6.5'	59.6	4.1	4	3.8	6'	20.6	6.3	5	10.4
8'	59.2	5	5		8'	39.4	5.1	5	4.6	8'	11.6	8.5	6.8	13.9
10'	37.9	6.2	6.2		10'	25.2	6.3	6.2	5.8	10'	7.4	10.6	8.6	17.3
12'	26.3	7.4	7.4		12'	17.5	7.6	7.4	6.9	12'	5.1	12.7	10.2	20.8

[View Multipliers](#)

Photometric Data - Wide Flood

[View IES files](#)

SUMMARY TABLE	
Filename	HL36A20WFL930ED010TL3RMW.ies
Test No.	P284187
Lumcat	HL36A20WFL930ED010TL3RMW
Lumens	1609 Lm
Watts	19.5 W
LPW	82.5 Lm/W
CCT	3000K
SC (0/90/45)	0.86 / 0.86 / 0.82

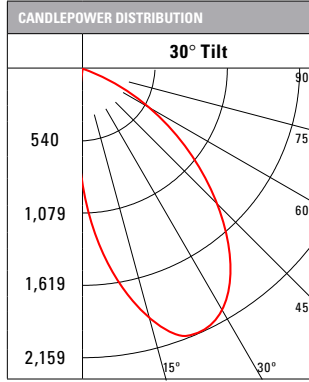
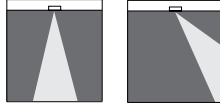

CONE OF LIGHT														
0 deg Aiming Angle Horizontal Illuminance on Floor					30 deg Aiming Angle Horizontal Illuminance on Floor					30 deg Aiming Angle Vertical Illuminance on Wall				
MH	FC	L	W		MH	FC	L	W	CB	D	FC	L	W	CB
4.5'	100.9	3.8	3.8		4.5'	88.1	3.3	3.4	2.6	3'	61.7	3.1	3.2	5.2
5.5'	67.6	4.6	4.6		5.5'	58.9	4	4	3.2	4'	34.7	4.1	4.2	6.9
6.5'	48.4	5.6	5.6		6.5'	42.2	4.8	4.8	3.8	6'	15.4	6.2	6.4	10.4
8'	31.9	6.8	6.8		8'	27.9	5.9	6	4.6	8'	8.7	8.3	8.6	13.9
10'	20.4	8.6	8.6		10'	17.8	7.3	7.4	5.8	10'	5.6	10.4	10.6	17.3
12'	14.2	10.2	10.2		12'	12.4	8.8	9	6.9	12'	3.9	12.6	12.8	20.8

SUMMARY TABLE	
Filename	HL36A20WFL930ED010TL3R2GMW.ies
Test No.	P284186
Lumcat	HL36A20WFL930ED010TL3R2GMW
Lumens	1491 Lm
Watts	19.5 W
LPW	76.5 Lm/W
CCT	3000K
SC (0/90/45)	0.84 / 0.84 / 0.8

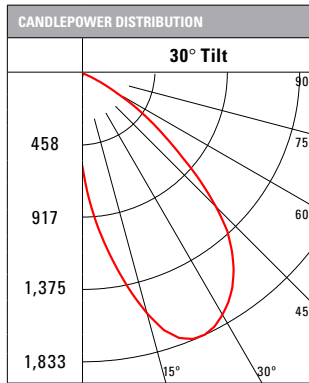
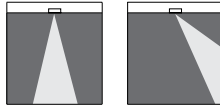

CONE OF LIGHT														
0 deg Aiming Angle Horizontal Illuminance on Floor					30 deg Aiming Angle Horizontal Illuminance on Floor					30 deg Aiming Angle Vertical Illuminance on Wall				
MH	FC	L	W		MH	FC	L	W	CB	D	FC	L	W	CB
4.5'	93.7	3.6	3.6		4.5'	73.4	3.3	3.6	2.6	3'	47.2	3.4	3.2	5.2
5.5'	62.8	4.4	4.4		5.5'	49.1	4.1	4.4	3.2	4'	26.6	4.5	4.2	6.9
6.5'	44.9	5.4	5.4		6.5'	35.2	4.8	5.2	3.8	6'	11.8	6.8	6.4	10.4
8'	29.7	6.6	6.6		8'	23.2	6	6.4	4.6	8'	6.6	9.1	8.6	13.9
10'	19.1	8.2	8.2		10'	14.9	7.5	8	5.8	10'	4.3	11.3	10.8	17.3
12'	13.2	10	10		12'	10.3	9.1	9.6	6.9	12'	3	13.7	13	20.8

SUMMARY TABLE	
Filename	HL36A20WFL930ED010TL3PINMWWB.ies
Test No.	P284185
Lumcat	HL36A20WFL930ED010TL3PINMWWB
Lumens	1490 Lm
Watts	19.5 W
LPW	76.4 Lm/W
CCT	3000K
SC (0/90/45)	0.85 / 0.85 / 0.79

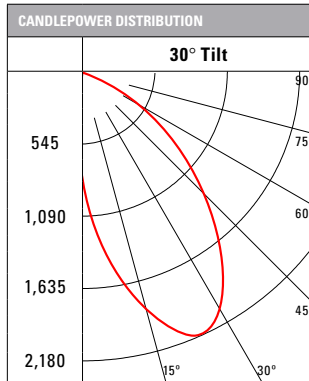
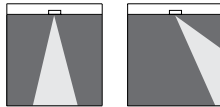

CONE OF LIGHT														
0 deg Aiming Angle Horizontal Illuminance on Floor					30 deg Aiming Angle Horizontal Illuminance on Floor					30 deg Aiming Angle Vertical Illuminance on Wall				
MH	FC	L	W		MH	FC	L	W	CB	D	FC	L	W	CB
4.5'	100.3	3.8	3.8		4.5'	83.7	3.3	3.2	2.6	3'	51.6	3.3	3	5.2
5.5'	67.1	4.6	4.6		5.5'	56.1	4.1	3.8	3.2	4'	29	4.4	4	6.9
6.5'	48.1	5.4	5.4		6.5'	40.1	4.8	4.6	3.8	6'	12.9	6.7	6	10.4
8'	31.7	6.6	6.6		8'	26.5	5.9	5.8	4.6	8'	7.3	8.9	8	13.9
10'	20.3	8.4	8.4		10'	17	7.4	7.2	5.8	10'	4.6	11.2	10	17.3
12'	14.1	10	10		12'	11.8	8.9	8.6	6.9	12'	3.2	13.5	12	20.8

SUMMARY TABLE	
Filename	HL36A20WFL930ED010TL3PIN2GMWWB.ies
Test No.	P284184
Lumcat	HL36A20WFL930ED010TL3PIN2GMWWB
Lumens	1393 Lm
Watts	19.5 W
LPW	71.4 Lm/W
CCT	3000K
SC (0/90/45)	0.82 / 0.82 / 0.78

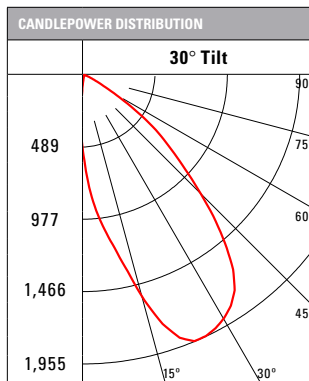
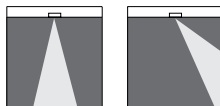

CONE OF LIGHT														
0 deg Aiming Angle Horizontal Illuminance on Floor					30 deg Aiming Angle Horizontal Illuminance on Floor					30 deg Aiming Angle Vertical Illuminance on Wall				
MH	FC	L	W		MH	FC	L	W	CB	D	FC	L	W	CB
4.5'	93.6	3.6	3.6		4.5'	73.6	3.2	3.2	2.6	3'	42.1	3.6	3	5.2
5.5'	62.7	4.4	4.4		5.5'	49.3	4	4	3.2	4'	23.7	4.8	4.2	6.9
6.5'	44.9	5.2	5.2		6.5'	35.3	4.7	4.6	3.8	6'	10.5	7.2	6.2	10.4
8'	29.6	6.4	6.4		8'	23.3	5.7	5.8	4.6	8'	5.9	9.7	8.4	13.9
10'	19	8.2	8.2		10'	14.9	7.2	7.2	5.8	10'	3.8	12.1	10.4	17.3
12'	13.2	9.8	9.8		12'	10.4	8.7	8.6	6.9	12'	2.6	14.5	12.6	20.8

[View Multipliers](#)

Notes and Formulas

- Illuminance values for multiple fixtures are based upon the center two units of a four unit array. Footcandle values are centerline of fixtures and centered between fixtures.
- Illuminance values are cosine corrected initial values with no contribution from inter reflections from other room surfaces. Total illumination may increase from contributions from other surfaces.
- DD=Distance Down from Ceiling.
- Changing fixture spacing will affect illuminance level.

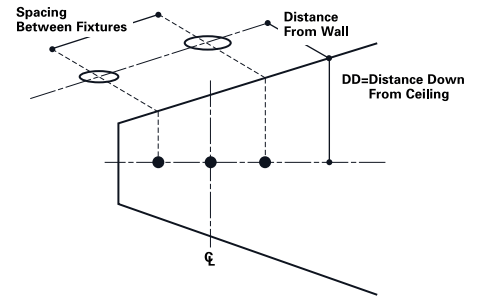

$$\text{New Fc} = \frac{\text{Existing Spacing}}{\text{New Spacing}} \times \text{Average Table Fc Level}$$

For optimal wall washing, space fixtures equal to the distance from the wall.

SUMMARY TABLE	
Filename	HL36A20FL927ED010TL3LWWMW.ies
Test No.	P284435
Lumcat	HL36A20FL927ED010TL3LWWMW
Lumens	1037 Lm
Watts	19.5 W
LPW	53.2 Lm/W
CCT	2700K
SC (0/90/45)	1.09 / 1.01 / 1.15

Single Footcandles 3' from wall (distance from fixture along wall)								
DD	•	1'	2'	3'	4'	5'	6'	
2'	15.8	12.8	7.5	3.8	1.8	0.9	0.4	
3'	14.3	12.2	8	4.6	2.5	1.4	0.8	
4'	10.8	9.5	6.9	4.4	2.7	1.6	0.9	
5'	7.7	7	5.4	3.8	2.5	1.6	1	
6'	5.4	5	4.1	3.1	2.1	1.5	1	
8'	2.8	2.6	2.3	1.9	1.5	1.1	0.8	
10'	1.6	1.5	1.4	1.2	1	0.8	0.6	

Multiple Unit Footcandles 2' from wall (spacing between fixtures)								
•	- 2'-	•	•	- 3'-	•			
42.7	45.7	42.7		36.4	31.8	36.4		
29.8	32.6	29.8		25.1	25.2	25.1		
19	20.7	19		16.1	17.2	16.1		
12.2	13.1	12.2		10.5	11.4	10.5		
8	8.5	8		7.1	7.7	7.1		
3.9	4	3.9		3.5	3.8	3.5		
2.1	2.1	2.1		2	2.1	2		

Multiple Unit Footcandles 3' from wall (spacing between fixtures)								
•	- 2'-	•	•	- 3'-	•			
23.3	25.6	23.3		19.6	20.2	19.6		
22.4	24.3	22.4		19	20.3	19		
17.7	19	17.7		15.2	16.6	15.2		
13.1	13.9	13.1		11.4	12.5	11.4		
9.5	10	9.5		8.4	9.2	8.4		
5.1	5.3	5.1		4.7	5	4.7		
2.9	3	2.9		2.7	2.9	2.7		

SUMMARY TABLE	
Filename	HL36A20FL930ED010TL3LWWMW.ies
Test No.	P284436
Lumcat	HL36A20FL930ED010TL3LWWMW
Lumens	1105 Lm
Watts	19.5 W
LPW	56.7 Lm/W
CCT	3000K
SC (0/90/45)	1.09 / 1.01 / 1.15

Single Footcandles 3' from wall (distance from fixture along wall)								
DD	•	1'	2'	3'	4'	5'	6'	
2'	16.9	13.6	8	4	1.9	0.9	0.5	
3'	15.3	13	8.6	4.9	2.7	1.5	0.8	
4'	11.5	10.1	7.4	4.7	2.8	1.7	1	
5'	8.2	7.4	5.8	4	2.6	1.7	1.1	
6'	5.7	5.3	4.4	3.3	2.3	1.6	1	
8'	3	2.8	2.5	2	1.6	1.2	0.9	
10'	1.7	1.6	1.5	1.3	1.1	0.9	0.7	

Multiple Unit Footcandles 2' from wall (spacing between fixtures)								
•	- 2'-	•	•	- 3'-	•			
45.5	48.7	45.5		38.8	33.8	38.8		
31.8	34.7	31.8		26.8	26.8	26.8		
20.3	22	20.3		17.2	18.4	17.2		
13	13.9	13		11.2	12.2	11.2		
8.5	9.1	8.5		7.5	8.2	7.5		
4.1	4.3	4.1		3.7	4	3.7		
2.2	2.3	2.2		2.1	2.2	2.1		

Multiple Unit Footcandles 3' from wall (spacing between fixtures)								
•	- 2'-	•	•	- 3'-	•			
24.9	27.2	24.9		20.9	21.5	20.9		
23.8	25.9	23.8		20.2	21.7	20.2		
18.8	20.3	18.8		16.2	17.7	16.2		
13.9	14.8	13.9		12.2	13.3	12.2		
10.1	10.7	10.1		9	9.8	9		
5.4	5.6	5.4		5	5.3	5		
3.1	3.2	3.1		2.9	3.1	2.9		

View Multipliers

Photometric Data - Wall Wash

 [View IES files](#)

 [View Multipliers](#)

SUMMARY TABLE	
Filename	HL36A20FL935ED010TL3LWVMMW.ies
Test No.	P284437
Lumcat	HL36A20FL935ED010TL3LWVMMW
Lumens	1166 Lm
Watts	19.5 W
LPW	59.8 Lm/W
CCT	3500K
SC (0/90/45)	1.09 / 1.01 / 1.15

Single Footcandles 3' from wall (distance from fixture along wall)								
DD	•	1'	2'	3'	4'	5'	6'	
2'	17.8	14.4	8.4	4.3	2	1	0.5	
3'	16.1	13.7	9	5.2	2.8	1.6	0.9	
4'	12.1	10.7	7.8	5	3	1.8	1.1	
5'	8.6	7.8	6.1	4.2	2.8	1.8	1.1	
6'	6.1	5.6	4.6	3.4	2.4	1.6	1.1	
8'	3.1	3	2.6	2.2	1.7	1.3	0.9	
10'	1.7	1.7	1.5	1.3	1.1	0.9	0.7	

Multiple Unit Footcandles 2' from wall (spacing between fixtures)								
•	- 2'-	•		•	- 3'-	•		
48	51.4	48		41	35.7	41		
33.5	36.6	33.5		28.2	28.3	28.2		
21.4	23.2	21.4		18.1	19.4	18.1		
13.7	14.7	13.7		11.8	12.9	11.8		
9	9.6	9		7.9	8.7	7.9		
4.3	4.5	4.3		4	4.2	4		
2.4	2.4	2.4		2.2	2.3	2.2		

Multiple Unit Footcandles 3' from wall (spacing between fixtures)								
•	- 2'-	•		•	- 3'-	•		
26.2	28.8	26.2		22.1	22.7	22.1		
25.2	27.4	25.2		21.3	22.9	21.3		
19.9	21.4	19.9		17.1	18.6	17.1		
14.7	15.7	14.7		12.9	14.1	12.9		
10.7	11.3	10.7		9.5	10.3	9.5		
5.7	5.9	5.7		5.3	5.6	5.3		
3.3	3.4	3.3		3.1	3.3	3.1		

SUMMARY TABLE	
Filename	HL36A20FL940ED010TL3LWVMMW.ies
Test No.	P284438
Lumcat	HL36A20FL940ED010TL3LWVMMW
Lumens	1183 Lm
Watts	19.5 W
LPW	60.7 Lm/W
CCT	4000K
SC (0/90/45)	1.09 / 1.01 / 1.15

Single Footcandles 3' from wall (distance from fixture along wall)								
DD	•	1'	2'	3'	4'	5'	6'	
18.1	14.6	8.6	4.3	2.1	1	0.5	0.5	
16.3	13.9	9.2	5.3	2.9	1.6	0.9	0.9	
12.3	10.9	7.9	5	3	1.8	1.1	1.1	
8.8	7.9	6.2	4.3	2.8	1.8	1.1	1.2	
6.1	5.7	4.7	3.5	2.4	1.7	1.1	1.2	
3.2	3	2.6	2.2	1.7	1.3	0.9	1	
1.8	1.7	1.6	1.4	1.1	0.9	0.7	0.8	

Multiple Unit Footcandles 2' from wall (spacing between fixtures)								
•	- 2'-	•		•	- 3'-	•		
48.7	52.2	48.7		41.6	36.2	41.6		
34	37.2	34		28.6	28.7	28.6		
21.7	23.6	21.7		18.4	19.7	18.4		
13.9	14.9	13.9		12	13.1	12		
9.1	9.7	9.1		8	8.8	8		
4.4	4.6	4.4		4	4.3	4		
2.4	2.4	2.4		2.2	2.4	2.2		

Multiple Unit Footcandles 3' from wall (spacing between fixtures)								
•	- 2'-	•		•	- 3'-	•		
26.6	29.2	26.6		22.4	23.1	22.4		
25.5	27.8	25.5		21.6	23.2	21.6		
20.2	21.7	20.2		17.3	18.9	17.3		
14.9	15.9	14.9		13.1	14.3	13.1		
10.8	11.4	10.8		9.6	10.5	9.6		
5.8	6	5.8		5.3	5.7	5.3		
3.3	3.4	3.3		3.1	3.3	3.1		

Color Metric Summary

SUMMARY TABLE - 2700 K

TM-30-15	R _f = 93.1
	R _g = 98.5
CRI/ CIE	R _a = 93.7
	R ₉ = 56.2

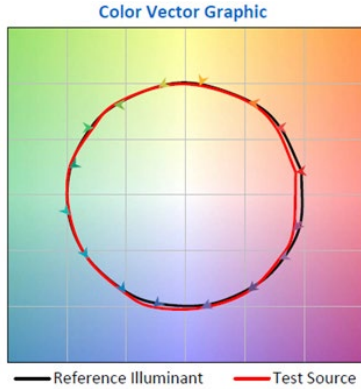
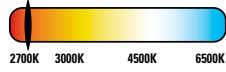

CIE 1931 Chromaticity Diagram and 2015 ANSI 7-Step Quadrangles

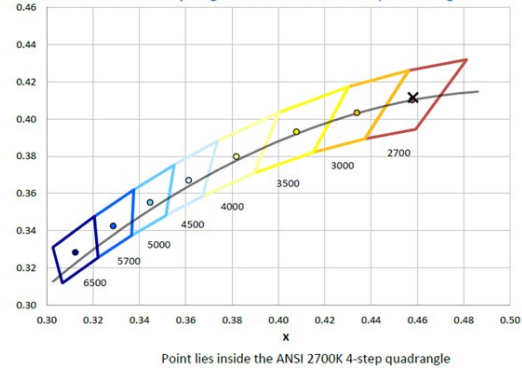

CCT = 2731K
CIE x = 0.4581
CIE y = 0.4115
Duv = 0.0005

SUMMARY TABLE - 3000 K

TM-30-15	R _f = 92.5
	R _g = 98.7
CRI/ CIE	R _a = 93.6
	R ₉ = 56.2

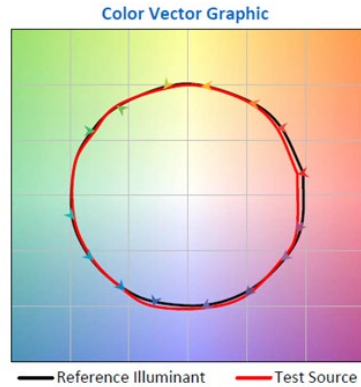
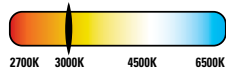

CIE 1931 Chromaticity Diagram and 2015 ANSI 7-Step Quadrangles

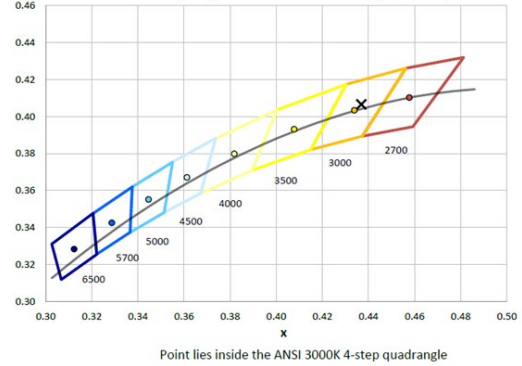

CCT = 3019K
CIE x = 0.4369
CIE y = 0.4065
Duv = 0.0010

SUMMARY TABLE - 3500 K

TM-30-15	R _f = 91.4
	R _g = 98.8
CRI/ CIE	R _a = 92.4
	R ₉ = 54.8

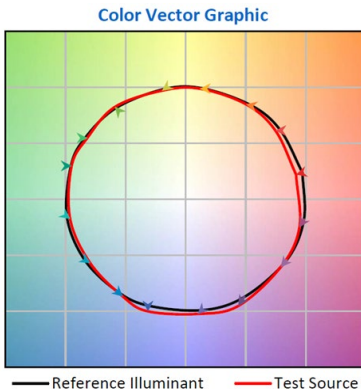
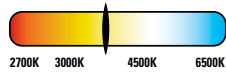

CIE 1931 Chromaticity Diagram and 2015 ANSI 7-Step Quadrangles

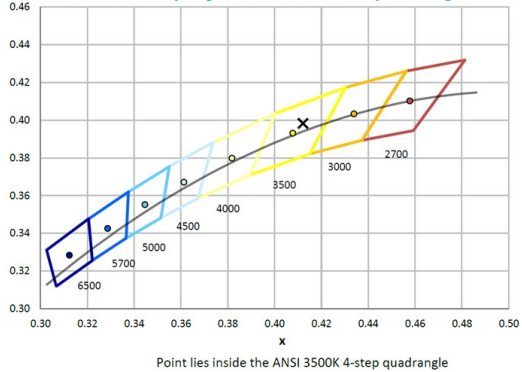

CCT = 3415K
CIE x = 0.4121
CIE y = 0.3982
Duv = 0.0018

SUMMARY TABLE - 4000 K

TM-30-15	R _f = 91.1
	R _g = 99.2
CRI/ CIE	R _a = 93.5
	R ₉ = 62.2

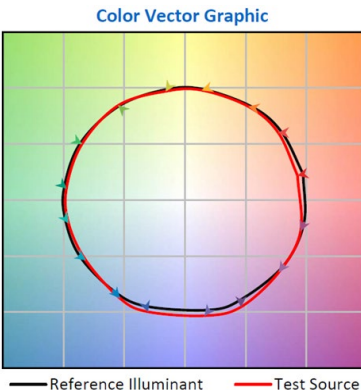
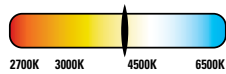

CIE 1931 Chromaticity Diagram and 2015 ANSI 7-Step Quadrangles

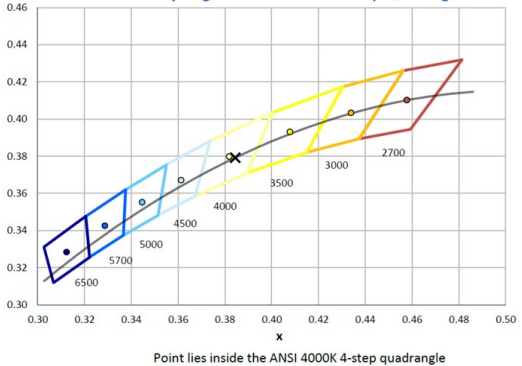

CCT = 3908K
CIE x = 0.3844
CIE y = 0.3791
Duv = -0.0001