

KT-LALEDXXPS-YA-8CSF-VDIM-X

LED LINEAR PENDANT FIXTURE

DESCRIPTION

Linear Architectural LED Fixture with Direct/Indirect Lighting
 Power and Color Selectable | 120-277V Input
 0-10 VDIM with 12V AUX Lifetime

APPLICATION

Indoor Illumination needs for Office, Education, Healthcare, Hospitality and Retail settings with a wide variety of installation options



10 YEAR LIMITED WARRANTY

PRODUCT FEATURES

- Modern architectural linear fixture with an unparalleled blend of flexible performance specs, attractive design, and easy modular linking to meet diverse requirements from general purpose to specification grade applications. Available in 2', 3', 4' and 8' lengths.
- Extruded Aluminum Housing & internal wiring designed for modular tool-free assembly allows installers to quickly and seamlessly link fixtures to create continuous rows of illumination.
- Select between Direct and Direct/Indirect lighting modes to suit lighting needs. (100% down, 70% down/30% up, 50% down/50% up)
- All fixtures are Power & Color Selectable with up to 130 lm/W offers class leading efficiency for maximum energy savings
- Powered by Keystone 0-10V Dimming LED driver with Dim-to-Off & 12V AUX power tap
- Diffused polycarbonate lens provide uniform illumination and lit appearance
- Each Fixture includes a standard 15' aircraft mounting cable kit for suspension mount installations and options for both fixed cable grippers and adjustable cable grippers that slide along with length of the fixture, to allow for flexible ceiling mount locations
- Fixture does NOT include an input power cord. Input power cords sold separately. Need one input power cord per run of connected fixtures (not to exceed total run of 7 fixtures per power cord.) Please see page 9 for details on available power cord options.
- Wide variety of cable mount canopy accessories available (sold separately) for feed and non-feed kits to cover a wide variety of installations needs including J-Box mount, surface/drywall mount, T-Bar Mount, and Masonry Mount
- Optional 32' roll out monolithic lens (sold separately) for a seamless lens on continuous runs. Field installable and can be cut to length as needed
- Optional recessed, wall, and surface mounting kits available (sold separately) add versatility for a wide range of applications
- Optional Smartloop Wireless occupancy sensor end cap to mount KTSL-FC2-12V-SM-PIR
- Compatible with Keystone SmartSafe emergency LED drivers (4' and 8' only)
- UL Certified for dry or damp locations
- LED chip lifetime: L70 >100,000 hrs @ 25°C/77°F ambient fixture temp and wall only. Recessed mount Max of 40C
- Power Factor >0.95, THD:<20%
- Ambient operating temperature: -40°C/-40°F to 50°C/122°F (pessant and wall only. Recessed mount Max of 40C)
- Meets FCC Part 15, Part B, Class A standards for conducted and radiated emissions
- Available in White, Black, and Silver Finishes

PERFORMANCE SPECIFICATIONS OVERVIEW

| Catalog Number | Nominal Size | Preset Wattage | Preset CCT | Lumens | Efficacy | Input Voltage | Dimming | CRI | Lifetime |
|-----------------------------|--------------|----------------|------------|--------|----------|---------------|---------|-----|-----------|
| KT-LALED20PS-2A-8CSF-VDIM-X | 2' | 20W | 5000K | 2,600 | 130 lm/W | 120-277V | 0-10V | >80 | 50,000hrs |
| KT-LALED30PS-3A-8CSF-VDIM-X | 3' | 30W | | 3,900 | | | | | |
| KT-LALED40PS-4A-8CSF-VDIM-X | 4' | 40W | | 5,200 | | | | | |
| KT-LALED80PS-8A-8CSF-VDIM-X | 8' | 80W | | 10,400 | | | | | |

* Fixture Pre-set to highest Wattage & 5000K
 **Color Uniformity: CCT (Correlated Color Temperature) range as per guidelines outlined in ANSI C78.377-2017

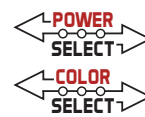

KT-LALEDXXPS-YA-8CSF-VDIM-X

LED LINEAR PENDANT FIXTURE

PERFORMANCE SPECIFICATIONS DETAILED

| Catalog Number | Nominal Size | Selectable Wattage | Selectable CCT | Max Lumens | Nominal Efficacy | Input Voltage | Dimmable | CRI | Lifetime | Housing Color |
|-----------------------------|--------------|--------------------|---|------------|------------------|---------------|----------|-----|------------|---------------|
| KT-LALED20PS-2A-8CSF-VDIM | 2' | 20W / 15W / 12W | 2700K 3000K 3500K 4000K 5000K | 2600 | 130 lm/W | 120-277V | 0-10V | >80 | 50,000 hrs | White |
| KT-LALED20PS-2A-8CSF-VDIM-B | | | | | | | | | | Black |
| KT-LALED20PS-2A-8CSF-VDIM-S | | | | | | | | | | Silver |
| KT-LALED30PS-3A-8CSF-VDIM | 3' | 30W / 23W / 18W | 2700K 3000K 3500K 4000K 5000K | 3900 | 130 lm/W | 120-277V | 0-10V | >80 | 50,000 hrs | White |
| KT-LALED30PS-3A-8CSF-VDIM-B | | | | | | | | | | Black |
| KT-LALED30PS-3A-8CSF-VDIM-S | | | | | | | | | | Silver |
| KT-LALED40PS-4A-8CSF-VDIM | 4' | 40W / 30W / 25W | 2700K 3000K 3500K 4000K 5000K | 5200 | 130 lm/W | 120-277V | 0-10V | >80 | 50,000 hrs | White |
| KT-LALED40PS-4A-8CSF-VDIM-B | | | | | | | | | | Black |
| KT-LALED40PS-4A-8CSF-VDIM-S | | | | | | | | | | Silver |
| KT-LALED80PS-8A-8CSF-VDIM | 8' | 80W / 60W / 50W | 2700K 3000K 3500K 4000K 5000K | 10400 | 130 lm/W | 120-277V | 0-10V | >80 | 50,000 hrs | White |
| KT-LALED80PS-8A-8CSF-VDIM-B | | | | | | | | | | Black |
| KT-LALED80PS-8A-8CSF-VDIM-S | | | | | | | | | | Silver |

EASY LINKABLE FUNCTION

- These fixtures are designed to be easily linkable / daisychained in any variety of lengths, so long as the total connected load (per power feed) does not exceed the following conditions:
 - 7 fixtures max
 - Total connected load is <420W at 120V and <960W at 277V

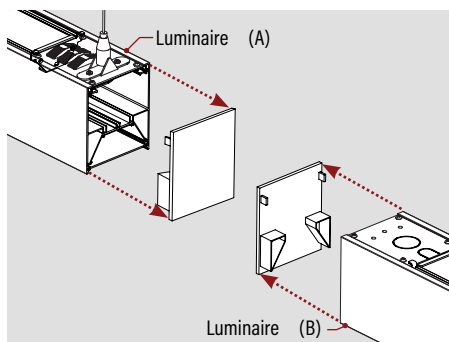

Step 1. Remove End Caps and open the topside of the fixture

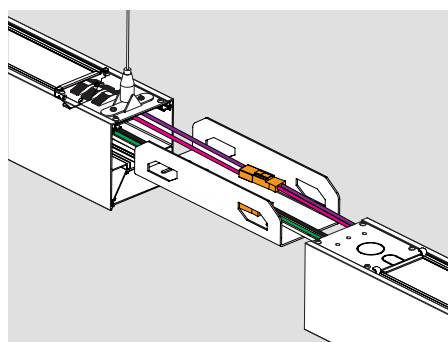

Step 2. Insert Linking Bracket, Connect wiring via included quick connects, Slide Fixture together, and fasten bracket with included buckles

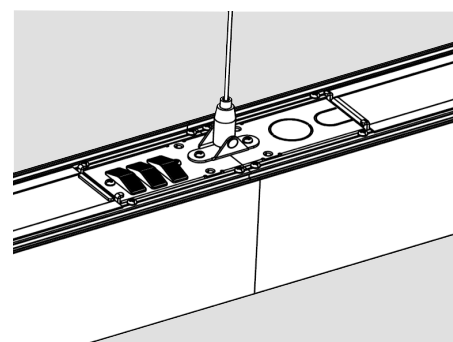

Step 3. Install suitable suspension hardware ((1) fixed aircraft cable gripper bridged across the fixture seam is recommended)

Single Direction

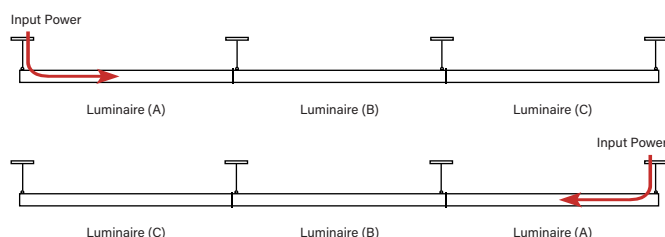

Multi-Direction

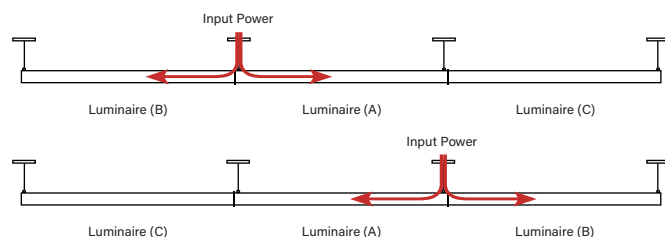

* For Multi-Direction wiring requires use of wiring harness accessory (KT-LALED-WH-MD-KIT).



KT-LALEDXXPS-YA-8CSF-VDIM-X

LED LINEAR PENDANT FIXTURE

WHATS INCLUDED

- Each Fixture Comes with the following
 - (1) Fixture Body
 - (1) Standard Aircraft Cable Hanging Kit (Use as desired)
 - (2) 15' aircraft cables with tapped base coupler & hardware (for surface mount)
 - (2) 15' aircraft cables with looped end
 - (2) Fixed aircraft cable grippers
 - (2) Adjustable "Y" cable grippers
 - (1) Fixture Linking Bracket (Not used for single fixture installs)

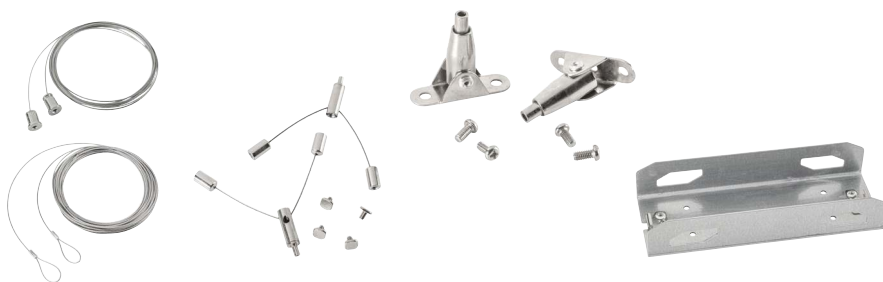

Hanging using fixed aircraft cable grippers

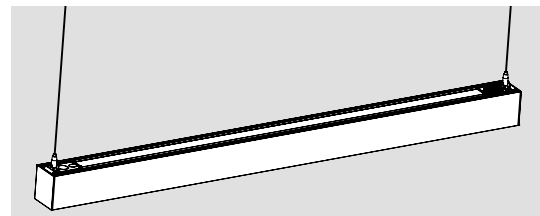

Hanging using adjustable "Y" cable grippers

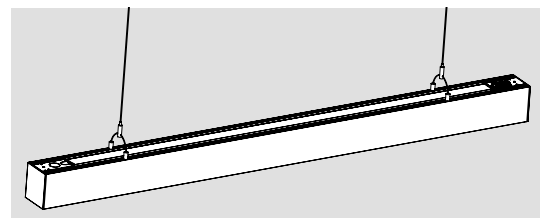

SELECTABLE SETTINGS

- Keystone Power Select Technology: Select between 3 different wattage settings per fixture
- Keystone Color Select Technology: Select between 5 different CCT settings per fixture (2700K, 3000K, 3500K, 4000K, 5000K)
- Select Lighting Mode: 100% down, 70% down/30% up, 50% down/50% up

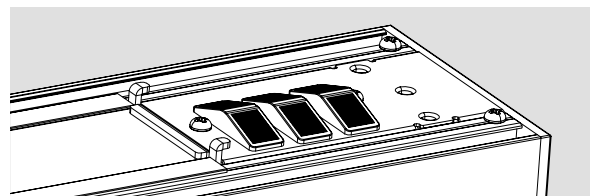

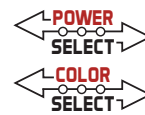

KT-LALEDXXPS-YA-8CSF-VDIM-X

LED LINEAR PENDANT FIXTURE

DETAILED PRODUCT SPECIFICATIONS & PHOTOMETRICS

NOMINAL VALUES PER FOOT

| Selectable Wattage | Lumens | | | | | |
|--------------------|-----------------------------|----|-----------------------------|-----|-----------------------------|-----|
| | Lighting Mode | | | | | |
| | 100% Downlight / 0% Uplight | | 70% Downlight / 30% Uplight | | 50% Downlight / 50% Uplight | |
| | Down | Up | Down | Up | Down | Up |
| 10W | 1300 | 0 | 910 | 390 | 650 | 650 |
| 7.5W | 975 | 0 | 683 | 293 | 488 | 488 |
| 6.25W | 813 | 0 | 569 | 244 | 406 | 406 |

| Catalog Number | | KT-LALED20PS-2A-8CSF-VDIM-X | | | | | | | | | | | | | | | | |
|--------------------|---------------|-----------------------------|-------|-------|-------|-------|-------|-------|-------|-------|-------|-------|-------|-------|-------|-------|------|------|
| Nominal Size | | 2' | | | | | | | | | | | | | | | | |
| Selectable Wattage | | 20W | | | | | 15W | | | | | 12W | | | | | | |
| Selectable CCT | | 2700K | 3000K | 3500K | 4000K | 5000K | 2700K | 3000K | 3500K | 4000K | 5000K | 2700K | 3000K | 3500K | 4000K | 5000K | | |
| Lumens | Lighting Mode | 100% Downlight / 0% Uplight | Down | 2400 | 2500 | 2620 | 2660 | 2640 | 1800 | 1875 | 1965 | 1995 | 1980 | 1440 | 1500 | 1572 | 1596 | 1584 |
| | | | Up | 0 | 0 | 0 | 0 | 0 | 0 | 0 | 0 | 0 | 0 | 0 | 0 | 0 | 0 | 0 |
| | | 70% Downlight / 30% Uplight | Down | 1680 | 1750 | 1834 | 1862 | 1848 | 1260 | 1313 | 1376 | 1397 | 1386 | 1008 | 1050 | 1100 | 1117 | 1109 |
| | | | Up | 720 | 750 | 786 | 798 | 792 | 540 | 563 | 590 | 599 | 594 | 432 | 450 | 472 | 479 | 475 |
| | | 50% Downlight / 50% Uplight | Down | 1200 | 1250 | 1310 | 1330 | 1320 | 900 | 938 | 983 | 998 | 990 | 720 | 750 | 786 | 798 | 792 |
| | | | Up | 1200 | 1250 | 1310 | 1330 | 1320 | 900 | 938 | 983 | 998 | 990 | 720 | 750 | 786 | 798 | 792 |
| Efficacy | | 120 | 125 | 131 | 133 | 132 | 120 | 125 | 131 | 133 | 132 | 120 | 125 | 131 | 133 | 132 | | |

ZONAL LUMEN SUMMARY

| Down/Up | 50/50 | | | | | | 70/30 | | | | | | 100/0 | | | | | |
|-------------|-------|-------|-------|-------|--------|-------|-------|-------|-------|-------|--------|-------|-------|-------|-------|------|--------|-------|
| Zone | 0-30 | 0-40 | 0-60 | 0-90 | 90-180 | 0-180 | 0-30 | 0-40 | 0-60 | 0-90 | 90-180 | 0-180 | 0-30 | 0-40 | 0-60 | 0-90 | 90-180 | 0-180 |
| Lumens | 418 | 677 | 1167 | 1452 | 1409 | 2861 | 586 | 947 | 1632 | 2032 | 846 | 2878 | 801 | 1296 | 2238 | 2794 | 0 | 2794 |
| % Luminaire | 14.6% | 23.7% | 40.8% | 50.8% | 49.2% | 100% | 20.4% | 32.9% | 56.7% | 70.6% | 29.4% | 100% | 28.7% | 46.4% | 80.1% | 100% | 0.0% | 100% |

ISOCANDELA PLOT

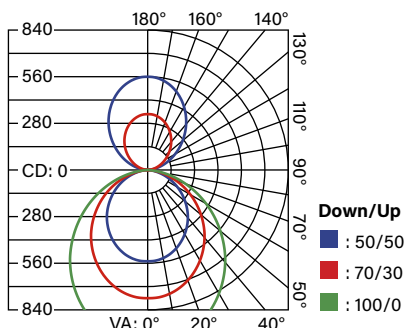

CANDELA TABLE (50/50)

| Vertical Angle | Candela |
|----------------|---------|
| 0 | 550 |
| 5 | 549 |
| 15 | 524 |
| 25 | 477 |
| 35 | 413 |
| 45 | 337 |

CANDELA TABLE (70/30)

| Vertical Angle | Candela |
|----------------|---------|
| 0 | 771 |
| 5 | 768 |
| 15 | 733 |
| 25 | 667 |
| 35 | 577 |
| 45 | 471 |

CANDELA TABLE (100/0)

| Vertical Angle | Candela |
|----------------|---------|
| 0 | 1054 |
| 5 | 1051 |
| 15 | 1001 |
| 25 | 910 |
| 35 | 788 |
| 45 | 643 |

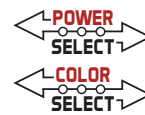

KT-LALEDXXPS-YA-8CSF-VDIM-X

LED LINEAR PENDANT FIXTURE

DETAILED PRODUCT SPECIFICATIONS & PHOTOMETRICS (continued)

| Catalog Number | | | KT-LALED30PS-3A-8CSF-VDIM-X | | | | | | | | | | | | | | | |
|--------------------|-----------------------------|-----------------------------|-----------------------------|-------|-------|-------|-------|-------|-------|-------|-------|-------|-------|-------|-------|-------|-------|------|
| Nominal Size | | | 3' | | | | | | | | | | | | | | | |
| Selectable Wattage | | | 30W | | | | | 23W | | | | | 18W | | | | | |
| Selectable CCT | | | 2700K | 3000K | 3500K | 4000K | 5000K | 2700K | 3000K | 3500K | 4000K | 5000K | 2700K | 3000K | 3500K | 4000K | 5000K | |
| Lumens | Lighting Mode | 100% Downlight / 0% Uplight | Down | 3600 | 3750 | 3930 | 3990 | 3960 | 2760 | 2875 | 3013 | 3059 | 3036 | 2160 | 2250 | 2358 | 2394 | 2376 |
| | | | Up | 0 | 0 | 0 | 0 | 0 | 0 | 0 | 0 | 0 | 0 | 0 | 0 | 0 | 0 | 0 |
| | 70% Downlight / 30% Uplight | Down | 2520 | 2625 | 2751 | 2793 | 2772 | 1932 | 2013 | 2109 | 2141 | 2125 | 1512 | 1575 | 1651 | 1676 | 1663 | |
| | | Up | 1080 | 1125 | 1179 | 1197 | 1188 | 828 | 863 | 904 | 918 | 911 | 648 | 675 | 707 | 718 | 713 | |
| | 50% Downlight / 50% Uplight | Down | 1800 | 1875 | 1965 | 1995 | 1980 | 1380 | 1438 | 1507 | 1530 | 1518 | 1080 | 1125 | 1179 | 1197 | 1188 | |
| | | Up | 1800 | 1875 | 1965 | 1995 | 1980 | 1380 | 1438 | 1507 | 1530 | 1518 | 1080 | 1125 | 1179 | 1197 | 1188 | |
| Efficacy | | | 120 | 125 | 131 | 133 | 132 | 120 | 125 | 131 | 133 | 132 | 120 | 125 | 131 | 133 | 132 | |

ZONAL LUMEN SUMMARY

| Down/Up | 50/50 | | | | | | 70/30 | | | | | | 100/0 | | | | | |
|-------------|-------|-------|-------|-------|--------|-------|-------|-------|-------|-------|--------|-------|-------|-------|-------|------|--------|-------|
| Zone | 0-30 | 0-40 | 0-60 | 0-90 | 90-180 | 0-180 | 0-30 | 0-40 | 0-60 | 0-90 | 90-180 | 0-180 | 0-30 | 0-40 | 0-60 | 0-90 | 90-180 | 0-180 |
| Lumens | 626 | 1010 | 1736 | 2156 | 2112 | 4268 | 877 | 1415 | 2431 | 3019 | 1272 | 4291 | 1196 | 1932 | 3327 | 4144 | 0 | 4144 |
| % Luminaire | 14.7% | 23.7% | 40.7% | 50.5% | 49.5% | 100% | 20.4% | 33.0% | 56.7% | 70.4% | 29.6% | 100% | 28.9% | 46.6% | 80.3% | 100% | 0.0% | 100% |

ISOCANDELA PLOT

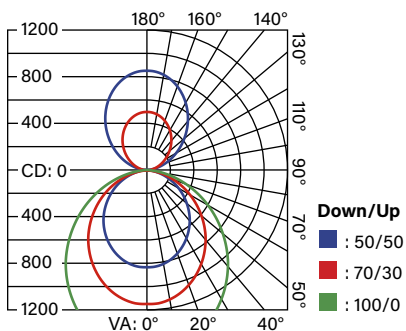

CANDELA TABLE (50/50)

| Vertical Angle | Candela |
|----------------|---------|
| 0 | 825 |
| 5 | 824 |
| 15 | 786 |
| 25 | 713 |
| 35 | 615 |
| 45 | 500 |

CANDELA TABLE (70/30)

| Vertical Angle | Candela |
|----------------|---------|
| 0 | 1156 |
| 5 | 1155 |
| 15 | 1101 |
| 25 | 998 |
| 35 | 861 |
| 45 | 699 |

CANDELA TABLE (100/0)

| Vertical Angle | Candela |
|----------------|---------|
| 0 | 1577 |
| 5 | 1574 |
| 15 | 1499 |
| 25 | 1359 |
| 35 | 1172 |
| 45 | 953 |



KT-LALEDXXPS-YA-8CSF-VDIM-X

LED LINEAR PENDANT FIXTURE

DETAILED PRODUCT SPECIFICATIONS & PHOTOMETRICS (continued)

| Catalog Number | | | KT-LALED40PS-4A-8CSF-VDIM-X | | | | | | | | | | | | | | | |
|--------------------|-----------------------------|-----------------------------|-----------------------------|-------|-------|-------|-------|-------|-------|-------|-------|-------|-------|-------|-------|-------|-------|------|
| Nominal Size | | | 4' | | | | | | | | | | | | | | | |
| Selectable Wattage | | | 40W | | | | | 30W | | | | | 25W | | | | | |
| Selectable CCT | | | 2700K | 3000K | 3500K | 4000K | 5000K | 2700K | 3000K | 3500K | 4000K | 5000K | 2700K | 3000K | 3500K | 4000K | 5000K | |
| Lumens | Lighting Mode | 100% Downlight / 0% Uplight | Down | 5200 | 5200 | 5240 | 5320 | 5280 | 3900 | 3900 | 3930 | 3990 | 3960 | 3250 | 3250 | 3275 | 3325 | 3300 |
| | | | Up | 0 | 0 | 0 | 0 | 0 | 0 | 0 | 0 | 0 | 0 | 0 | 0 | 0 | 0 | 0 |
| | 70% Downlight / 30% Uplight | Down | 3640 | 3640 | 3668 | 3724 | 3696 | 2730 | 2730 | 2751 | 2793 | 2772 | 2275 | 2275 | 2293 | 2328 | 2310 | |
| | | Up | 1560 | 1560 | 1572 | 1596 | 1584 | 1170 | 1170 | 1179 | 1197 | 1188 | 975 | 975 | 983 | 998 | 990 | |
| | 50% Downlight / 50% Uplight | Down | 2600 | 2600 | 2620 | 2660 | 2640 | 1950 | 1950 | 1965 | 1995 | 1980 | 1625 | 1625 | 1638 | 1663 | 1650 | |
| | | Up | 2600 | 2600 | 2620 | 2660 | 2640 | 1950 | 1950 | 1965 | 1995 | 1980 | 1625 | 1625 | 1638 | 1663 | 1650 | |
| Efficacy | | | 130 | 130 | 131 | 133 | 132 | 130 | 130 | 131 | 132 | 132 | 130 | 130 | 131 | 133 | 132 | |

ZONAL LUMEN SUMMARY

| Down/Up | 50/50 | | | | | | 70/30 | | | | | | 100/0 | | | | | |
|-------------|-------|-------|-------|-------|--------|-------|-------|-------|-------|-------|--------|-------|-------|-------|-------|------|--------|-------|
| Zone | 0-30 | 0-40 | 0-60 | 0-90 | 90-180 | 0-180 | 0-30 | 0-40 | 0-60 | 0-90 | 90-180 | 0-180 | 0-30 | 0-40 | 0-60 | 0-90 | 90-180 | 0-180 |
| Lumens | 817 | 1320 | 2275 | 2831 | 2821 | 5652 | 1144 | 1850 | 3187 | 3967 | 1694 | 5662 | 1579 | 2552 | 4396 | 5469 | 0 | 5469 |
| % Luminaire | 14.4% | 23.4% | 40.2% | 50.1% | 49.9% | 100% | 20.2% | 32.7% | 56.3% | 70.1% | 29.9% | 100% | 28.9% | 46.7% | 80.4% | 100% | 0.0% | 100% |

ISOCANDELA PLOT

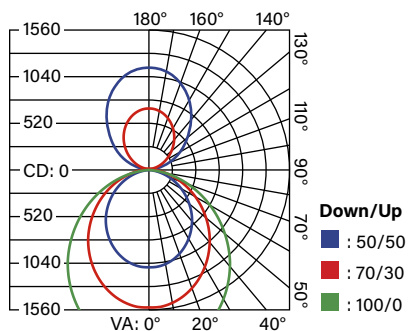

CANDELA TABLE (50/50)

| Vertical Angle | Candela |
|----------------|---------|
| 0 | 1074 |
| 5 | 1074 |
| 15 | 1025 |
| 25 | 932 |
| 35 | 806 |
| 45 | 656 |

CANDELA TABLE (70/30)

| Vertical Angle | Candela |
|----------------|---------|
| 0 | 1506 |
| 5 | 1506 |
| 15 | 1436 |
| 25 | 1305 |
| 35 | 1129 |
| 45 | 919 |

CANDELA TABLE (100/0)

| Vertical Angle | Candela |
|----------------|---------|
| 0 | 2080 |
| 5 | 2079 |
| 15 | 1982 |
| 25 | 1801 |
| 35 | 1557 |
| 45 | 1268 |

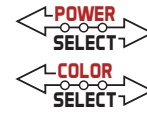

KT-LALEDXXPS-YA-8CSF-VDIM-X

LED LINEAR PENDANT FIXTURE

DETAILED PRODUCT SPECIFICATIONS & PHOTOMETRICS (continued)

| Catalog Number | | KT-LALED80PS-8A-8CSF-VDIM-X | | | | | | | | | | | | | | | |
|--------------------|-----------------------------|-----------------------------|-------|-------|-------|-------|-------|-------|-------|-------|-------|-------|-------|-------|-------|-------|------|
| Nominal Size | | 8' | | | | | | | | | | | | | | | |
| Selectable Wattage | | 80W | | | | | 60W | | | | | 50W | | | | | |
| Selectable CCT | | 2700K | 3000K | 3500K | 4000K | 5000K | 2700K | 3000K | 3500K | 4000K | 5000K | 2700K | 3000K | 3500K | 4000K | 5000K | |
| Lumens | 100% Downlight / 0% Uplight | Down | 10400 | 10400 | 10480 | 10640 | 10560 | 7800 | 7800 | 7860 | 7980 | 7920 | 6500 | 6500 | 6550 | 6650 | 660 |
| | | Up | 0 | 0 | 0 | 0 | 0 | 0 | 0 | 0 | 0 | 0 | 0 | 0 | 0 | 0 | 0 |
| | 70% Downlight / 30% Uplight | Down | 7280 | 7280 | 7336 | 7448 | 7392 | 5460 | 5460 | 5502 | 5586 | 5544 | 4550 | 4550 | 4585 | 4655 | 4620 |
| | | Up | 3120 | 3120 | 3144 | 3192 | 3168 | 2340 | 2340 | 2358 | 2394 | 2376 | 1950 | 1950 | 1965 | 1995 | 1980 |
| | 50% Downlight / 50% Uplight | Down | 5200 | 5200 | 5240 | 5320 | 5280 | 3900 | 3900 | 3930 | 3990 | 3960 | 3250 | 3250 | 3275 | 3325 | 3300 |
| | | Up | 5200 | 5200 | 5240 | 5320 | 5280 | 3900 | 3900 | 3930 | 3990 | 3960 | 3250 | 3250 | 3275 | 3325 | 3300 |
| Efficacy | | 130 | 130 | 131 | 133 | 132 | 130 | 130 | 131 | 133 | 132 | 130 | 130 | 131 | 133 | 132 | |

ZONAL LUMEN SUMMARY

| Down/Up | 50/50 | | | | | | 70/30 | | | | | | 100/0 | | | | | |
|-------------|-------|-------|-------|-------|--------|-------|-------|-------|-------|-------|--------|-------|-------|-------|-------|-------|--------|-------|
| Zone | 0-30 | 0-40 | 0-60 | 0-90 | 90-180 | 0-180 | 0-30 | 0-40 | 0-60 | 0-90 | 90-180 | 0-180 | 0-30 | 0-40 | 0-60 | 0-90 | 90-180 | 0-180 |
| Lumens | 1633 | 2640 | 4549 | 5662 | 5641 | 11304 | 2289 | 3700 | 6374 | 7934 | 3389 | 11323 | 3158 | 5104 | 8791 | 10938 | 0 | 10938 |
| % Luminaire | 14.4% | 23.4% | 40.2% | 50.1% | 49.9% | 100% | 20.2% | 32.7% | 56.3% | 70.1% | 29.9% | 100% | 28.9% | 46.7% | 80.4% | 100% | 0.0% | 100% |

ISOCANDELA PLOT

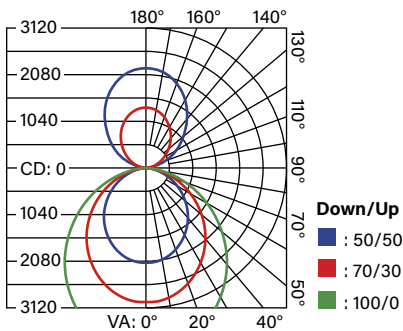

CANDELA TABLE (50/50)

| Vertical Angle | Candela |
|----------------|---------|
| 0 | 2148 |
| 5 | 2148 |
| 15 | 2050 |
| 25 | 1863 |
| 35 | 1613 |
| 45 | 1313 |

CANDELA TABLE (70/30)

| Vertical Angle | Candela |
|----------------|---------|
| 0 | 3012 |
| 5 | 3012 |
| 15 | 2872 |
| 25 | 2610 |
| 35 | 2259 |
| 45 | 1838 |

CANDELA TABLE (100/0)

| Vertical Angle | Candela |
|----------------|---------|
| 0 | 4159 |
| 5 | 4159 |
| 15 | 3963 |
| 25 | 3601 |
| 35 | 3114 |
| 45 | 2535 |

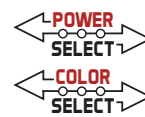

KT-LALEDXXPS-YA-8CSF-VDIM-X

LED LINEAR PENDANT FIXTURE

PHYSICAL SPECIFICATIONS

KT-LALED20PS-2A-8CSF-VDIM-X

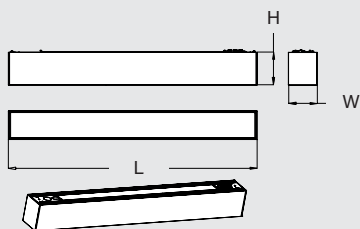

KT-LALED30PS-3A-8CSF-VDIM-X

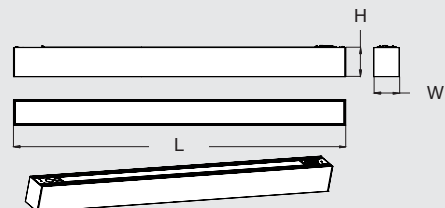

KT-LALED40PS-4A-8CSF-VDIM-X

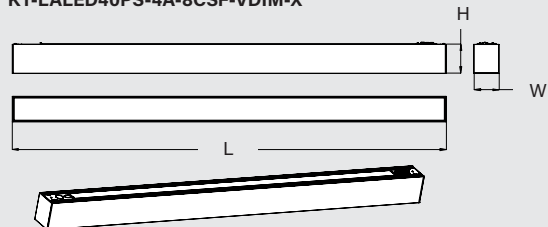

KT-LALED80PS-8A-8CSF-VDIM-X

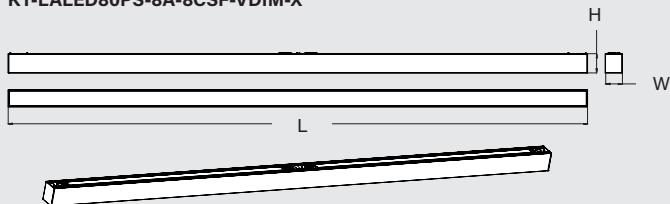

KT-LALED20PS-2A-8CSF-VDIM-X

| | |
|------------|--------|
| L (Length) | 23.86" |
| H (Height) | 3.15" |
| W (Width) | 2.76" |

KT-LALED30PS-3A-8CSF-VDIM-X

| | |
|------------|--------|
| L (Length) | 35.67" |
| H (Height) | 3.15" |
| W (Width) | 2.76" |

KT-LALED40PS-4A-8CSF-VDIM-X

| | |
|------------|--------|
| L (Length) | 47.48" |
| H (Height) | 3.15" |
| W (Width) | 2.76" |

KT-LALED80PS-8A-8CSF-VDIM-X

| | |
|------------|--------|
| L (Length) | 94.72" |
| H (Height) | 3.15" |
| W (Width) | 2.76" |



KT-LALEDXXPS-YA-8CSF-VDIM-X

LED LINEAR PENDANT FIXTURE

PENDANT MOUNT CORE INSTALLATION ACCESSORIES (sold separately)

| Catalog Number | Description | Color | UPC | Easy Code |
|-----------------------------|--|--------|--------------|-----------|
| Round Canopy Kits | | | | |
| KT-LALED-5CC-1-F-KIT | Canopy Cover Feed Kit, J-Box Mount 5" Circular Includes (1) 15' aircraft cable with 2 piece cable coupler, (1) 5" power feed circular canopy, (1) Crossbar w/ 1/4-20 screw, (1) 18/5 SJT sized strain relief, (5) cable ties, (NO POWER CORD INCLUDED) | White | 843654104362 | NMY-61 |
| KT-LALED-5CC-1-F-KIT-B | | Black | 843654161563 | FYY-15 |
| KT-LALED-5CC-1-F-KIT-S | | Silver | 843654169903 | ISY-29 |
| KT-LALED-5CC-1-NF-KIT | Canopy Cover Non-Feed Kit, J-Box / Stud Mount 5" Circular Includes (1) 15' aircraft cable with 2 piece cable coupler, (1) 5" non-feed circular canopy, (1) Crossbar w/ 1/4-20 screw | White | 843654104461 | TFG-31 |
| KT-LALED-5CC-1-NF-KIT-B | | Black | 843654161570 | BSI-54 |
| KT-LALED-5CC-1-NF-KIT-S* | | Silver | 843654169910 | GEA-29 |
| KT-LALED-2CC-1-NF-KIT | Canopy Cover Non-Feed Kit, Drywall / Stud Mount 2" Circular Includes (1) 15' aircraft cable with cable coupler, (1) 2" non-feed circular canopy, (1) 1/4-20 Toggle Bolt Assembly, (1) 1/4-20 Lag Screw | White | 843654104546 | RZF-29 |
| KT-LALED-2CC-1-NF-KIT-B | | Black | 843654161587 | YCO-17 |
| KT-LALED-2CC-1-NF-KIT-S* | | Silver | 843654169927 | XUM-99 |
| KT-LALED-2CC-2-NF-KIT | Canopy Cover Non-Feed Kit, T-Bar Mount 2" Circular Includes (1) 15' aircraft cable with 2 piece cable coupler, (1) 2" non-feed circular canopy, (1) Drop Ceiling Clip / Stud | White | 843654104553 | UOM-12 |
| KT-LALED-2CC-2-NF-KIT-B | | Black | 843654161594 | LQM-47 |
| KT-LALED-2CC-2-NF-KIT-S* | | Silver | 843654169934 | XUG-00 |
| KT-LALED-5CC-2-NF-KIT | Canopy Cover Non-Feed Kit, T-Bar Mount 5" Circular Includes (1) 15' aircraft cable with 2 piece cable coupler, (1) 5" non-feed circular canopy, (1) Drop Ceiling Clip / Stud | White | 843654104560 | YCM-01 |
| KT-LALED-5CC-2-NF-KIT-B | | Black | 843654161600 | CMN-24 |
| KT-LALED-5CC-2-NF-KIT-S* | | Silver | 843654169941 | QEZ-28 |
| KT-LALED-2CC-3-NF-KIT | Canopy Cover Non-Feed Kit, Masonry Mount 2" Circular Includes (1) 15' aircraft cable with 2 piece cable coupler, (1) 2" non-feed circular canopy, (1) 1/4-20 Stud (LAG SHIELD NOT INCLUDED) | White | 843654104577 | DSO-60 |
| KT-LALED-2CC-3-NF-KIT-B | | Black | 843654161617 | GWC-30 |
| KT-LALED-2CC-3-NF-KIT-S* | | Silver | 843654169958 | YKW-31 |
| KT-LALED-CC-UNV-NF-KIT /A | Universal canopy cover Non-Feed kit with included hardware J-box, Stud, T-Bar, Drywall, and Masonry mounts. Separate 2" and 5" circular covers, with 2 piece and 1 piece couplers for covers. | White | 843654161921 | EGC-85 |
| KT-LALED-CC-UNV-NF-KIT-B /A | | Black | 843654161945 | DAT-49 |
| KT-LALED-CC-UNV-NF-KIT-S /A | | Silver | 843654170060 | FFW-86 |

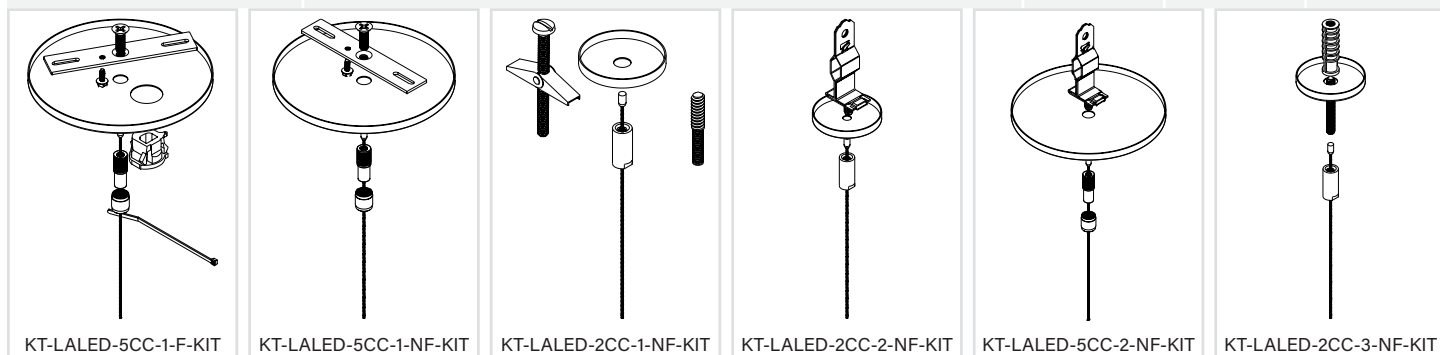

*Special Order Only: Please Contact Keystone for Availability

(Core Installation Accessories continued on next page)

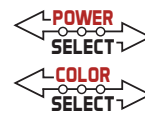

KT-LALEDXXPS-YA-8CSF-VDIM-X

LED LINEAR PENDANT FIXTURE

PENDANT MOUNT CORE INSTALLATION ACCESSORIES (continued)

| Catalog Number | Description | Color | UPC | Easy Code |
|-----------------------------|--|--------|--------------|-----------|
| Square Canopy Kits | | | | |
| KT-LALED-5SC-1-F-KIT | Canopy Cover Feed Kit, J-Box Mount 5" Square Includes (1) 15' aircraft cable with 2 piece cable coupler, (1) 5" power feed square canopy, (1) Crossbar w/ 1/4-20 screw, (1) 18/5 SJT sized strain relief, (5) cable ties, (NO POWER CORD INCLUDED) | White | 843654104584 | KVV-92 |
| KT-LALED-5SC-1-F-KIT-B | | Black | 843654161624 | GPH-64 |
| KT-LALED-5SC-1-F-KIT-S | | Silver | 843654169965 | VQB-17 |
| KT-LALED-5SC-1-NF-KIT | Canopy Cover Non-Feed Kit, J-Box / Stud Mount 5" Square Includes (1) 15' aircraft cable with 2 piece cable coupler, (1) 5" non-feed square canopy, (1) Crossbar w/ 1/4-20 screw | White | 843654104591 | ZTR-83 |
| KT-LALED-5SC-1-NF-KIT-B | | Black | 843654161631 | GBV-15 |
| KT-LALED-5SC-1-NF-KIT-S* | | Silver | 843654169972 | SIP-21 |
| KT-LALED-2SC-1-NF-KIT | Canopy Cover Non-Feed Kit, Drywall / Stud Mount 2" Square Includes (1) 15' aircraft cable with 2 piece cable coupler, (1) 2" non-feed square canopy, (1) 1/4-20 Toggle Bolt Assembly, (1) 1/4-20 Lag Screw | White | 843654104607 | NMB-51 |
| KT-LALED-2SC-1-NF-KIT-B | | Black | 843654161648 | EKF-16 |
| KT-LALED-2SC-1-NF-KIT-S* | | Silver | 843654169989 | LUI-91 |
| KT-LALED-2SC-2-NF-KIT | Canopy Cover Non-Feed Kit, T-Bar Mount 2" Square Includes (1) 15' aircraft cable with 2 piece cable coupler, (1) 2" non-feed square canopy, (1) Drop Ceiling Clip / Stud | White | 843654104683 | YJL-51 |
| KT-LALED-2SC-2-NF-KIT-B | | Black | 843654161655 | TOK-32 |
| KT-LALED-2SC-2-NF-KIT-S* | | Silver | 843654169996 | GZW-96 |
| KT-LALED-5SC-2-NF-KIT | Canopy Cover Non-Feed Kit, T-Bar Mount 5" Square Includes (1) 15' aircraft cable with 2 piece cable coupler, (1) 5" non-feed square canopy, (1) Drop Ceiling Clip / Stud | White | 843654104874 | HZZ-53 |
| KT-LALED-5SC-2-NF-KIT-B | | Black | 843654161662 | VSD-51 |
| KT-LALED-5SC-2-NF-KIT-S* | | Silver | 843654170008 | KGB-80 |
| KT-LALED-2SC-3-NF-KIT | Canopy Cover Non-Feed Kit, Masonry Mount 2" Square Includes (1) 15' aircraft cable with 2 piece cable coupler, (1) 2" non-feed square canopy, (1) 1/4-20 Stud (LAG SHIELD NOT INCLUDED) | White | 843654105055 | AHB-20 |
| KT-LALED-2SC-3-NF-KIT-B | | Black | 843654161679 | NBH-45 |
| KT-LALED-2SC-3-NF-KIT-S* | | Silver | 843654170015 | ILM-85 |
| KT-LALED-SC-UNV-NF-KIT /A | Universal canopy cover Non-Feed kit with included hardware J-Box, Stud, T-Bar, Drywall, and Masonry mounts. Separate 2" & 5" square covers, with 2 piece and 1 piece couplers for covers. No Aircraft Cable included (re-use aircraft cable supplied with each fixture.) | White | 843654161938 | OHV-56 |
| KT-LALED-SC-UNV-NF-KIT-B /A | | Black | 843654161952 | PNP-83 |
| KT-LALED-SC-UNV-NF-KIT-S /A | | Silver | 843654170077 | IAU-56 |

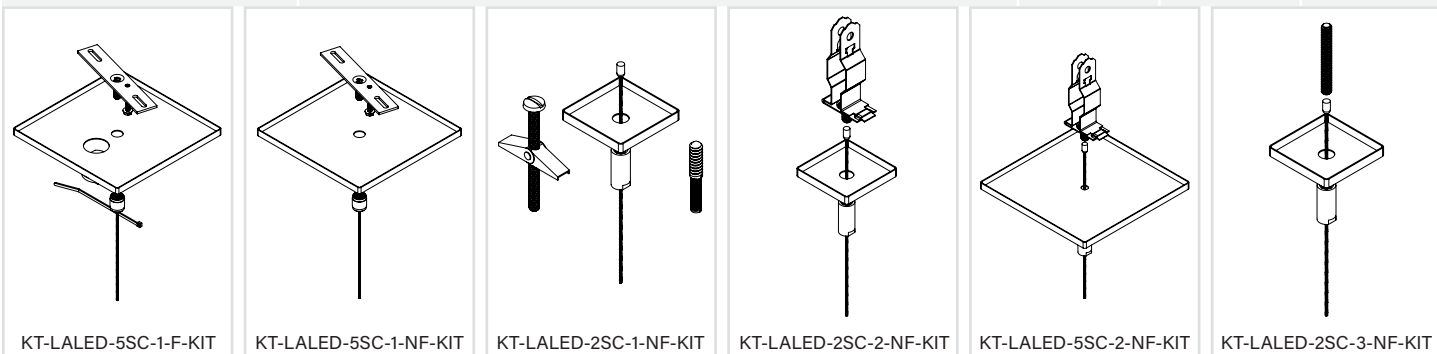

*Special Order Only: Please Contact Keystone for Availability

(Core Installation Accessories continued on next page)

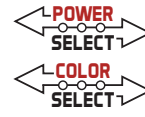

KT-LALEDXXPS-YA-8CSF-VDIM-X

LED LINEAR PENDANT FIXTURE

PENDANT MOUNT CORE INSTALLATION ACCESSORIES (continued)

| Catalog Number | Description | UPC | Easy Code |
|----------------|---|--------------|-----------|
| J-Box | | | |
| KT-JBOX-4TB | 4" Octagon Box / T-Bar Box. (3.5" across flats.) Includes punchouts to slide over T-Bar Grid. | 843654105062 | IRG-22 |

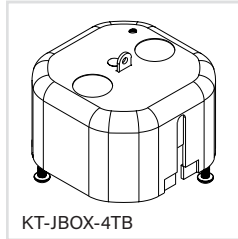

| Catalog Number | Description | UPC | Easy Code |
|-------------------------|--|--------------|-----------|
| Lens | | | |
| KT-LALED-A-32S-LENS-KIT | Monolithic Lens for KT-LALED fixtures. 32 ft Long Role. Cut to Desired Length in field | 843654156873 | WJF-44 |

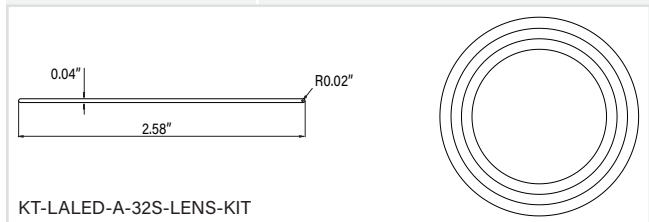

| Catalog Number | Description | Color | UPC | Easy Code |
|------------------------------|---|--------|--------------|-----------|
| Cord and Wire Harness | | | | |
| KT-CS-NP-10-18/5-W /LA* | 10' Input Power Cord, 18/5, 300V SJT Includes power quick connects and strain relief optimized for KT-LALED fixtures | White | 843654156880 | STY-97 |
| KT-CS-NP-10-18/5-B /LA | | Black | 843654161457 | GOL-44 |
| KT-CS-NP-10-18/5-S /LA | | Silver | 843654170046 | CKV-63 |
| KT-CS-NP-10-18/6-W /LA | 10' Input Power Cord, 18/6, 300V SJT Includes power quick connects and strain relief optimized for KT-LALED fixtures | White | 843654159164 | PNQ-23 |
| KT-CS-NP-10-18/6-B /LA | | Black | 843654159157 | GXA-52 |
| KT-CS-NP-10-18/6-S /LA | | Silver | 843654170053 | WFD-42 |
| KT-CS-515P-6-18/3-W /LA | (For Samples) Cordset with Plug for Linta Fixtures. 125V NEMA 5-15P Straight Blade Plug. 6ft long SJTW cable. 18/3 wire | White | 843654159171 | TBX-57 |
| KT-CS-515P-6-18/3-B /LA | | Black | 843654170022 | VUM-99 |
| KT-CS-515P-6-18/3-S /LA | | Silver | 843654170039 | OZZ-32 |
| KT-LALED-WH-MD-KIT | Wire Harness Kit for Multidirectional Power feed. Used in conjunction with an input power cord, when the feed location is in center of run. | N/A | 843654158532 | DLH-96 |

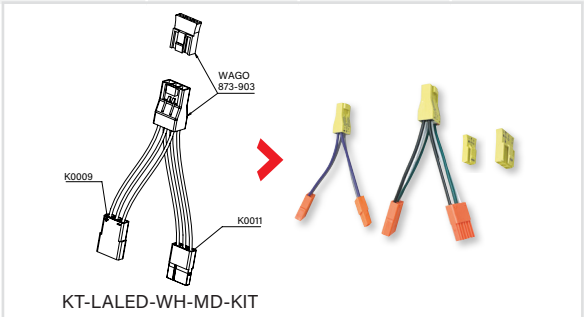
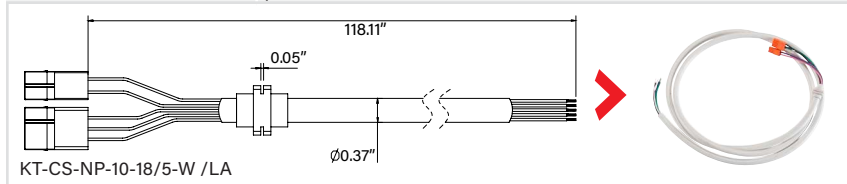

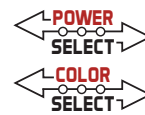

KT-LALEDXXPS-YA-8CSF-VDIM-X

LED LINEAR PENDANT FIXTURE

ALTERNATE MOUNTING ACCESSORIES (sold separately)

| Catalog Number | Description | Color | UPC | Easy Code |
|--|---|--------|--------------|-----------|
| Wall Mount Kits and Accessories | | | | |
| KT-LALED-2A-WM-KIT | Wall Mounting Kit for 2' Fixtures. Includes standard length 5 wire wiring harness | White | 843654157894 | NAJ-17 |
| KT-LALED-2A-WM-KIT-B | Wall Mounting Kit for 2' Fixtures. Includes standard length 5 wire wiring harness | Black | 843654161525 | JQS-70 |
| KT-LALED-2A-WM-KIT-S | Wall Mounting Kit for 2' Fixtures. Includes standard length 5 wire wiring harness | Silver | 843654169866 | GKC-20 |
| KT-LALED-3A-WM-KIT | Wall Mounting Kit for 3' Fixtures. Includes standard length 5 wire wiring harness | White | 843654157900 | NOO-02 |
| KT-LALED-3A-WM-KIT-B | Wall Mounting Kit for 3' Fixtures. Includes standard length 5 wire wiring harness | Black | 843654161532 | RFO-87 |
| KT-LALED-3A-WM-KIT-S | Wall Mounting Kit for 3' Fixtures. Includes standard length 5 wire wiring harness | Silver | 843654169873 | VSZ-80 |
| KT-LALED-4A-WM-KIT | Wall Mounting Kit for 4' Fixtures. Includes standard length 5 wire wiring harness | White | 843654156859 | ARZ-81 |
| KT-LALED-4A-WM-KIT-B | Wall Mounting Kit for 4' Fixtures. Includes standard length 5 wire wiring harness | Black | 843654161549 | VOV-66 |
| KT-LALED-4A-WM-KIT-S | Wall Mounting Kit for 4' Fixtures. Includes standard length 5 wire wiring harness | Silver | 843654169880 | KOF-44 |
| KT-LALED-8A-WM-KIT | Wall Mounting Kit for 8' Fixtures. Includes standard length 5 wire wiring harness | White | 843654156866 | EJW-29 |
| KT-LALED-8A-WM-KIT-B | Wall Mounting Kit for 8' Fixtures. Includes standard length 5 wire wiring harness | Black | 843654161556 | PLV-77 |
| KT-LALED-8A-WM-KIT-S | Wall Mounting Kit for 8' Fixtures. Includes standard length 5 wire wiring harness | Silver | 843654169897 | LKJ-15 |
| KT-LALED-A-LBR-WM | Linking Bracket for Wall Mount End to End daisychain connections. (Optional) | N/A | 843654158464 | WRU-16 |
| KT-LALED-WH-WM-20-KIT | Extended Length Wire Harness for wall mount kit, 20', 5 wire. For use with daisy chain wall mount installations with a center power feed location | N/A | 843654158549 | XGL-51 |
| KT-LALED-WH-WM-20EM-KIT | Extended Length Wire Harness for wall mount kit, 20', 6 wire. For use with daisy chain wall mount installations with a center power feed location for Emergency Backup Needs (extra conductor for switch leg) | N/A | 843654158556 | SPM-05 |



| Catalog Number | Description | Color | UPC | Easy Code |
|---|--------------------------------------|--------|--------------|-----------|
| Surface Mount Kits and Accessories | | | | |
| KT-LALED-2A-SM-KIT | Surface Mounting Kit for 2' Fixtures | White | 843654157870 | PZA-14 |
| KT-LALED-2A-SM-KIT-B | Surface Mounting Kit for 2' Fixtures | Black | 843654161488 | VCX-67 |
| KT-LALED-2A-SM-KIT-S | Surface Mounting Kit for 2' Fixtures | Silver | 843654169828 | CIF-29 |
| KT-LALED-3A-SM-KIT | Surface Mounting Kit for 3' Fixtures | White | 843654157887 | UON-33 |
| KT-LALED-3A-SM-KIT-B | Surface Mounting Kit for 3' Fixtures | Black | 843654161495 | OKS-15 |
| KT-LALED-3A-SM-KIT-S | Surface Mounting Kit for 3' Fixtures | Silver | 843654169835 | FSX-13 |
| KT-LALED-4A-SM-KIT | Surface Mounting Kit for 4' Fixtures | White | 843654156811 | UDG-40 |
| KT-LALED-4A-SM-KIT-B | Surface Mounting Kit for 4' Fixtures | Black | 843654161501 | UWO-08 |
| KT-LALED-4A-SM-KIT-S | Surface Mounting Kit for 4' Fixtures | Silver | 843654169842 | EPI-75 |
| KT-LALED-8A-SM-KIT | Surface Mounting Kit for 8' Fixtures | White | 843654156828 | YUT-17 |
| KT-LALED-8A-SM-KIT-B | Surface Mounting Kit for 8' Fixtures | Black | 843654161518 | QOE-60 |
| KT-LALED-8A-SM-KIT-S | Surface Mounting Kit for 8' Fixtures | Silver | 843654169859 | CMI-91 |





KT-LALEDXXPS-YA-8CSF-VDIM-X

LED LINEAR PENDANT FIXTURE

ALTERNATE MOUNTING ACCESSORIES (sold separately) (continued)

| Catalog Number | Description | UPC | Easy Code |
|--|---|--------------|-----------|
| Recessed Mount Kits and Accessories | | | |
| KT-LALED-2A-RM-KIT | Recessed Mounting Kit for 2' Fixtures in Drywall Ceilings | 843654158495 | NVI-25 |
| KT-LALED-3A-RM-KIT | Recessed Mounting Kit for 3' Fixtures in Drywall Ceilings | 843654158501 | SYQ-66 |
| KT-LALED-4A-RM-KIT | Recessed Mounting Kit for 4' Fixtures in Drywall Ceilings | 843654156835 | ZXE-03 |
| KT-LALED-8A-RM-KIT | Recessed Mounting Kit for 8' Fixtures in Drywall Ceilings | 843654156842 | GSI-69 |

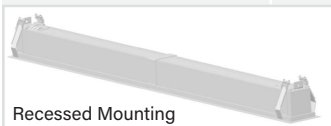

ACCESSORIES

SENSORS/CONTROLLERS

Factory-Installable OR Field-Installable (field-installable purchased separately)

| ✓ | Suffix* | Catalog number | Description | UPC | Easy Code |
|---|---------|------------------------|--|--------------|-----------|
| | /FC2 | KTSL-FC2-12V-SM-PIR | Bluetooth mesh wireless low voltage individual fixture controller for SmartLoop system with integrated daylight and PIR motion sensors, 12V, 0-10V Dimming. White controller body | 843654135236 | TCM-01 |
| | /FC5 | KTSL-FC5-12V-IM-PIR | Bluetooth mesh wireless low voltage individual fixture controller for SmartLoop system with integrated daylight and PIR motion sensors, 12V, 0-10V Dimming. White controller body | 843654164342 | ODF-32 |
| | /FC5B | KTSL-FC5-12V-IM-PIR-B | Bluetooth mesh wireless low voltage individual fixture controller for SmartLoop system with integrated daylight and PIR motion sensors, 12V, 0-10V Dimming. Black controller body | 843654164359 | OJA-51 |
| | /FC5S | KTSL-FC5-12V-IM-PIR-S* | Bluetooth mesh wireless low voltage individual fixture controller for SmartLoop system with integrated daylight and PIR motion sensors, 12V, 0-10V Dimming. Silver controller body | 843654172347 | PHP-99 |



*Special order only

Field-Installable (field-installable purchased separately)

| Catalog number | Description | UPC | Easy Code |
|----------------------|---|--------------|-----------|
| KT-LALED-A-EC-SL | End Cap for Series A Linear Arch Fixtures for use with SmartLoop KTSL-FC2-12V-SM-PIR | 843654156767 | WMK-35 |
| KT-LALED-A-EC-SL-B | End Cap for Series A Linear Arch Fixtures for use with SmartLoop KTSL-FC2-12V-SM-PIR | 843654161464 | LGF-83 |
| KT-LALED-A-EC-SL-2 | End Cap for Series A White Linear Arch Fixtures for use with SmartLoop KTSL-FC5-12V-IM-PIR | 843654166452 | ATE-48 |
| KT-LALED-A-EC-SL-2-B | End Cap for Series A Black Linear Arch Fixtures for use with SmartLoop KTSL-FC5-12V-IM-PIR-B | 843654166469 | GKM-05 |
| KT-LALED-A-EC-SL-2-S | End Cap for Series A Silver Linear Arch Fixtures for use with SmartLoop KTSL-FC5-12V-IM-PIR | 843654169804 | HRY-50 |
| KTSL-FC5-WH-23 | Wiring Harness for KTSL-FC5 Fixture Controllers. 23.6in Long with Mating Connector. Low voltage | 843654164946 | PEI-71 |



*FOR FACTORY INSTALLATION OF ACCESSORY, ADD SUFFIX TO FIXTURE PART NUMBER (SEE ORDERING EXAMPLES AND INSTRUCTIONS ON LAST PAGE OF SPEC SHEET).

**Factory installation of Sensor will automatically include any relevant mounting bracket

***Sensor only compatible with pendant mount hanging installation. Not for use with Wall, Surface, or recessed mount applications



KT-LALEDXXPS-YA-8CSF-VDIM-X

LED LINEAR PENDANT FIXTURE

ACCESSORIES (continued)

Field-Installable (field-installable purchased separately)

| Catalog number | Description | UPC | Easy Code |
|----------------------|--|--------------|-----------|
| KT-LALED-A-MR-SL-2 | Integrated Sensor Mount for Series A Linear Arch Fixtures for use with KTSL-FC5-12V-IM-PIR | 843654172293 | DSC-97 |
| KT-LALED-A-MR-SL-2-B | Integrated Sensor Mount for Series A Linear Arch Fixtures for use with KTSL-FC5-12V-IM-PIR | 843654172309 | RZB-30 |
| KT-LALED-A-MR-SL-2-S | Integrated Sensor Mount for Series A Linear Arch Fixtures for use with KTSL-FC5-12V-IM-PIR | 843654172316 | NSG-29 |



Integrated Sensor Mount
KT-LALED-A-MR-SL-2



Integrated Sensor Mount
KT-LALED-A-MR-SL-2-B



Integrated Sensor Mount
KT-LALED-A-MR-SL-2-S

EMERGENCY BACKUPS

Factory-Installable OR Field-Installable (field-installable purchased separately)

| ✓ | Suffix* | Catalog number | Description | UPC | Easy Code |
|---|---------|----------------------------|---|--------------|-----------|
| | /EM5† | KT-EMRG-LED-5C-500-SEN | LED Emergency Backup, One Piece Slim 5W Constant Wattage Design, Approx 500 Lumens. 90 Min Operation, 120-277V Input, CEC T20 Compliant. Includes Test Switch and Wiring Accessories. | 843654128276 | CPO-29 |
| | /EM10 | KT-EMRG-LED-10BC-1000-SEN2 | LED Emergency Backup, One Piece Slim 10W Constant Wattage Design, Approx 1000 Lumens. 90 Min Operation, 120-277V Input, CEC T20 Compliant. Includes Test Switch and Wiring Accessories. | 843654167626 | ROM-77 |



5W, 500 Lumen Battery Backup
KT-EMRG-LED-5C-500-SEN



10W, 1000 Lumen Battery Backup
KT-EMRG-LED-10BC-1000-SEN2

* FOR FACTORY INSTALLATION OF ACCESSORY, ADD SUFFIX TO FIXTURE PART NUMBER (SEE ORDERING EXAMPLES AND INSTRUCTIONS ON LAST PAGE OF SPEC SHEET).)

**Factory installation of Emergency Backup will automatically include any relevant accessories to accommodate the installation

***Emergency Backup is NOT compatible with 2' and 3' fixtures. 4' and 8' only.

MOUNTS/BRACKETS

Field-Installable (field-installable purchased separately)

| Catalog number | Description | UPC | Easy Code |
|-----------------------|---|--------------|-----------|
| KT-LALED-A-EC-EM | End Cap for Emergency backup test button | 843654156774 | DGB-72 |
| KT-LALED-A-EC-EM-B | End Cap for Emergency backup test button | 843654161471 | LVQ-86 |
| KT-LALED-A-EC-EM-S | End Cap for Emergency backup test button | 843654169811 | HMQ-55 |
| KT-LALED-CANOPY-1-KIT | Pair of 5" circular canopy covers, with included hardware to install (1) fixture. One Power Feed one Non-Power Feed. For use with standard J-Box / Stud mount installations. Compatible with aircraft cable hardware included with each fixture | 843654156798 | ZAW-46 |
| KT-LALED-CABLE-1-KIT | Standard Cable Hanging Kit, suitable for Hard Ceiling or Loop Over Hanging Installations (Replacement for what is included in each fixture) | 843654156781 | TUV-08 |
| KT-LALED-A-LBR | Linking Bracket for End to End Linear Connections. (Replacement for what is included in each fixture) | 843654156804 | IAI-11 |



KT-LALEDXXPS-YA-8CSF-VDIM-X

LED LINEAR PENDANT FIXTURE

ACCESSORIES (continued)

LOUVERS

Field-Installable (field-installable purchased separately)

| Catalog number | Description | UPC | Easy Code |
|-----------------------|---|--------------|-----------|
| KT-LALED-LA-LVR-1-KIT | Hexagonal Louver Kit for L Shape Series A Linear Arch Fixtures. Louver compatible end caps sold separately | 843654161839 | OUL-45 |
| KT-LALED-TA-LVR-1-KIT | Hexagonal Louver Kit for T Shape Series A Linear Arch Fixtures. Louver compatible end caps sold separately | 843654161846 | NWZ-74 |
| KT-LALED-XA-LVR-1-KIT | Hexagonal Louver Kit for X Shape Series A Linear Arch Fixtures. Louver compatible end caps sold separately | 843654155852 | FZR-68 |
| KT-LALED-LA-LVR-2-KIT | Straight Blade Louver Kit for L Shape Series A Linear Arch Fixtures. Louver compatible end caps sold separately | 843654158518 | QQN-59 |
| KT-LALED-TA-LVR-2-KIT | Straight Blade Louver Kit for T Shape Series A Linear Arch Fixtures. Louver compatible end caps sold separately | 843654158525 | RRG-31 |
| KT-LALED-XA-LVR-2-KIT | Straight Blade Louver Kit for X Shape Series A Linear Arch Fixtures. Louver compatible end caps sold separately | 843654108773 | QEF-39 |

Field-Installable (field-installable purchased separately)

| Catalog number | Description | UPC | Easy Code |
|---------------------|--|--------------|-----------|
| KT-LALED-A-EC-LVR | End Cap for Series A Linear Arch Fixtures for use with all Louver Kits | 843654161778 | LNМ-84 |
| KT-LALED-A-EC-LVR-B | End Cap for Series A Linear Arch Fixtures for use with all Louver Kits | 843654161785 | SCQ-55 |



Hexagonal Louver Kit
KT-LALED-LA-LVR-1-KIT



Straight Blade Louver Kit
KT-LALED-LA-LVR-2-KIT

ORDERING INFORMATION

| Catalog Number | Pack Quantity | Weight | UPC | Easy Code | |
|-----------------------------|---------------|----------|--------------|--------------|--------|
| KT-LALED20PS-2A-8CSF-VDIM | 1 | 4.5 lbs | 843654156729 | OLD-23 | |
| KT-LALED20PS-2A-8CSF-VDIM-B | | | 843654161389 | OIG-02 | |
| KT-LALED20PS-2A-8CSF-VDIM-S | | | 843654169736 | UTQ-13 | |
| KT-LALED30PS-3A-8CSF-VDIM | | 5.7 lbs | 5.7 lbs | 843654156736 | OTA-53 |
| KT-LALED30PS-3A-8CSF-VDIM-B | | | | 843654161396 | UHH-97 |
| KT-LALED30PS-3A-8CSF-VDIM-S | | | | 843654169743 | ZRQ-86 |
| KT-LALED40PS-4A-8CSF-VDIM | | 7.0 lbs | 7.0 lbs | 843654156743 | TBO-54 |
| KT-LALED40PS-4A-8CSF-VDIM-B | | | | 843654161402 | HGE-33 |
| KT-LALED40PS-4A-8CSF-VDIM-S | | | | 843654169750 | HTA-17 |
| KT-LALED80PS-8A-8CSF-VDIM | | 13.0 lbs | 13.0 lbs | 843654156750 | ULO-92 |
| KT-LALED80PS-8A-8CSF-VDIM-B | | | | 843654161419 | KZB-70 |
| KT-LALED80PS-8A-8CSF-VDIM-S | | | | 843654169767 | LJM-16 |

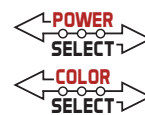

KT-LALEDXXPS-YA-8CSF-VDIM-X

LED LINEAR PENDANT FIXTURE

CATALOG NUMBER BREAKDOWN

KT-LALEDXXPS-YA-8CSF-VDIM-X

1
2
3
4
5
6
7
8
9
10
11

- 1** Keystone Technologies
- 2** Linear Architectural LED Fixture
- 3** Wattage
- 4** Power Select
- 5** Nominal Length
- 6** Series/Form Factor
- 7** 80 CRI
- 8** Color Select
- 9** Color Select Designation
- 10** 0-10V Dimming
- 11** Housing Color*

3 Wattage

| | |
|----|-----|
| 20 | 20W |
| 30 | 30W |
| 40 | 40W |
| 80 | 80W |

5 Nominal Size

| | |
|---|----|
| 2 | 2' |
| 3 | 3' |
| 4 | 4' |
| 8 | 8' |

9 Color Select Designation

| | |
|----------|---------------------------|
| F | 2700/3000/3500/4000/5000K |
|----------|---------------------------|

11 Housing Color

| | |
|----------|--------|
| | White |
| B | Black |
| S | Silver |



*White, Black, and Silver Standard. Other finishes available, lead times apply. Contact Keystone sales rep for details/options on colors other than White and Black.

ORDERING EXAMPLES

FIXTURE WITH TWO FACTORY-INSTALLED ACCESSORIES*

KT-LALEDXXPS-YA-8CSF-VDIM/FC2/EM5

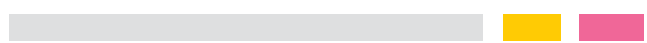

FIXTURE WITH SINGLE FACTORY-INSTALLED ACCESSORY

KT-LALEDXXPS-YA-8CSF-VDIM/FC2

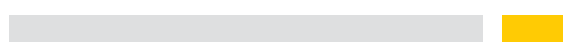

FIXTURE WITH NO FACTORY-INSTALLED ACCESSORIES

KT-LALEDXXPS-YA-8CSF-VDIM

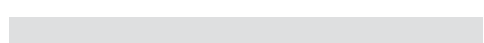

* When ordering more than one factory-installed accessory, use multiple suffixes as shown in the ordering examples above.
Note: All accessories can also be ordered separately for field installation using just their regular Catalog Number, UPC, or Easy Code.

| KEYSTONE FIXTURE | |
|-------------------------------------|-----------------------------|
| Catalog number | |
| KT-LALEDXXPS-YA-8CSF-VDIM | |
| SENSORS/CONTROLLERS | |
| <input checked="" type="checkbox"/> | Suffix* |
| | Catalog number |
| | /FC2 KTSL-FC2-12V-SM-PIR |
| EMERGENCY BACKUPS | |
| <input checked="" type="checkbox"/> | Suffix* |
| | Catalog number |
| | /EM5 KT-EMRG-LED-5C-500-SEN |