

Hi-lume® A-Series Driver Overview EcoSystem® or 3-wire control

Hi-lume® A-Series Driver is a high-performance LED driver that provides smooth, continuous 1% dimming for virtually any LED fixture, whether it requires constant-current or constant-voltage. It is the most versatile LED driver offered today due to its compatibility with a wide variety of LED arrays, multiple form factors, and numerous control options.

Features

- Continuous, flicker-free dimming from 100% to 1%.
- Compatible with Energi Savr Node™ unit with EcoSystem®, GRAFIK Eye® QS control unit, PowPak® dimming module with EcoSystem®, and Quantum® systems, allowing for integration into a planned or existing EcoSystem® lighting control solution. Please see chart at the end of this document or contact Lutron for details regarding compatible controls.
- Standard 3-wire line-voltage phase-control technology for consistent dimming performance and compatibility with all Lutron® 3-wire fluorescent controls.
- Line voltage miswire protection on EcoSystem® control inputs.
- 100% performance tested at factory.
- A rated lifetime of 50,000 hours @ $t_c = 65^\circ\text{C}$.
- UL recognized for United States and Canada.
- FCC Part 15 compliant for commercial applications at 120 V \sim or 277 V \sim .
- Pulse Width Modulation (PWM) or Constant-Current Reduction (CCR) dimming methods available. See Application Note #360 for details.
- RoHS Compliant.
- For more information please go to: www.lutron.com/HilumeLED

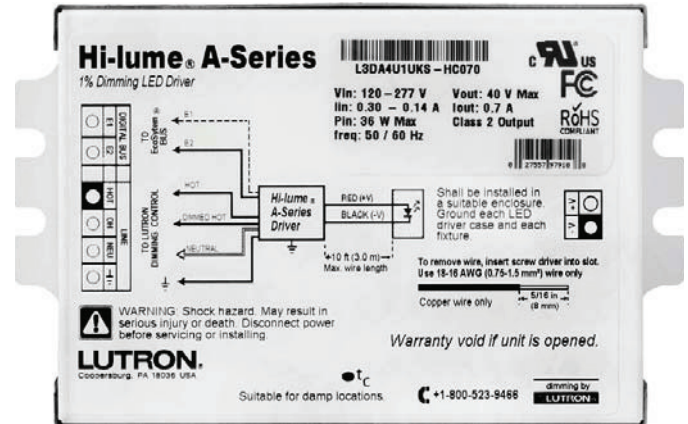

Hi-lume® A-Series, case type K

3.00 in (76 mm) W x 1.00 in (25 mm) H x
4.90 in (124 mm) L



Hi-lume® A-Series, case type M

1.18 in (30 mm) W x 1.00 in (25 mm) H x
14.25 in (362 mm) L

Job Name:	Model Numbers:	
<input type="text"/>	<input type="text"/>	<input type="text"/>
Job Number:	<input type="text"/>	<input type="text"/>

Specifications

Performance

- Dimming Range: 100% to 1%
- Operating Voltage: 120–277 V \sim at 50/60 Hz
- A rated lifetime of 50,000 hours @ $t_c = 65^\circ\text{C}$. Contact Lutron for derating information.
- Patented thermal foldback protection.
- LEDs turn on to any dimmed level without going to full brightness.
- Non-volatile memory restores all driver settings after power failure.
- Power Factor: > 0.90 for loads greater than 25 W
- Standby Power Consumption: < 1.0 W
- Total Harmonic Distortion (THD): < 20% for loads greater than 25 W
- Inrush Current: < 2 A
- Inrush Current Limiting Circuitry: eliminates circuit breaker tripping, switch arcing and relay failure.
- Open circuit protected
- Short circuit protected
- Turn-on time: ≤ 1 second
- PWM Dimming Frequency: 550 Hz

Environmental

- Sound Rating: Class A.
- Relative Humidity: Maximum 90% non-condensing.
- Minimum operating ambient temperature $t_a = 32^\circ\text{F}$ (0°C).

Standards

- Meets ANSI C62.41 category A surge protection standards up to and including 4 kV.
- FCC Part 15 compliant for commercial applications at 120 V \sim or 277 V \sim .
- Manufacturing facilities employ ESD reduction practices that comply with the requirements of ANSI/ESD S20.20.

- Lutron® Quality Systems registered to ISO 9001.2008.
- UL 8750 recognized.
- Class 2 output available.
- Models available to meet LED Driver requirements for Energy Star 1.1.

Driver Wiring & Mounting

- Driver is grounded by a mounting screw to the grounded fixture (or by terminal connection on the K case).
- Terminal blocks on the driver accept one solid wire per terminal from 18 to 16 AWG (0.75 to 1.5 mm²).
- Fixture must be grounded in accordance with local and national electrical codes.

- Maximum driver-to-LED light engine wire length for **Constant-Current Drivers:**

Wire Gauge	Maximum Lead Length		
	200 mA to 700 mA	710 mA to 1.50 A	1.51 A to 2.10 A
18 AWG (0.75 mm ²)	30 ft (9 m)	15 ft (4.5 m)	10 ft (3 m)
16 AWG (1.5 mm ²)	35 ft (10.5 m)	25 ft (7.5 m)	15 ft (4.5 m)
14 AWG (2.5 mm ²)	50 ft (15 m)	40 ft (12 m)	25 ft (7.5 m)
12 AWG (4.0 mm ²)	100 ft (30 m)	60 ft (18 m)	40 ft (12 m)

- Maximum driver-to-LED light engine wire length for **Constant-Voltage Drivers:**

Wire Gauge	Maximum Lead Length		
	10 V to 20 V	20.5 V to 40 V	40.5 V to 60 V
18 AWG (0.75 mm ²)	10 ft (3 m)	15 ft (4.5 m)	30 ft (9 m)
16 AWG (1.5 mm ²)	15 ft (4.5 m)	25 ft (7.5 m)	50 ft (15 m)
14 AWG (2.5 mm ²)	25 ft (7.5 m)	40 ft (12 m)	75 ft (22.5 m)
12 AWG (4.0 mm ²)	40 ft (12 m)	60 ft (18 m)	100 ft (30 m)

Job Name: <input style="width: 90%; height: 20px;" type="text"/>	Model Numbers: <input style="width: 95%; height: 20px;" type="text"/>
Job Number: <input style="width: 150px; height: 20px;" type="text"/>	<input style="width: 95%; height: 20px;" type="text"/>

How to Build a Model Number: Hi-lume® A-Series

L3DA4U1U

Case Size:

K = Compact
M = Stick

Case Style:

S = Studded
(K case only)
N = Non-Studded

example: L3DA4U1UKS-HC070

For further assistance selecting your model number, contact our LED Center of Excellence at 1.877.346.5338 or LEDs@lutron.com

Current Level (for Constant-Current):

020 = 0.20 A; 021 = 0.21 A . . . 070 = 0.70 A . . . 210 = 2.10 A

Voltage Level (for Constant-Voltage):

100 = 10.0 V; 105 = 10.5 V . . . 600 = 60.0 V

Driver Output:

C = Constant-current driver
with pulse width modulation (PWM) dimming
A = Constant-current driver
with constant-current reduction (CCR) dimming
V = Constant-voltage driver
with pulse width modulation (PWM) dimming

LED Load Output Range (see the following pages for more detail):

Class 2 Constant-Voltage

A = 10.0 V–12.0 V
B = 12.5 V–20.0 V
C = 20.5 V–24.0 V
D = 24.5 V–38.0 V

Isolated Non-Class 2
Constant-Voltage

X = 38.5 V–60.0 V

Class 2 Constant-Current

E = 0.20 A–0.50 A 30 V–54 V
F = 0.51 A–1.00 A 30 V–54 V
G = 0.20 A–0.70 A 8 V–20 V
H = 0.20 A–0.70 A 15 V–38 V
I = 0.71 A–1.05 A 8 V–20 V
J = 0.71 A–1.05 A 15 V–38 V
K = 1.06 A–1.50 A 8 V–20 V
L = 1.06 A–1.50 A 15 V–38 V
M = 1.51 A–2.10 A 8 V–20 V

Isolated Non-Class 2
Constant-Current

Y = 0.20 A–0.50 A 30 V–60 V
Z = 0.51 A–1.00 A 30 V–60 V

Job Name: <input style="width: 90%; height: 20px;" type="text"/>	Model Numbers: <input style="width: 60%; height: 20px;" type="text"/> <input style="width: 35%; height: 20px;" type="text"/>	
Job Number: <input style="width: 100%; height: 20px;" type="text"/>	<input style="width: 100%; height: 20px;" type="text"/>	

“A” Output Range, Voltage Driver Models

Driver Type	Output Dimming Method	Output Voltage	Output Current	Output Power	Standards Recognition
Constant-Voltage Driver (Class 2)	Pulse Width Modulation (PWM)	10.0–12.0 V PWM	0.42–3.3 A	5–40 W	

Voltage Driver Operation Range:

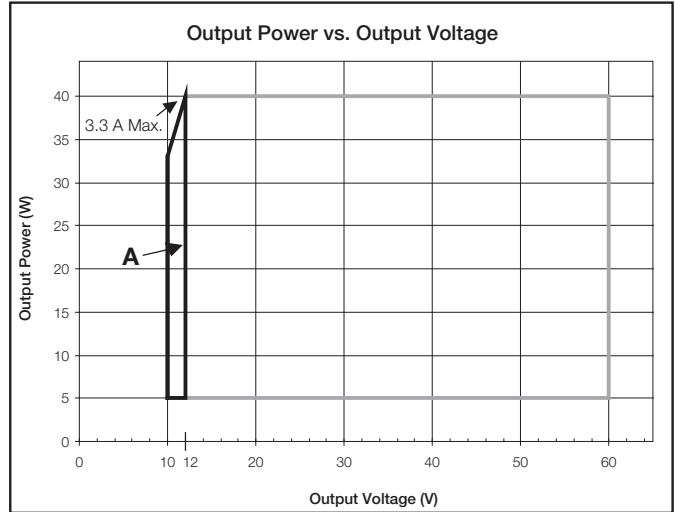
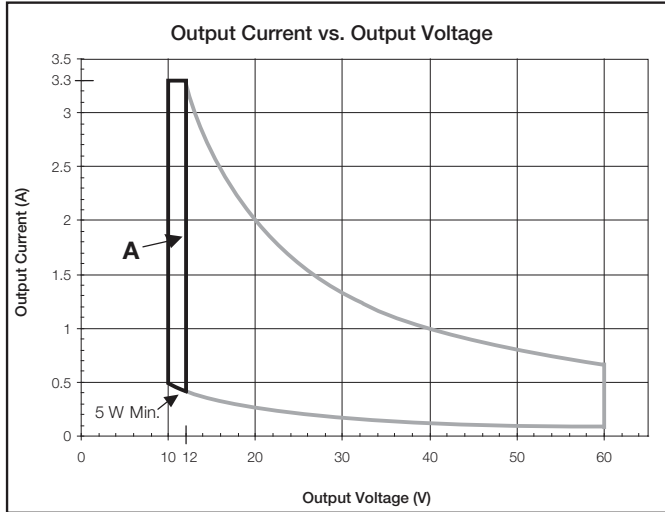

Typical Performance Specifications:

Parameter	120 V~	240 V~	277 V~	Test Conditions
Input Current	390 mA	210 mA	170 mA	$t_a = 25\text{ }^\circ\text{C}$, 12.0 V 40 W load, Max. Light Output, K enclosure
Power Factor	0.99	0.97	0.95	
THD	14%	17%	16%	
Driver Efficiency	81%	83%	83%	

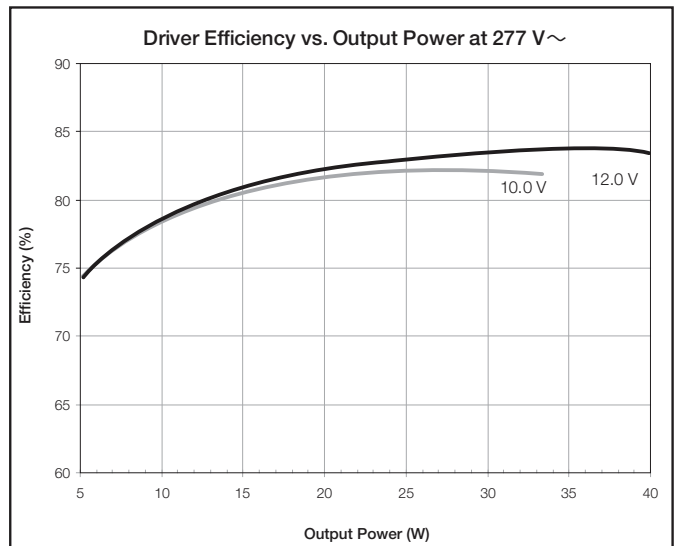
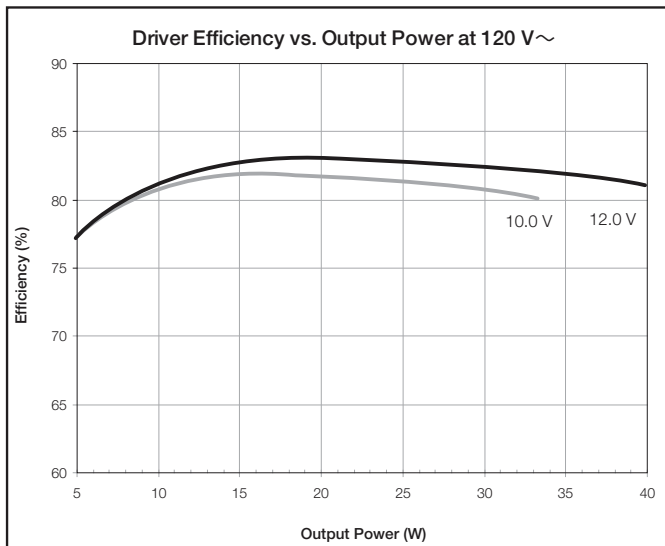

Job Name: <input style="width: 90%; height: 20px;" type="text"/>	Model Numbers: <input style="width: 90%; height: 20px;" type="text"/>	
Job Number: <input style="width: 90%; height: 20px;" type="text"/>		

“B” Output Range, Voltage Driver Models

Driver Type	Output Dimming Method	Output Voltage	Output Current	Output Power	Standards Recognition
Constant-Voltage Driver (Class 2)	Pulse Width Modulation (PWM)	12.5–20.0 V PWM	0.25–3.2 A	5–40 W	

Voltage Driver Operation Range:

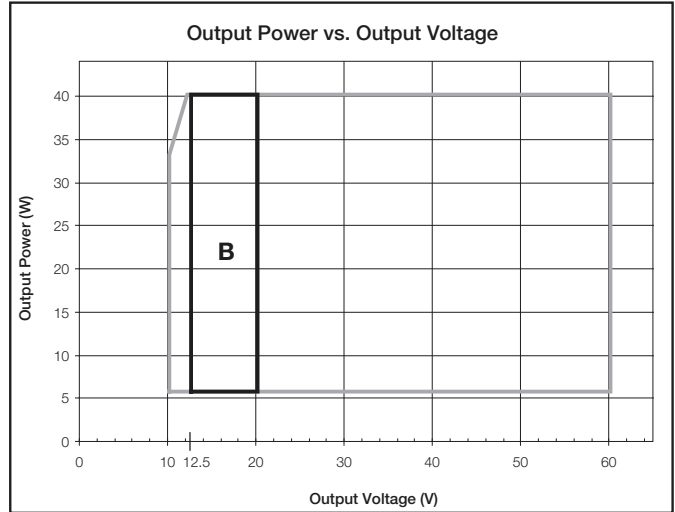
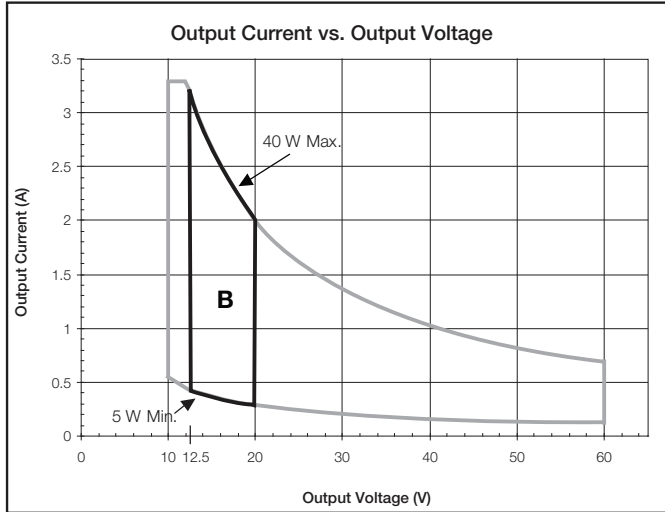

Typical Performance Specifications:

Parameter	120 V~	240 V~	277 V~	Test Conditions
Input Current	390 mA	200 mA	170 mA	$t_a = 25\text{ }^\circ\text{C}$, 20.0 V 40 W load, Max. Light Output, K enclosure
Power Factor	0.99	0.98	0.97	
THD	10%	8%	9%	
Driver Efficiency	85%	86%	87%	

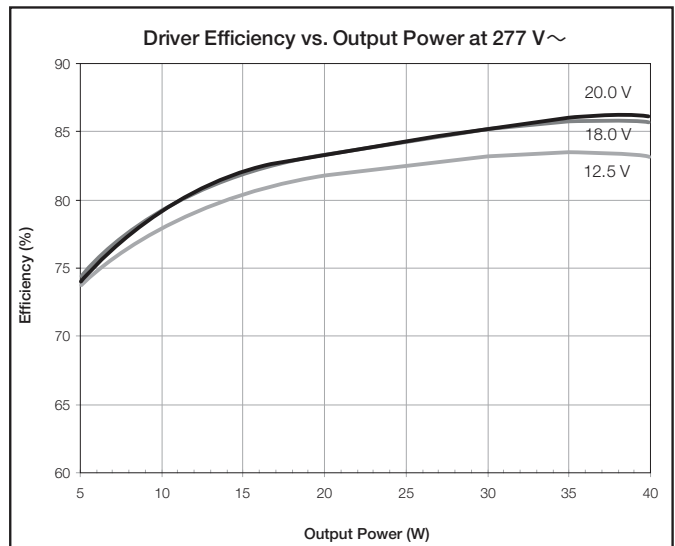
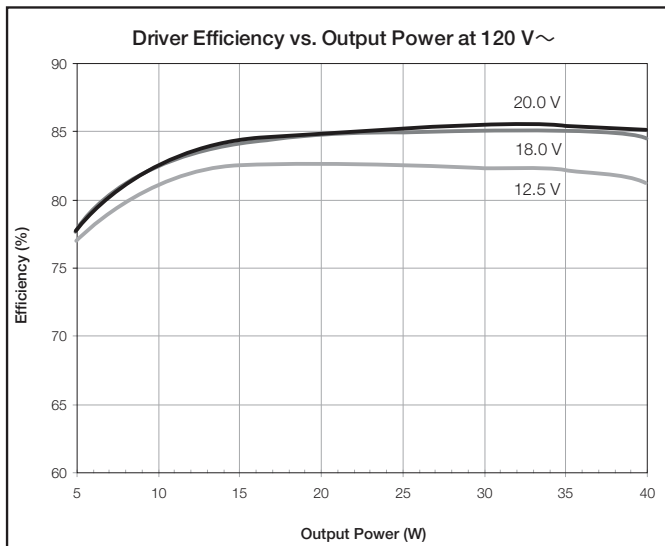

Job Name: <input style="width: 90%; height: 20px;" type="text"/>	Model Numbers: <input style="width: 90%; height: 20px;" type="text"/>	
Job Number: <input style="width: 90%; height: 20px;" type="text"/>		

“C” Output Range, Voltage Driver Models

Driver Type	Output Dimming Method	Output Voltage	Output Current	Output Power	Standards Recognition
Constant-Voltage Driver (Class 2)	Pulse Width Modulation (PWM)	20.5–24.0 V PWM	1.95–0.21 A	5–40 W	

Voltage Driver Operation Range:

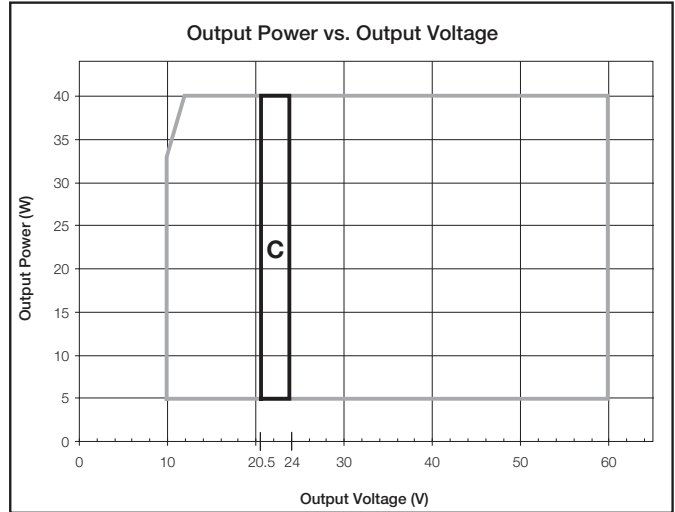
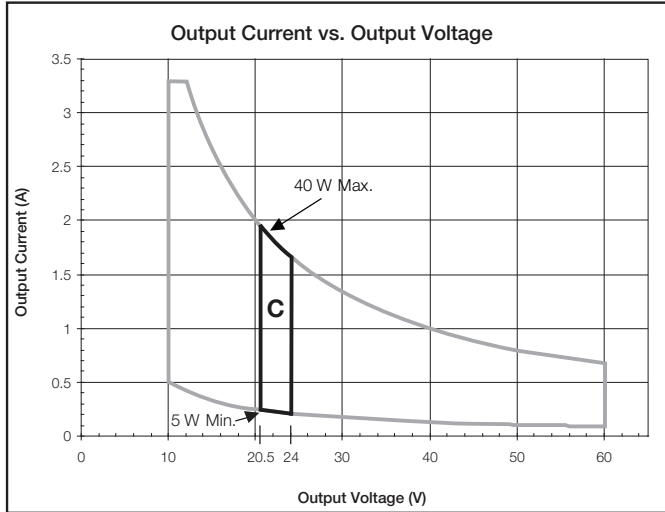

Typical Performance Specifications:

Parameter	120 V~	240 V~	277 V~	Test Conditions
Input Current	370 mA	190 mA	170 mA	t _a = 25 °C, 24.0 V 40 W load, Max. Light Output, K enclosure
Power Factor	0.99	0.97	0.96	
THD	10%	10%	12%	
Driver Efficiency	86%	87%	88%	

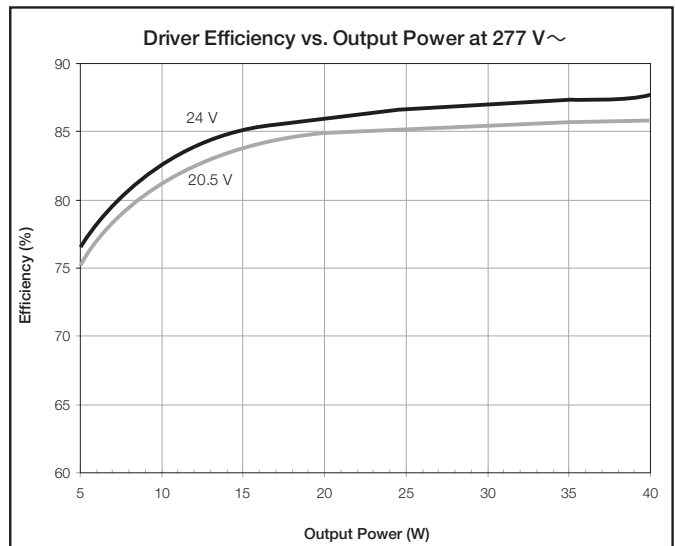
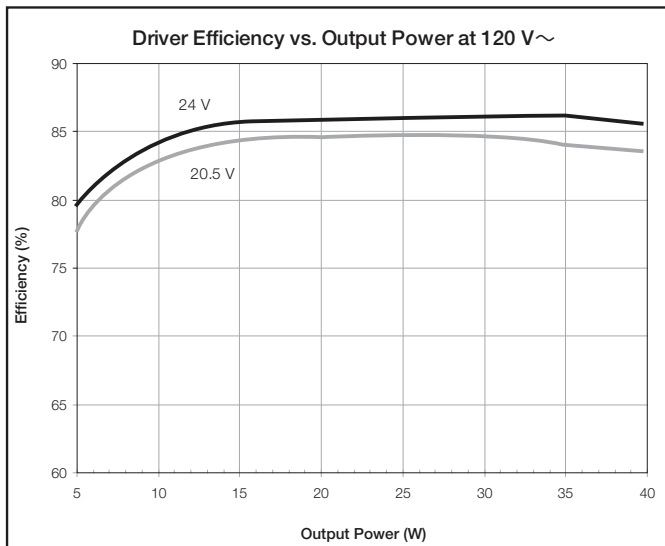

Job Name: <input style="width: 90%; height: 20px;" type="text"/>	Model Numbers: <input style="width: 95%; height: 20px;" type="text"/>
Job Number: <input style="width: 100%; height: 20px;" type="text"/>	<input style="width: 95%; height: 20px;" type="text"/>

“D” Output Range, Voltage Driver Models

Driver Type	Output Dimming Method	Output Voltage	Output Current	Output Power	Standards Recognition
Constant-Voltage Driver (Class 2)	Pulse Width Modulation (PWM)	24.5–38.0 V PWM	0.13–1.63 A	5–40 W	

Voltage Driver Operation Range:

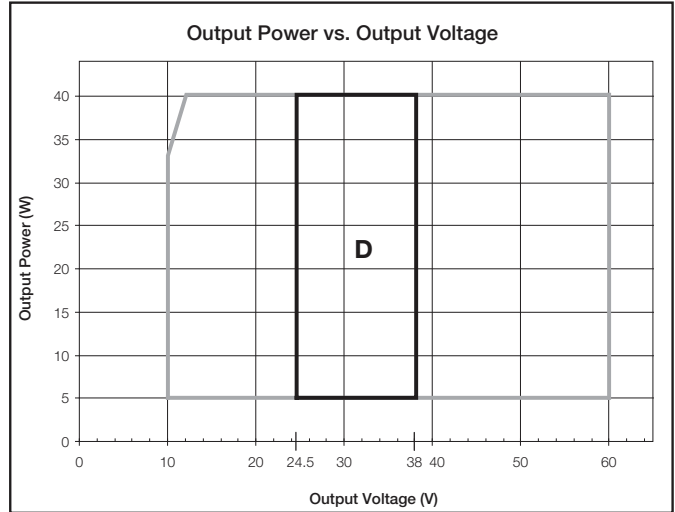
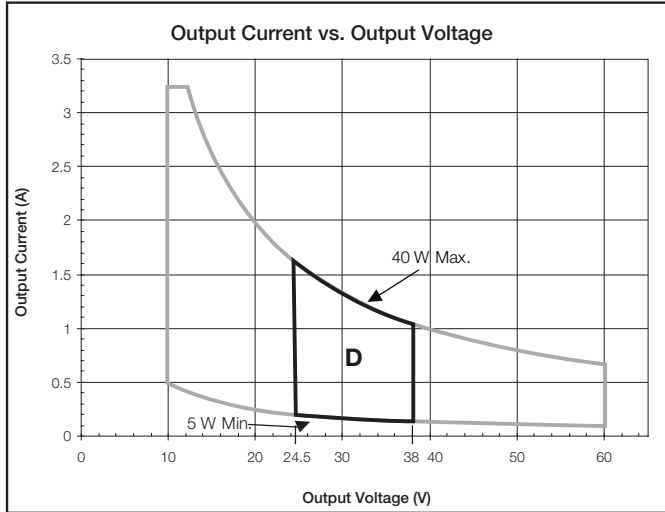

Typical Performance Specifications:

Parameter	120 V~	240 V~	277 V~	Test Conditions
Input Current	370 mA	190 mA	170 mA	t _a = 25 °C, 38.0 V 40 W load, Max. Light Output, K enclosure
Power Factor	0.99	0.98	0.98	
THD	6%	9%	11%	
Driver Efficiency	87%	88%	88%	

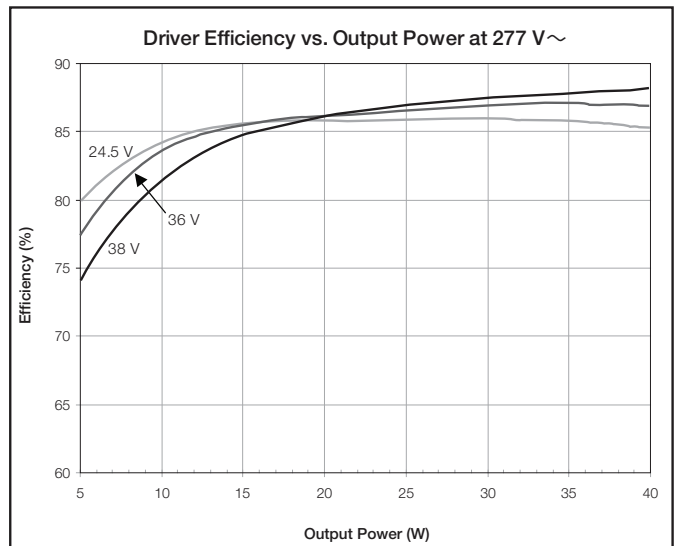
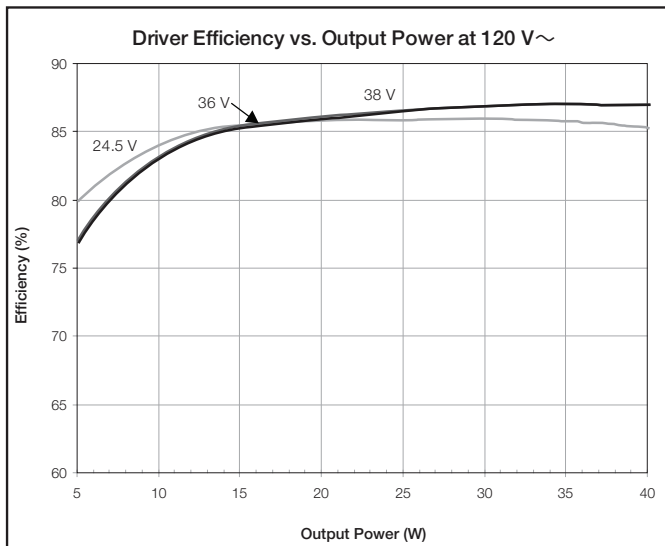

Job Name: <input style="width: 90%;" type="text"/>	Model Numbers: <input style="width: 90%;" type="text"/>	
Job Number: <input style="width: 90%;" type="text"/>	<input style="width: 90%;" type="text"/>	<input style="width: 90%;" type="text"/>

“E” Output Range, Current Driver Models

Driver Type	Output Dimming Method	Output Voltage	Output Current	Output Power	Standards Recognition
Constant-Current Driver (Class 2)	Constant-Current Reduction (CCR)	30–54 V \approx	0.20–0.50 A	6–27 W	

Current Driver Operation Range:

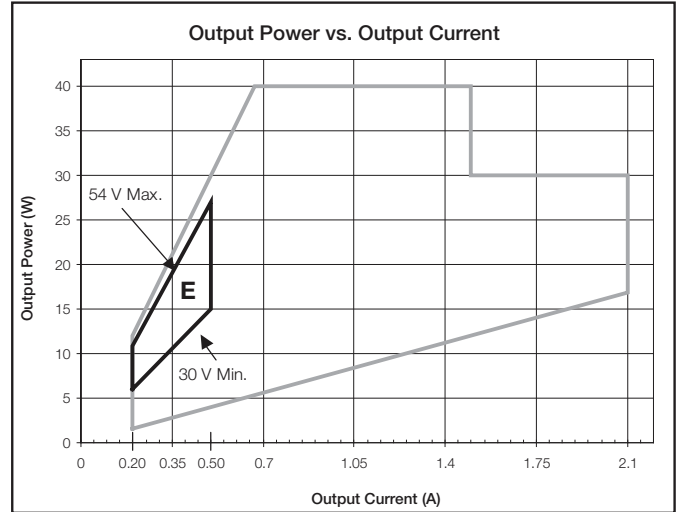
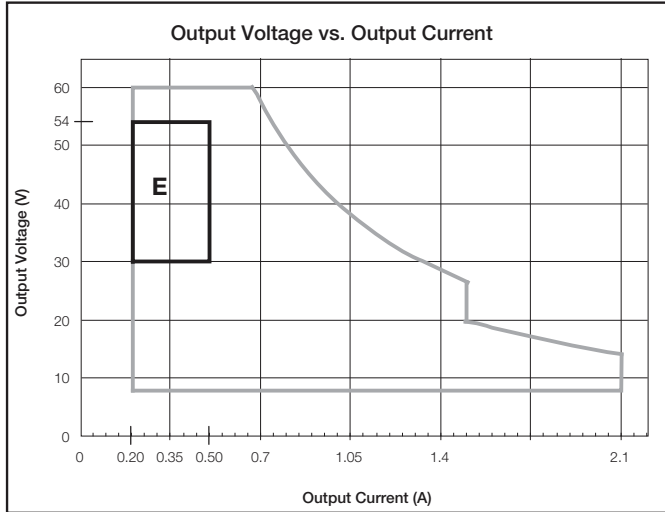

Typical Performance Specifications:

Parameter	120 V \sim	240 V \sim	277 V \sim	Test Conditions
Input Current	260 mA	140 mA	110 mA	$t_a = 25^\circ\text{C}$, 0.50 A 27 W load, Max. Light Output, K enclosure
Power Factor	0.99	0.98	0.96	
THD	10%	10%	12%	
Driver Efficiency	85%	85%	85%	

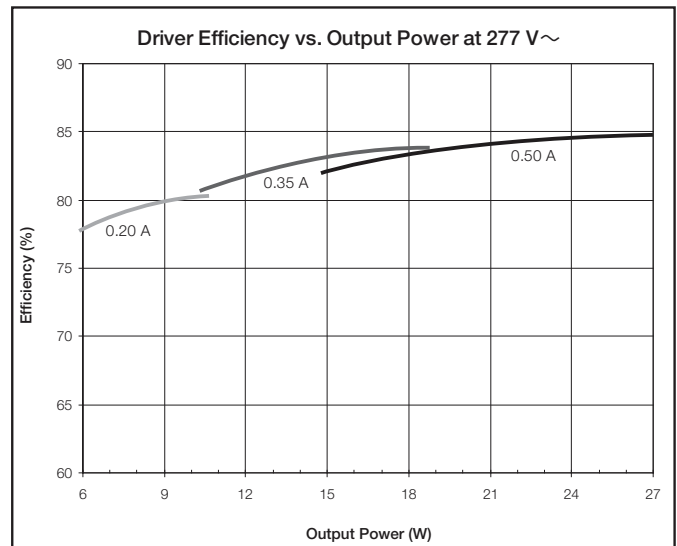
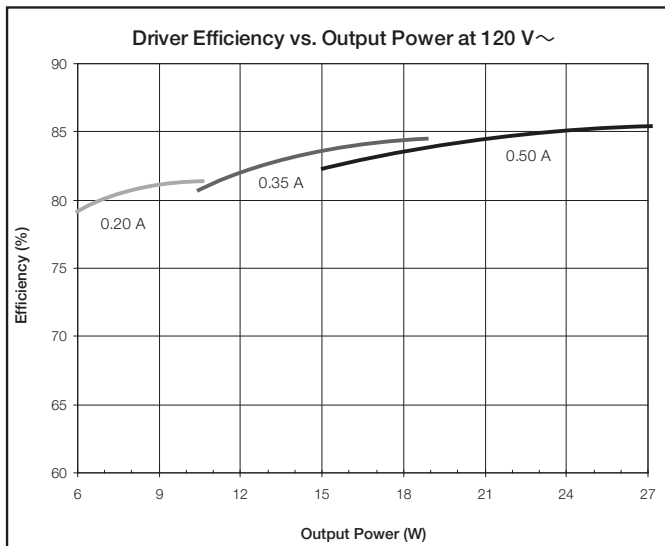

Job Name: <input style="width: 90%; height: 20px;" type="text"/>	Model Numbers: <input style="width: 90%; height: 20px;" type="text"/>	
Job Number: <input style="width: 90%; height: 20px;" type="text"/>		

“F” Output Range, Current Driver Models

Driver Type	Output Dimming Method	Output Voltage	Output Current	Output Power	Standards Recognition
Constant-Current Driver (Class 2)	Constant-Current Reduction (CCR)	30–54 V \approx	0.51–1.00 A	15–40 W	

Current Driver Operation Range:

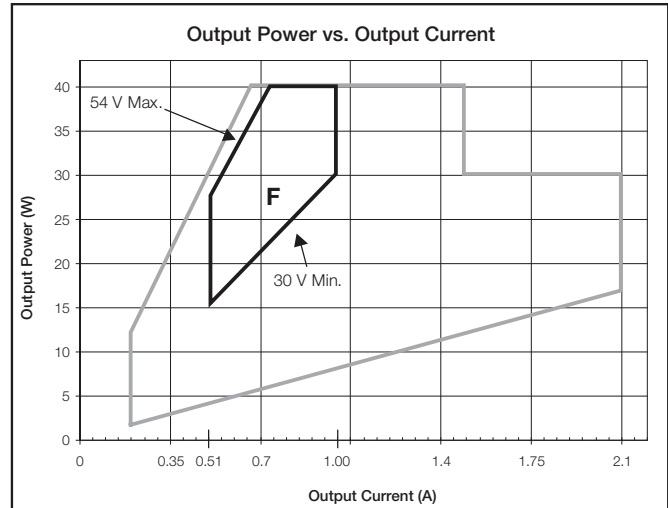
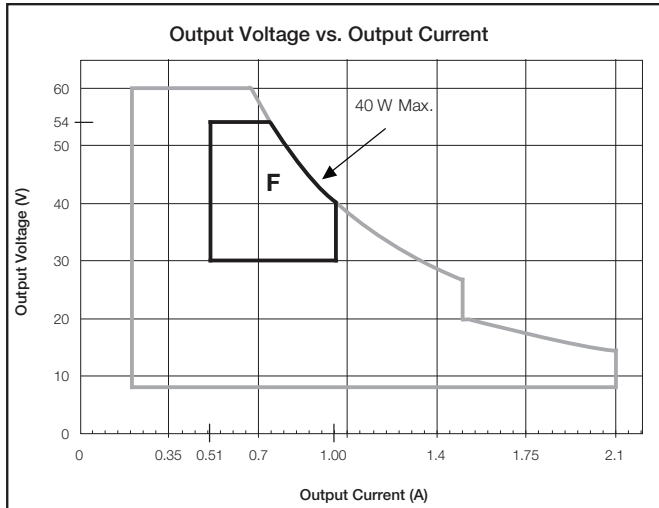

Typical Performance Specifications:

Parameter	120 V \sim	240 V \sim	277 V \sim	Test Conditions
Input Current	380 mA	200 mA	160 mA	$t_a = 25^\circ\text{C}$, 1.00 A 40 W load, Max. Light Output, K enclosure
Power Factor	0.99	0.99	0.98	
THD	8%	9%	11%	
Driver Efficiency	84%	86%	86%	

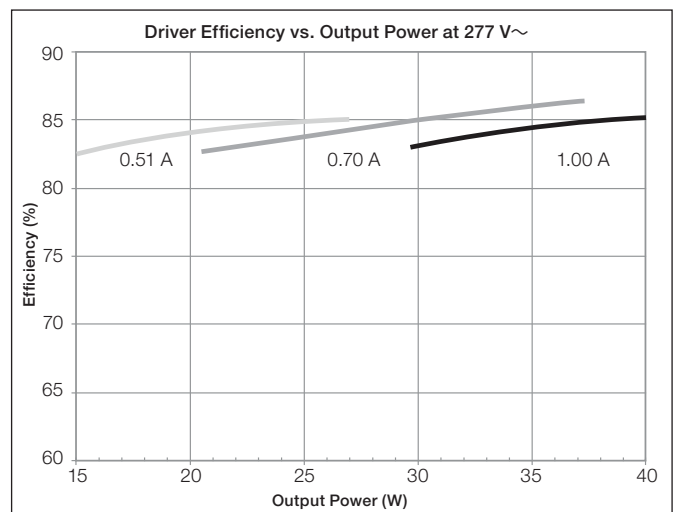
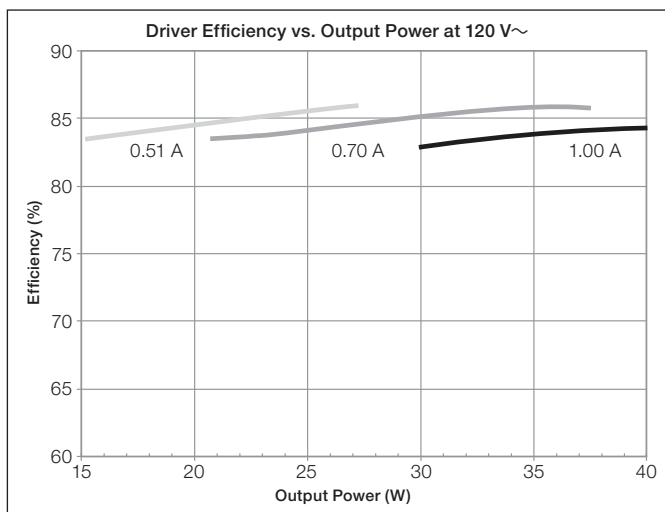

Job Name: <input style="width: 90%; height: 20px;" type="text"/>	Model Numbers: <input style="width: 90%; height: 20px;" type="text"/>	
Job Number: <input style="width: 90%; height: 20px;" type="text"/>		

“G” Output Range, Current Driver Models

Driver Type	Output Dimming Method	Output Voltage	Output Current	Output Power	Standards Recognition
Constant-Current Driver (Class 2)	Pulse Width Modulation (PWM)	8–20 V PWM	0.20–0.70 A	2–14 W	
	Constant-Current Reduction (CCR)	8–20 V=			

Current Driver Operation Range:

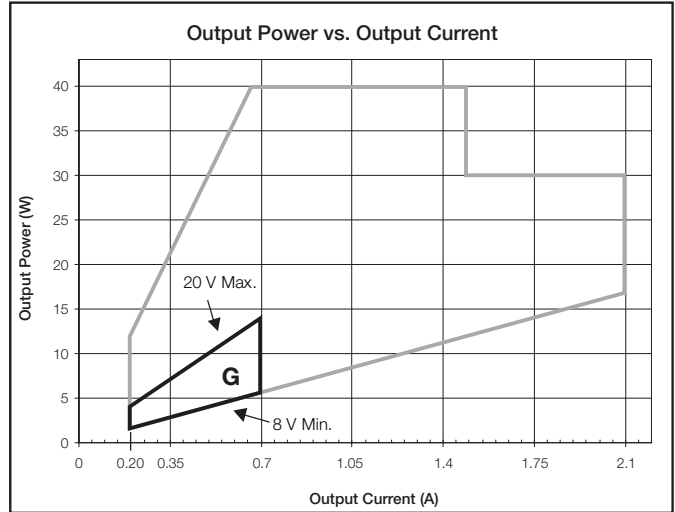
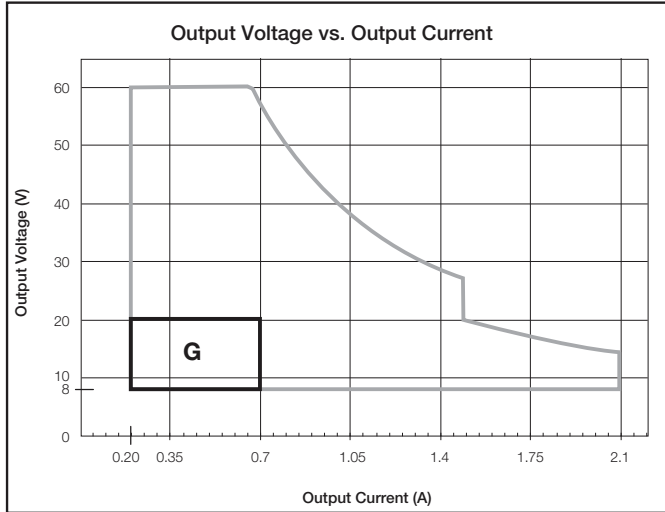

Typical Performance Specifications:

Parameter	120 V~	240 V~	277 V~	Test Conditions
Input Current	140 mA	90 mA	70 mA	$t_a = 25\text{ }^\circ\text{C}$, 0.70 A 14 W load, Max. Light Output, K enclosure
Power Factor	0.99	0.89	0.85	
THD	11%	16%	20%	
Driver Efficiency	80%	80%	79%	

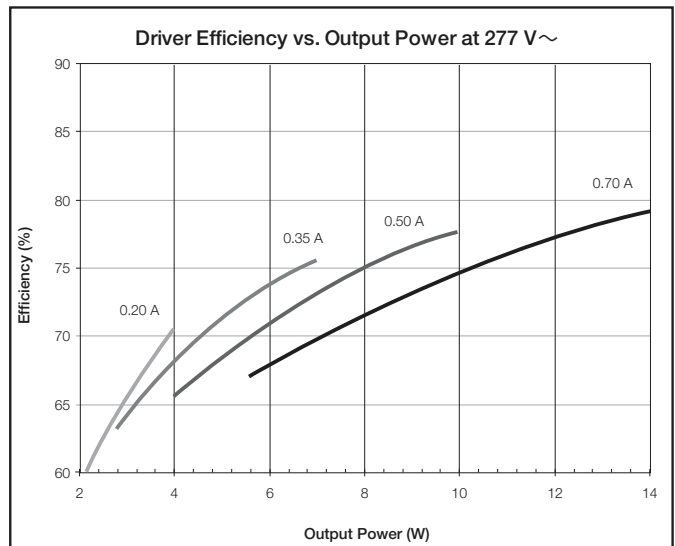
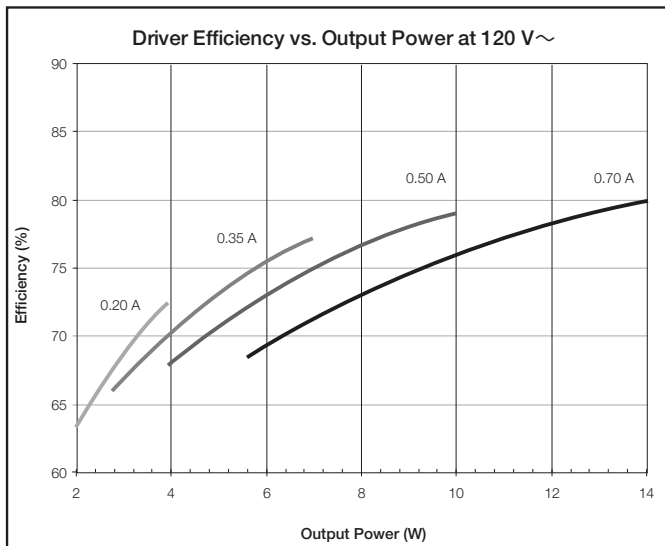

Job Name: <input style="width: 90%; height: 20px;" type="text"/>	Model Numbers: <input style="width: 90%; height: 20px;" type="text"/>	
Job Number: <input style="width: 90%; height: 20px;" type="text"/>		

“H” Output Range, Current Driver Models

Driver Type	Output Dimming Method	Output Voltage	Output Current	Output Power	Standards Recognition
Constant-Current Driver (Class 2)	Pulse Width Modulation (PWM)	15–38 V PWM	0.20–0.70 A	3–26 W	
	Constant-Current Reduction (CCR)	15–38 V---			

Current Driver Operation Range:

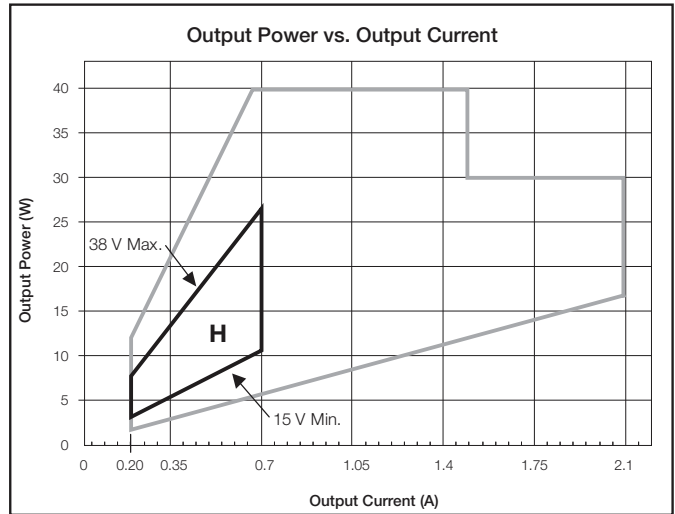
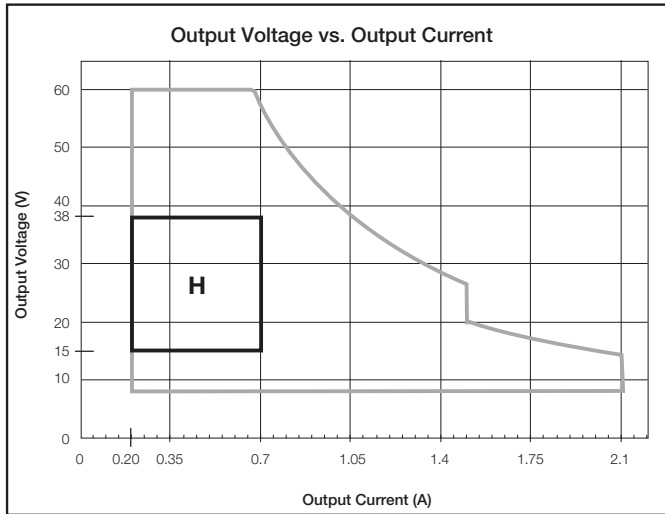

Typical Performance Specifications:

Parameter	120 V~	240 V~	277 V~	Test Conditions
Input Current	270 mA	140 mA	120 mA	$t_a = 25^\circ\text{C}$, 0.70 A 26 W load, Max. Light Output, K enclosure
Power Factor	0.99	0.96	0.94	
THD	7%	10%	12%	
Driver Efficiency	84%	85%	85%	

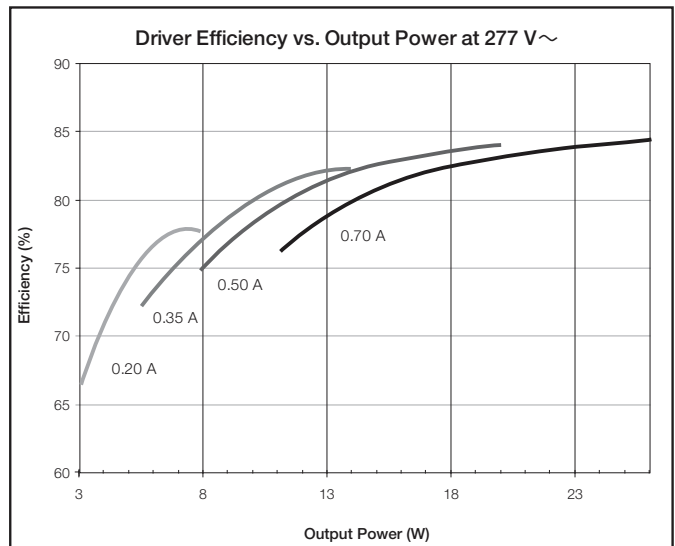
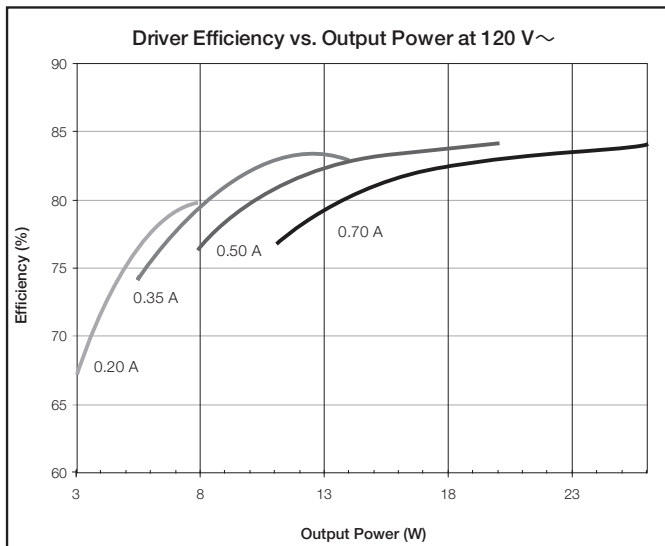

Job Name: <input style="width: 90%; height: 20px;" type="text"/>	Model Numbers: <input style="width: 95%; height: 20px;" type="text"/>
Job Number: <input style="width: 100%; height: 20px;" type="text"/>	<input style="width: 95%; height: 20px;" type="text"/>

"I" Output Range, Current Driver Models

Driver Type	Output Dimming Method	Output Voltage	Output Current	Output Power	Standards Recognition
Constant-Current Driver (Class 2)	Pulse Width Modulation (PWM)	8–20 V PWM	0.71–1.05 A	6–21 W	
	Constant-Current Reduction (CCR)	8–20 V===			

Current Driver Operation Range:

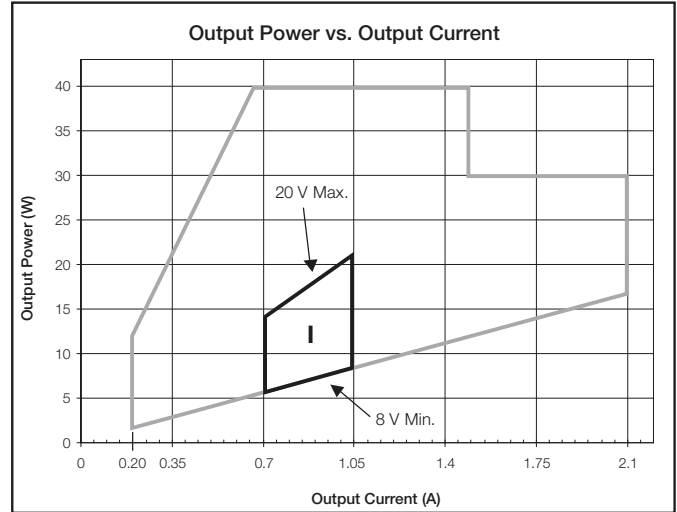
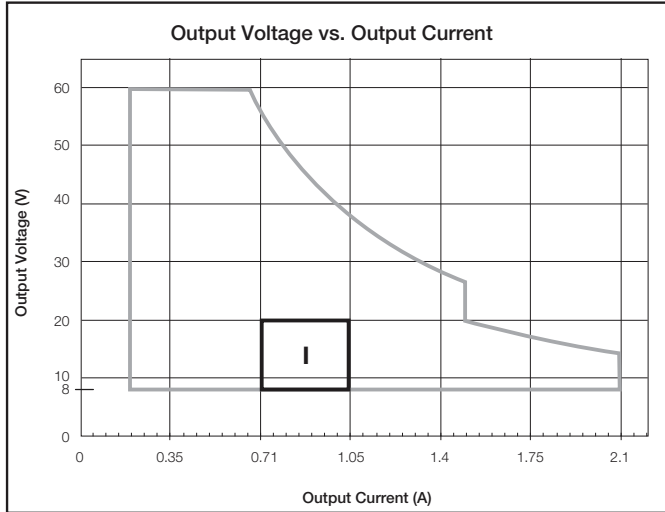

Typical Performance Specifications:

Parameter	120 V~	240 V~	277 V~	Test Conditions
Input Current	210 mA	120 mA	100 mA	$t_a = 25\text{ }^\circ\text{C}$, 1.05 A 21 W load, Max. Light Output, K enclosure
Power Factor	0.98	0.94	0.92	
THD	15%	13%	14%	
Driver Efficiency	82%	81%	81%	

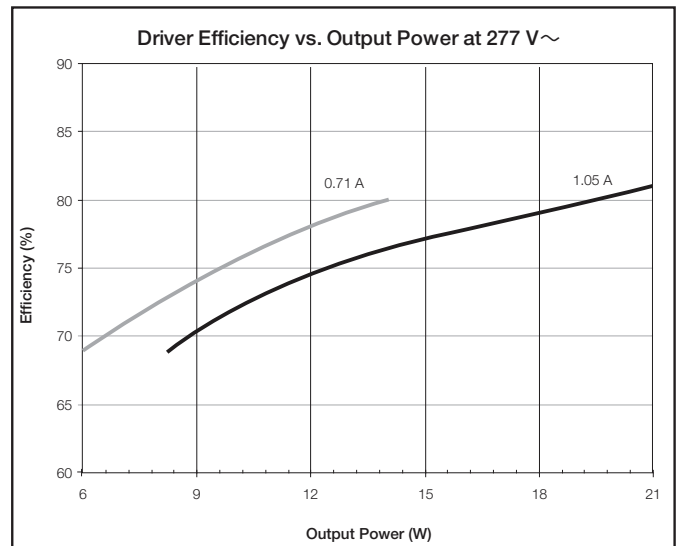
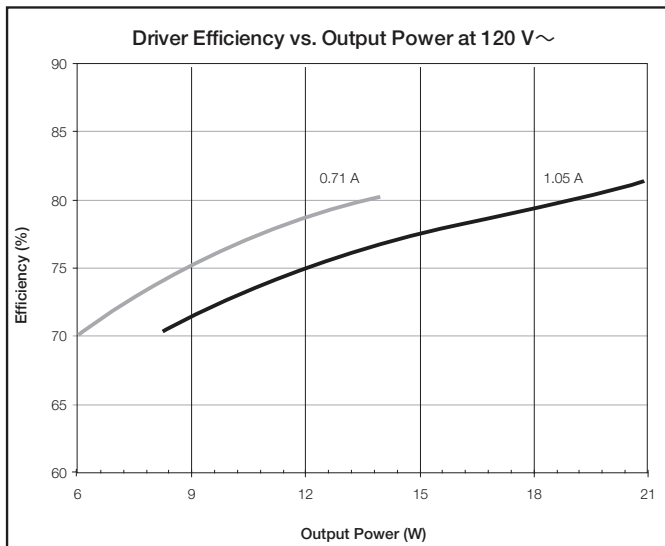

Job Name: <input style="width: 90%;" type="text"/>	Model Numbers: <input style="width: 90%;" type="text"/>	<input style="width: 90%;" type="text"/>
Job Number: <input style="width: 90%;" type="text"/>	<input style="width: 90%;" type="text"/>	<input style="width: 90%;" type="text"/>

“J” Output Range, Current Driver Models

Driver Type	Output Dimming Method	Output Voltage	Output Current	Output Power	Standards Recognition
Constant-Current Driver (Class 2)	Pulse Width Modulation (PWM)	15–38 V PWM	0.71–1.05 A	11–40 W	
	Constant-Current Reduction (CCR)	15–38 V---			

Current Driver Operation Range:

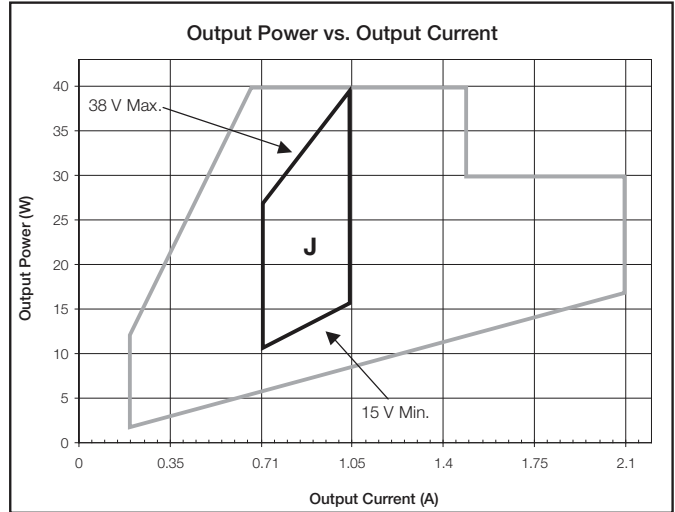
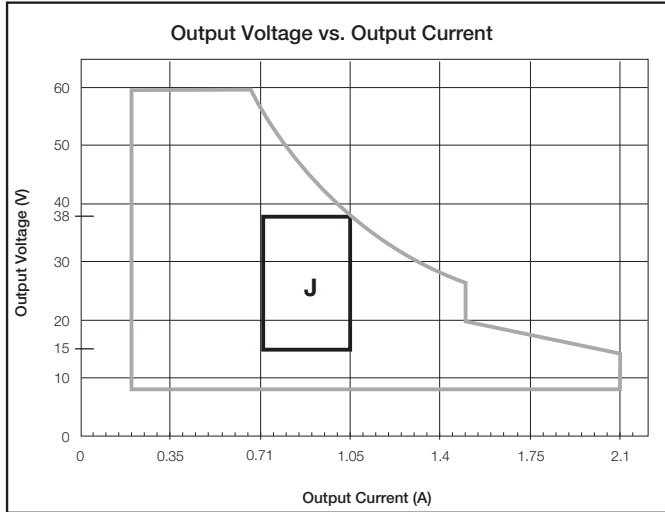

Typical Performance Specifications:

Parameter	120 V~	240 V~	277 V~	Test Conditions
Input Current	390 mA	200 mA	170 mA	$t_a = 25\text{ }^\circ\text{C}$, 1.05 A 40 W load, Max. Light Output, K enclosure
Power Factor	0.99	0.98	0.97	
THD	6%	9%	10%	
Driver Efficiency	85%	86%	86%	

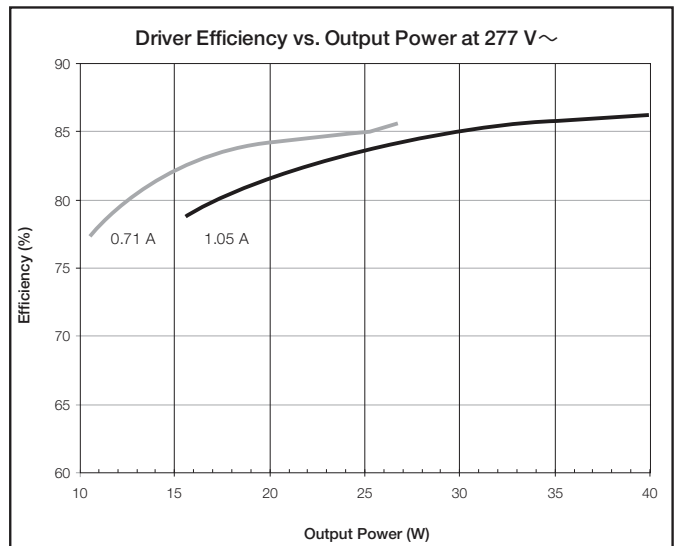
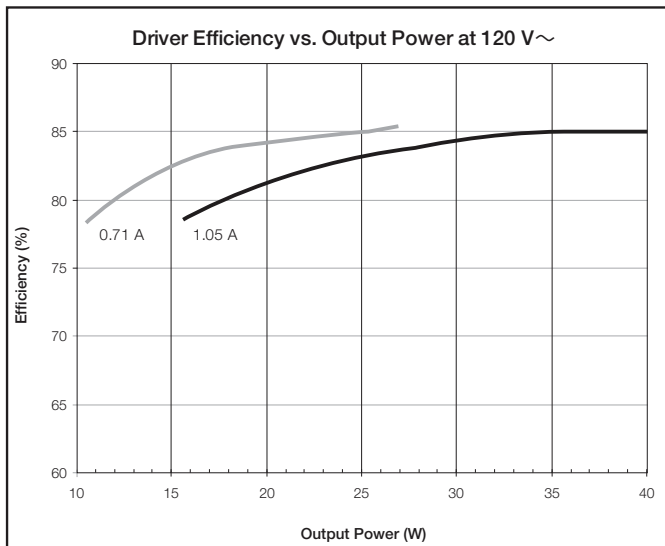

Job Name: <input type="text"/>	Model Numbers: <input type="text"/>
Job Number: <input type="text"/>	<input type="text"/>

“K” Output Range, Current Driver Models

Driver Type	Output Dimming Method	Output Voltage	Output Current	Output Power	Standards Recognition
Constant-Current Driver (Class 2)	Pulse Width Modulation (PWM)	8–20 V PWM	1.06–1.50 A	9–30 W	
	Constant-Current Reduction (CCR)	8–20 V=			

Current Driver Operation Range:

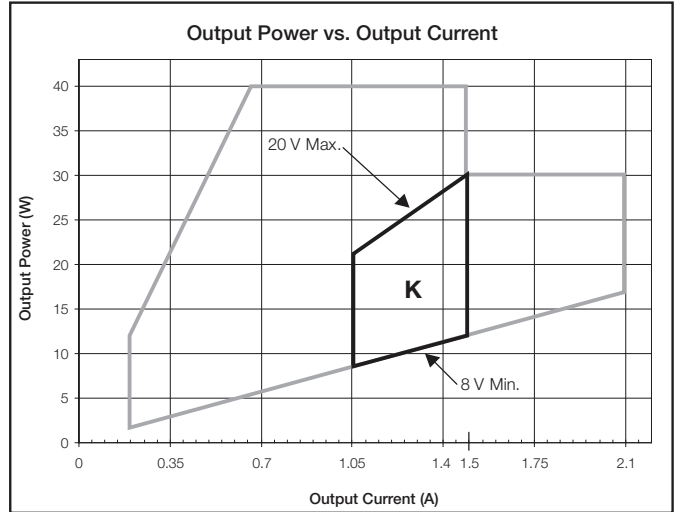
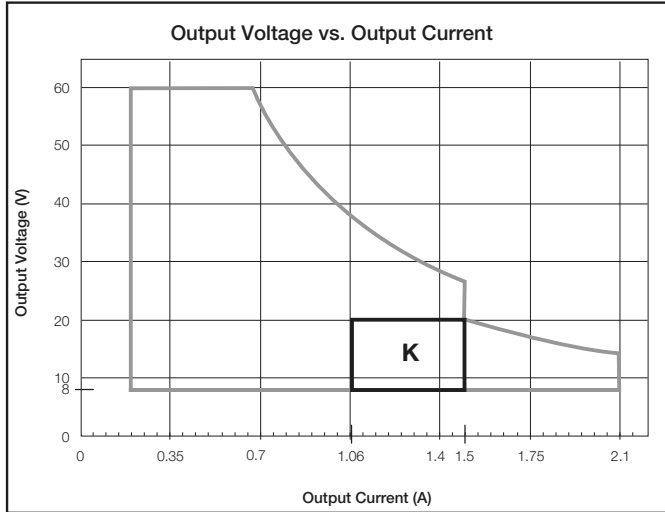

Typical Performance Specifications:

Parameter	120 V~	240 V~	277 V~	Test Conditions
Input Current	310 mA	160 mA	130 mA	$t_a = 25\text{ }^\circ\text{C}$, 1.50 A 30 W load, Max. Light Output, K enclosure
Power Factor	0.99	0.96	0.94	
THD	15%	17%	15%	
Driver Efficiency	81%	83%	82%	

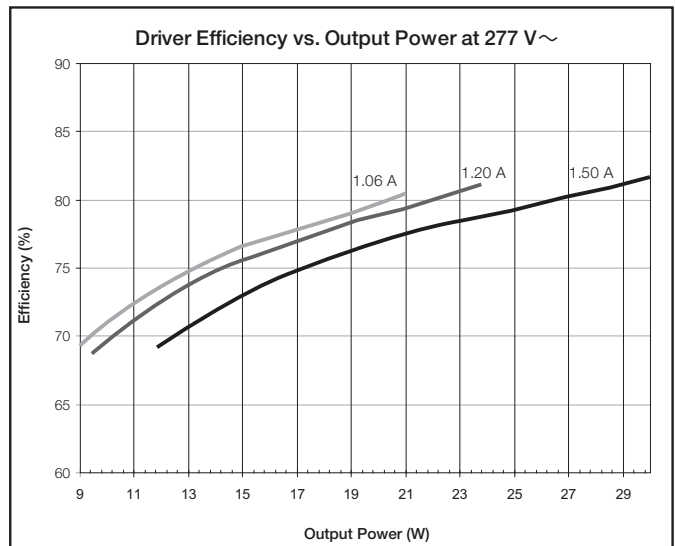
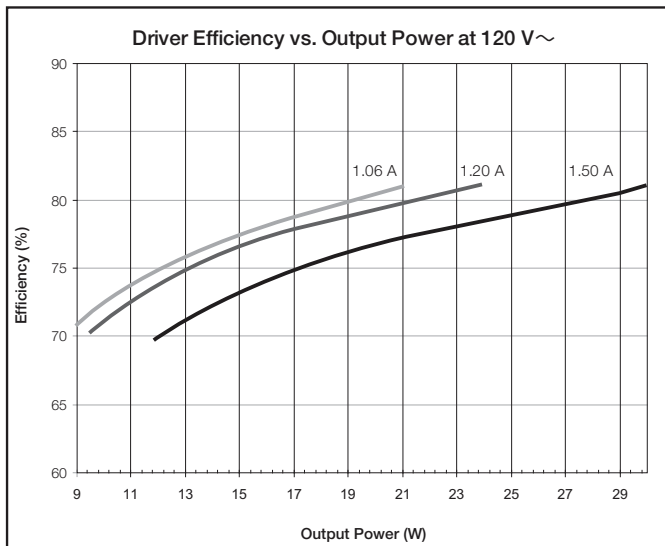

Job Name:	Model Numbers:	
<input type="text"/>	<input type="text"/>	<input type="text"/>
Job Number:	<input type="text"/>	<input type="text"/>

“L” Output Range, Current Driver Models

Driver Type	Output Dimming Method	Output Voltage	Output Current	Output Power	Standards Recognition
Constant-Current Driver (Class 2)	Pulse Width Modulation (PWM)	15–38 V PWM	1.06–1.50 A	16–40 W	
	Constant-Current Reduction (CCR)	15–38 V---			

Current Driver Operation Range:

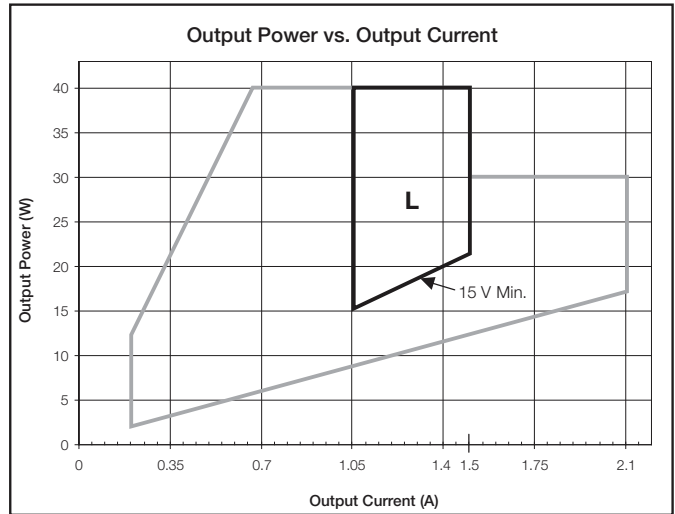
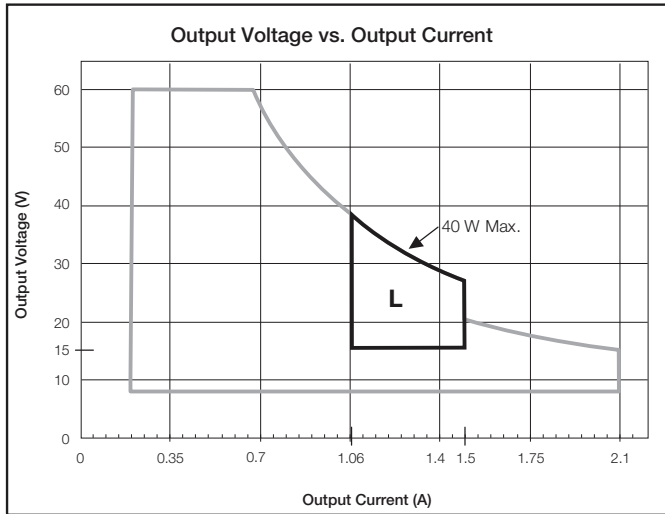

Typical Performance Specifications:

Parameter	120 V~	240 V~	277 V~	Test Conditions
Input Current	390 mA	200 mA	180 mA	$t_a = 25^\circ\text{C}$, 1.50 A 40 W load, Max. Light Output, K enclosure
Power Factor	0.99	0.97	0.96	
THD	9%	13%	12%	
Driver Efficiency	83%	85%	85%	

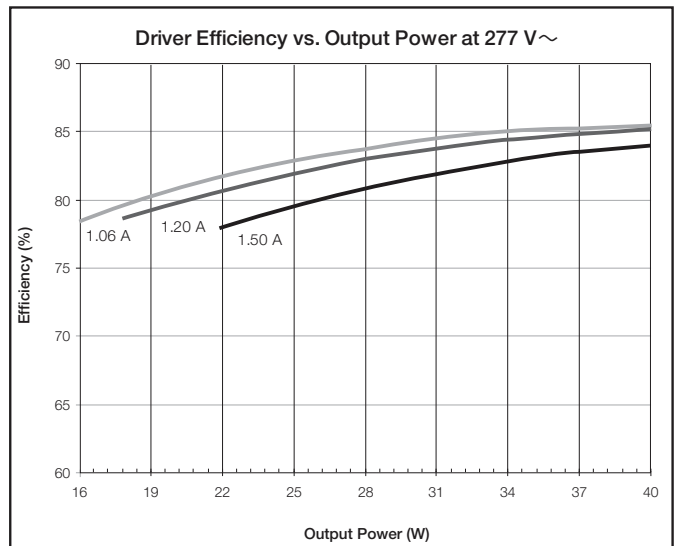
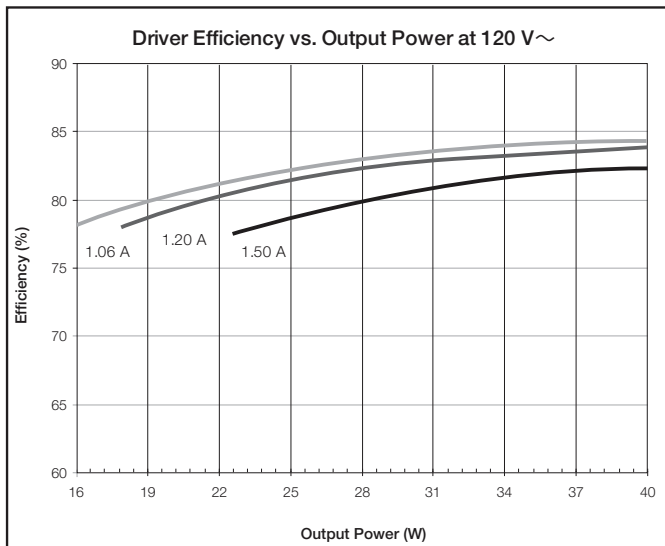

Job Name: <input style="width: 90%; height: 20px;" type="text"/>	Model Numbers: <input style="width: 90%; height: 20px;" type="text"/>	
Job Number: <input style="width: 90%; height: 20px;" type="text"/>		

“M” Output Range, Current Driver Models

Driver Type	Output Dimming Method	Output Voltage	Output Current	Output Power	Standards Recognition
Constant-Current Driver (Class 2)	Pulse Width Modulation (PWM)	8–19.9 V PWM	1.51–2.10 A	12–30 W	
	Constant-Current Reduction (CCR)	8–19.9 V=			

Current Driver Operation Range:

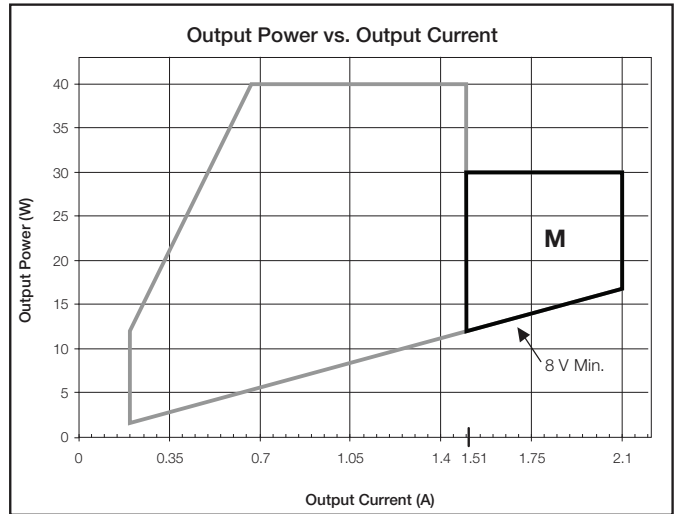
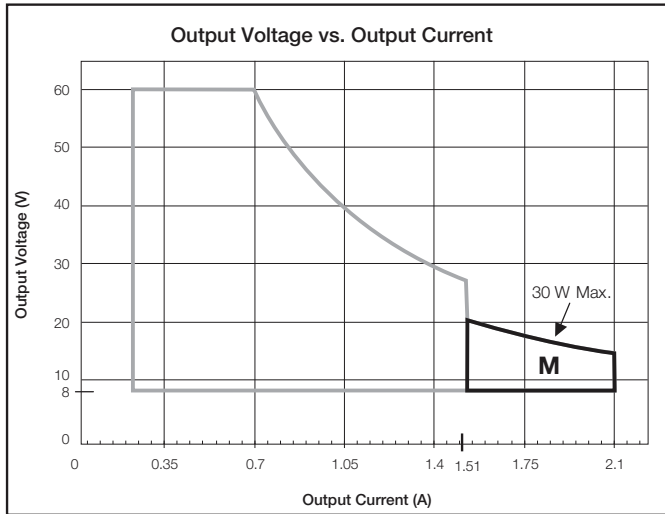

Typical Performance Specifications:

Parameter	120 V~	240 V~	277 V~	Test Conditions
Input Current	310 mA	160 mA	140 mA	$t_a = 25\text{ }^\circ\text{C}$, 2.10 A 30 W load, Max. Light Output, K enclosure
Power Factor	0.99	0.97	0.95	
THD	12%	12%	12%	
Driver Efficiency	80%	81%	81%	

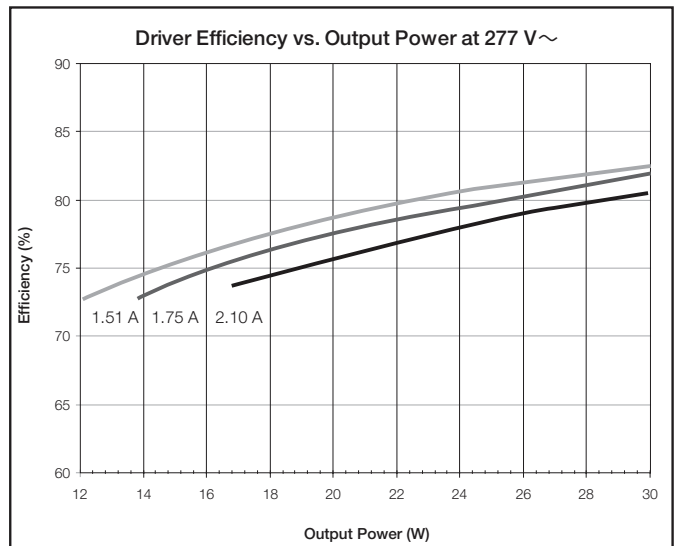
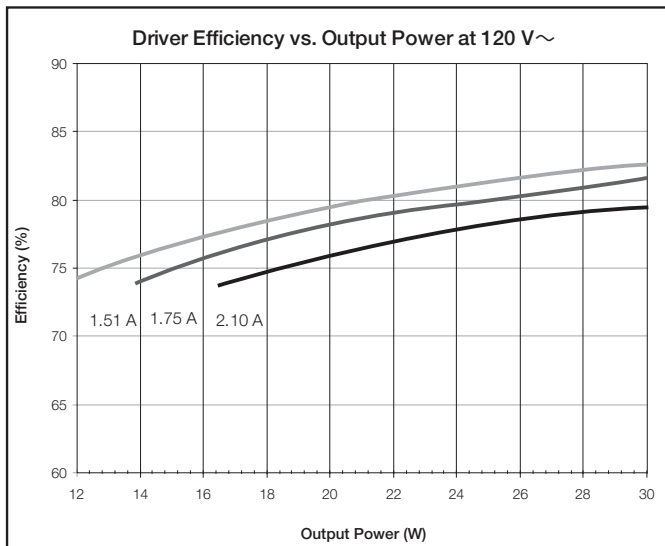

Job Name: <input style="width: 90%; height: 20px;" type="text"/>	Model Numbers: <input style="width: 90%; height: 20px;" type="text"/>	
Job Number: <input style="width: 90%; height: 20px;" type="text"/>		

“X” Output Range, Voltage Driver Models

Driver Type	Output Dimming Method	Output Voltage	Output Current	Output Power	Standards Recognition
Constant-Voltage Driver (Isolated, Non-Class 2)	Pulse Width Modulation (PWM)	38.5–60.0 V PWM	0.08–1.04 A	5–40 W	

Voltage Driver Operation Range:

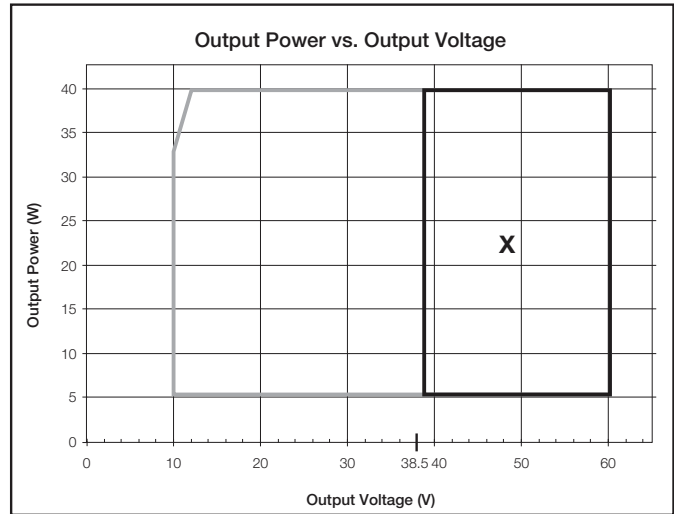
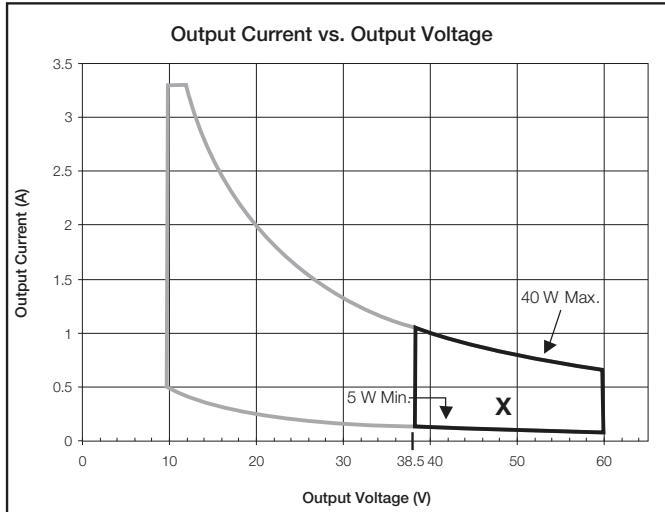

Typical Performance Specifications:

Parameter	120 V~	240 V~	277 V~	Test Conditions
Input Current	380 mA	190 mA	170 mA	t _a = 25 °C, 60.0 V 40 W load, Max. Light Output, K enclosure
Power Factor	0.99	0.99	0.98	
THD	7%	6%	8%	
Driver Efficiency	88%	89%	89%	

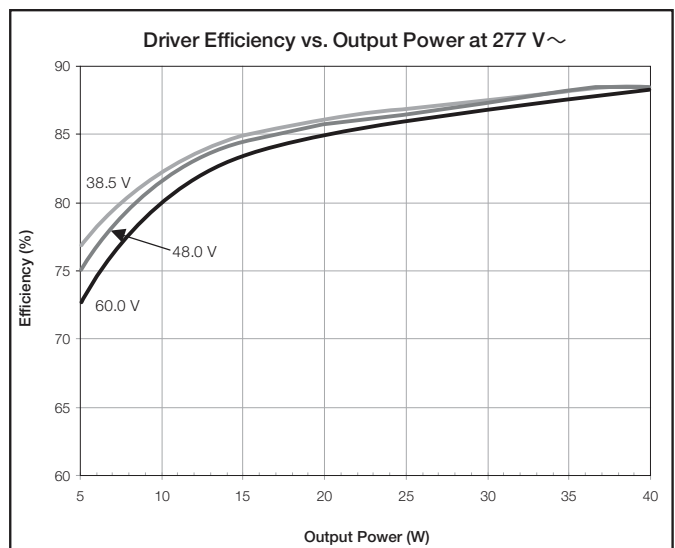
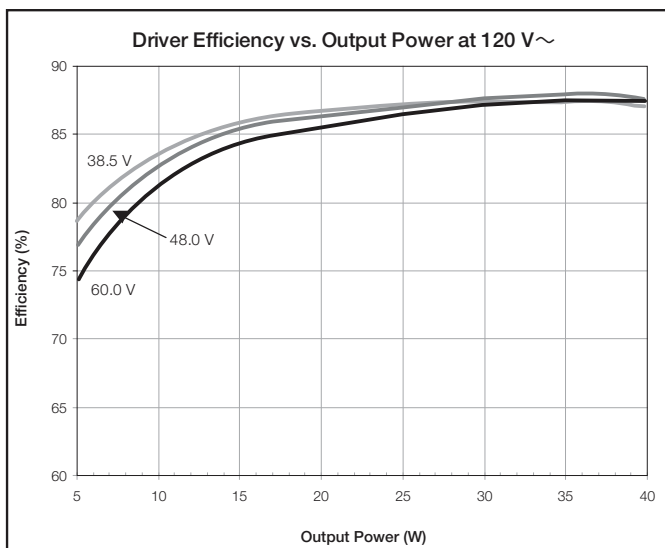

Job Name:	Model Numbers:	
<input type="text"/>	<input type="text"/>	<input type="text"/>
Job Number:	<input type="text"/>	<input type="text"/>

“Y” Output Range, Current Driver Models

Driver Type	Output Dimming Method	Output Voltage	Output Current	Output Power	Standards Recognition
Constant-Current Driver (Isolated, Non-Class 2)	Pulse Width Modulation (PWM)	30–60 V PWM	0.20–0.50 A	6–30 W	
	Constant-Current Reduction (CCR)	30–60 V---			

Current Driver Operation Range:

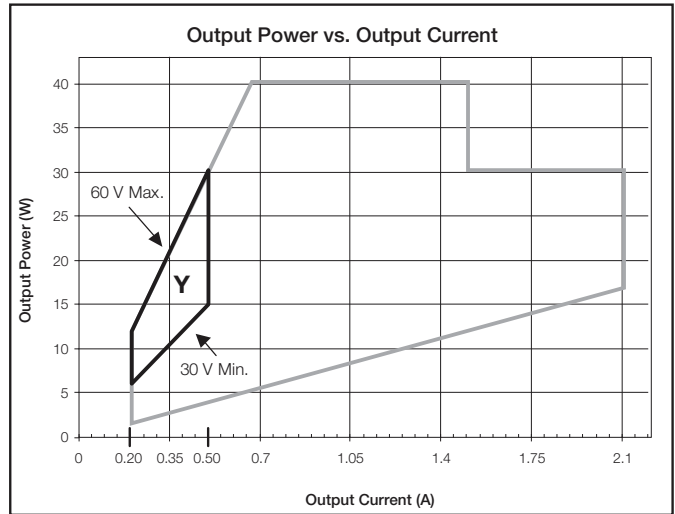
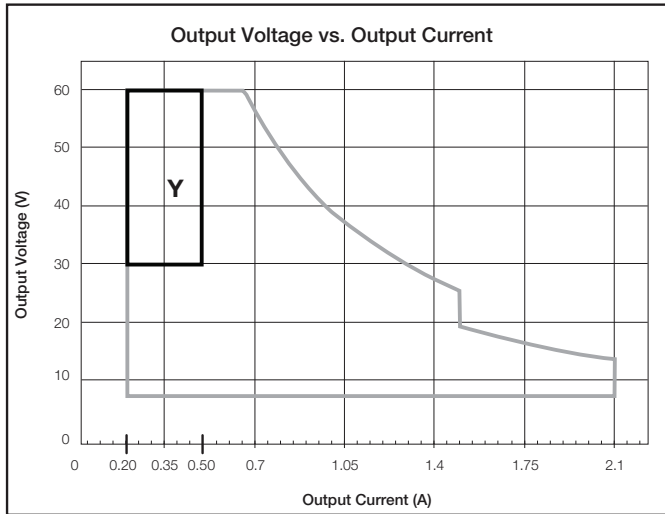

Typical Performance Specifications:

Parameter	120 V~	240 V~	277 V~	Test Conditions
Input Current	280 mA	150 mA	120 mA	$t_a = 25\text{ }^\circ\text{C}$, 0.50 A 30 W load, Max. Light Output, K enclosure
Power Factor	0.99	0.98	0.97	
THD	8%	9%	9%	
Driver Efficiency	85%	86%	86%	

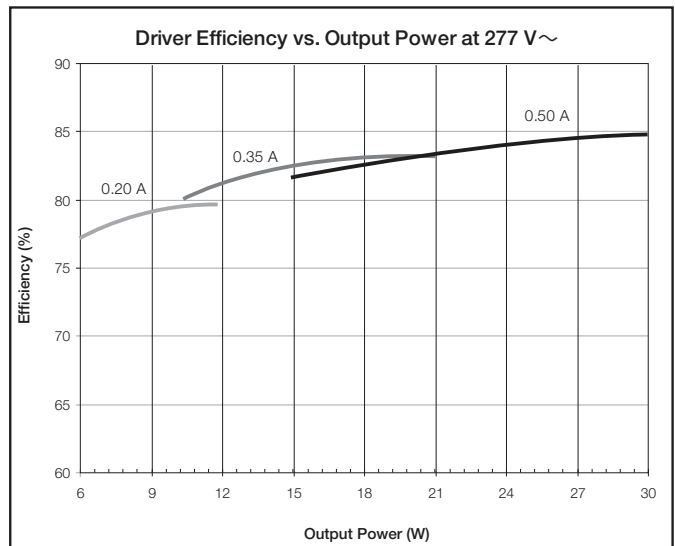
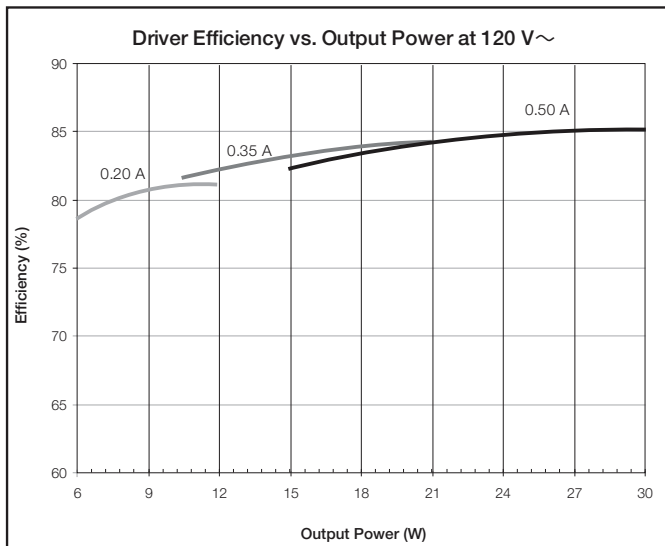

Job Name: <input style="width: 90%;" type="text"/>	Model Numbers: <input style="width: 95%;" type="text"/>
Job Number: <input style="width: 150px;" type="text"/>	<input style="width: 95%;" type="text"/>

“Z” Output Range, Current Driver Models

Driver Type	Output Dimming Method	Output Voltage	Output Current	Output Power	Standards Recognition
Constant-Current Driver (Isolated, Non-Class 2)	Pulse Width Modulation (PWM)	30–60 V PWM	0.51–1.00 A	16–40 W	
	Constant-Current Reduction (CCR)	30–60 V---			

Current Driver Operation Range:

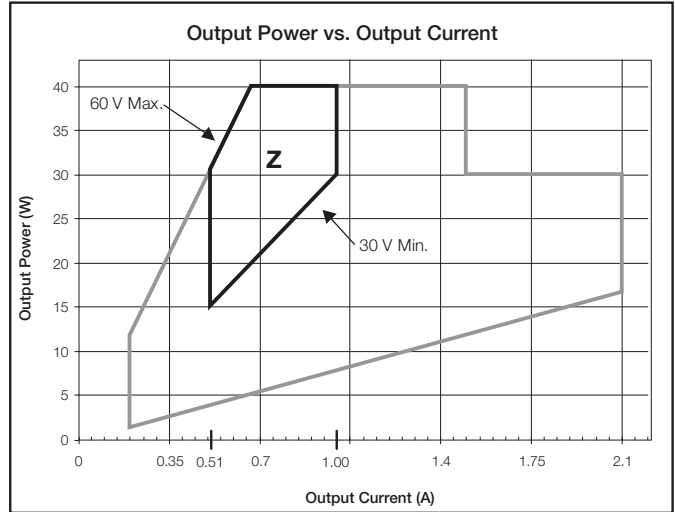
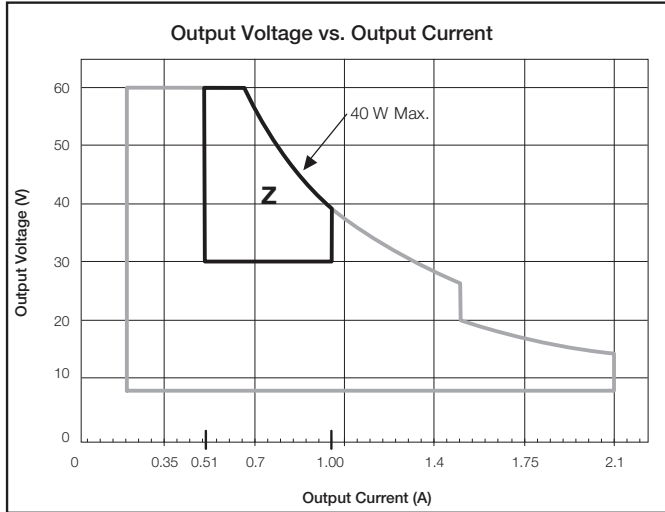

Typical Performance Specifications:

Parameter	120 V~	240 V~	277 V~	Test Conditions
Input Current	380 mA	200 mA	160 mA	$t_a = 25\text{ }^\circ\text{C}$, 1.00 A 40 W load, Max. Light Output, K enclosure
Power Factor	0.99	0.99	0.98	
THD	10%	8%	8%	
Driver Efficiency	84%	86%	86%	

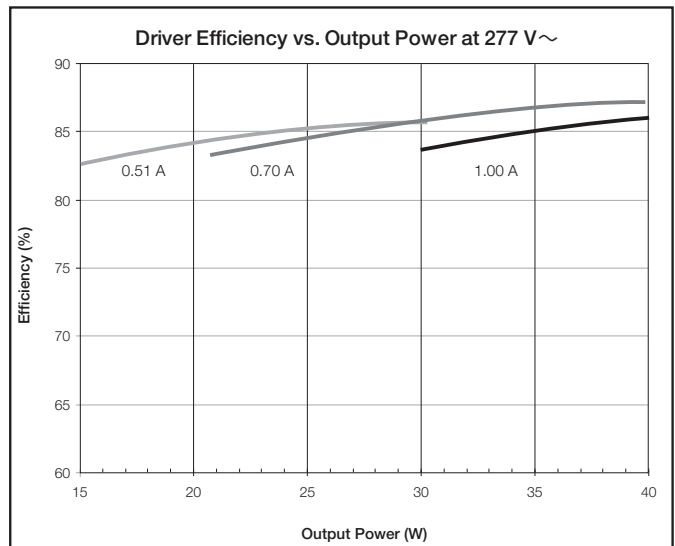
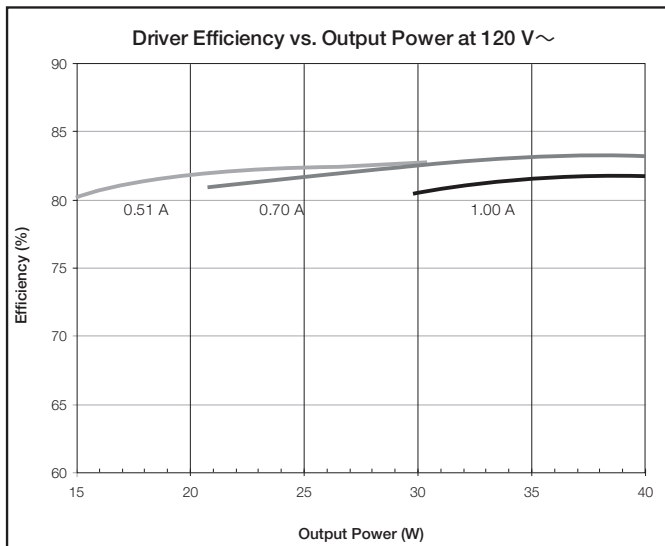

Job Name: <input style="width: 90%;" type="text"/>	Model Numbers: <input style="width: 90%;" type="text"/>	
Job Number: <input style="width: 90%;" type="text"/>		

K Case: Case Dimensions

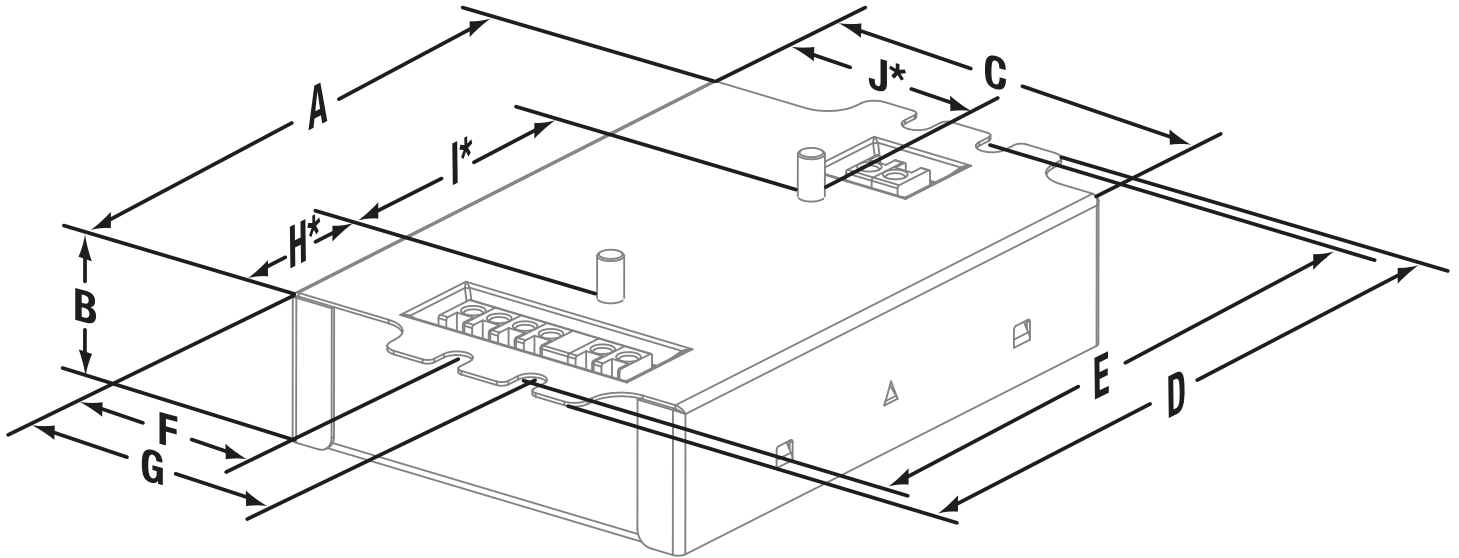

K Case: Connector Location Dimensions

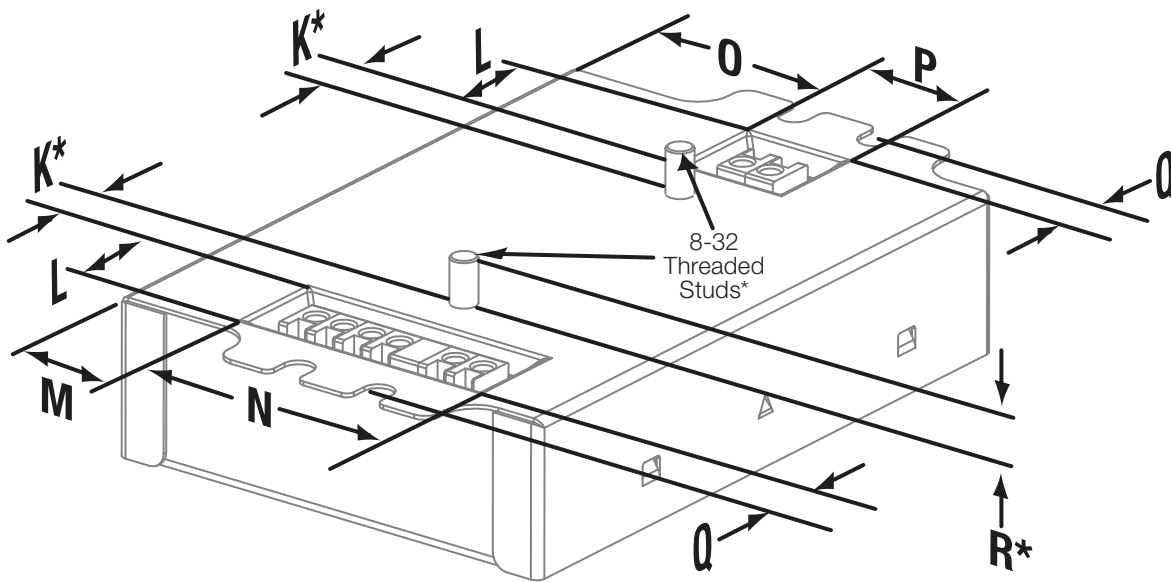

A	4.20 in (107 mm)	F	1.42 in (36 mm)	K*	0.33 in (8.3 mm)	P	0.74 in (19 mm)
B	1.00 in (25 mm)	G	1.99 in (51 mm)	L	0.65 in (16.5 mm)	Q	0.32 in (8 mm)
C	3.00 in (76 mm)	H*	1.11 in (28 mm)	M	0.75 in (19 mm)	R*	0.29 in (7 mm)
D	4.90 in (124 mm)	I*	2.00 in (51 mm)	N	1.73 in (44 mm)		
E	4.60 in (117 mm) (mounting center)	J*	1.60 in (41 mm)	O	1.33 in (34 mm)		

* Applies to studded K case only.

Job Name:	Model Numbers:	
<input type="text"/>	<input type="text"/>	<input type="text"/>
Job Number:	<input type="text"/>	<input type="text"/>

K Case: Side Entry Connector Location Dimensions (Non-Studded)

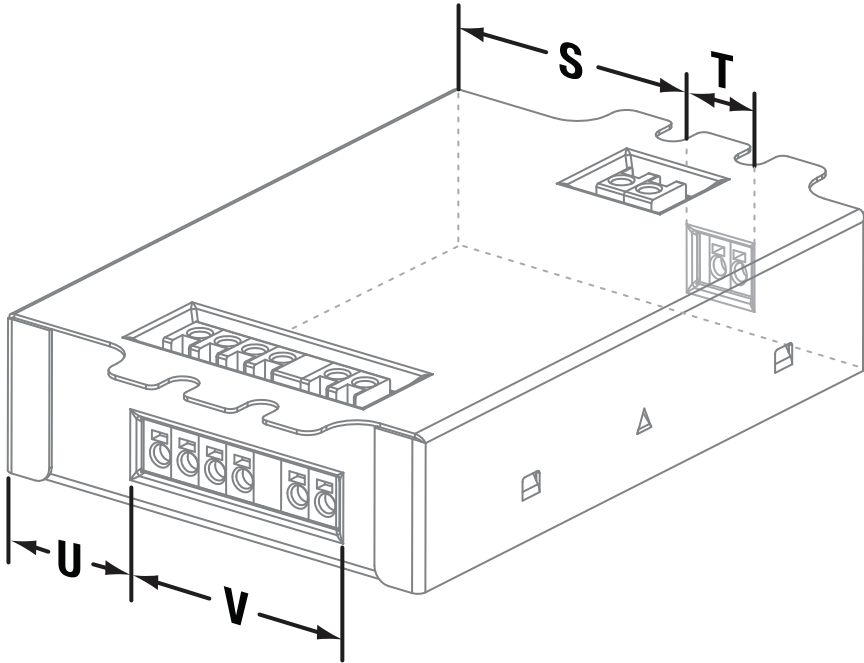

- S 1.38 in (35 mm)
- T 0.64 in (16 mm)
- U 0.88 in (22 mm)
- V 1.53 in (39 mm)

M Case: Case Dimensions

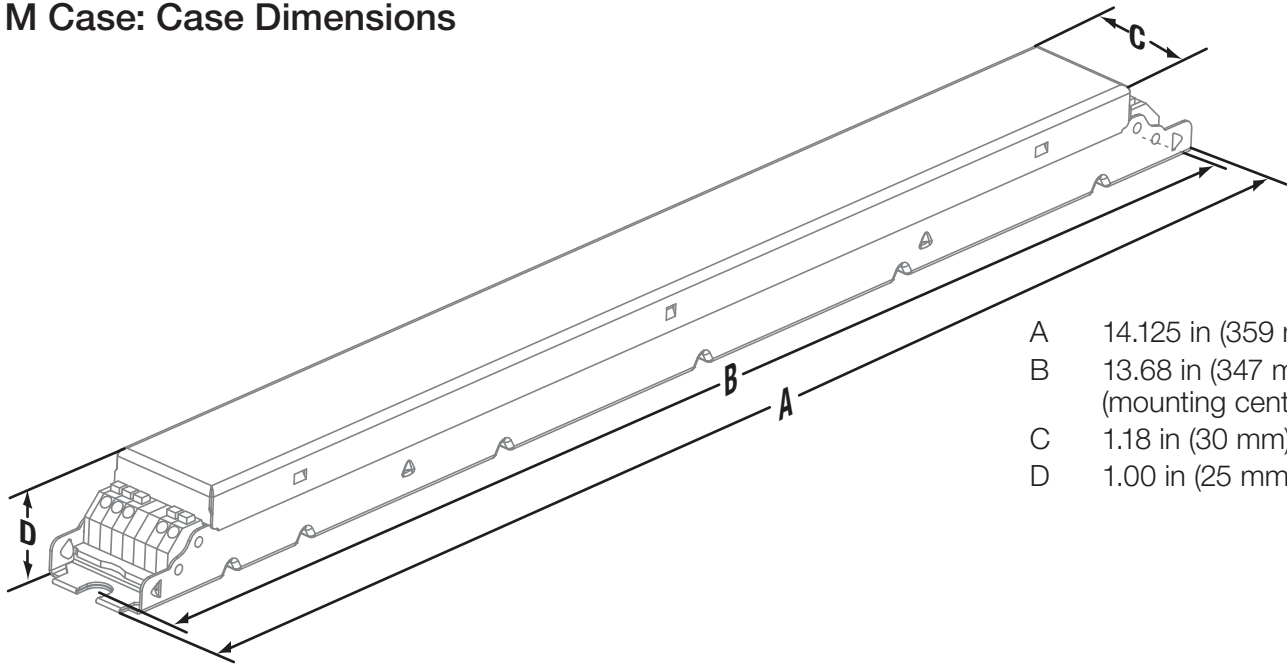

- A 14.125 in (359 mm)
- B 13.68 in (347 mm)
(mounting center)
- C 1.18 in (30 mm)
- D 1.00 in (25 mm)

Job Name: <input style="width: 90%; height: 20px;" type="text"/>	Model Numbers: <input style="width: 60%; height: 20px;" type="text"/> <input style="width: 40%; height: 20px;" type="text"/>	
Job Number: <input style="width: 100%; height: 20px;" type="text"/>	<input style="width: 100%; height: 20px;" type="text"/>	<input style="width: 100%; height: 20px;" type="text"/>

Wiring Diagram for 3-Wire Control

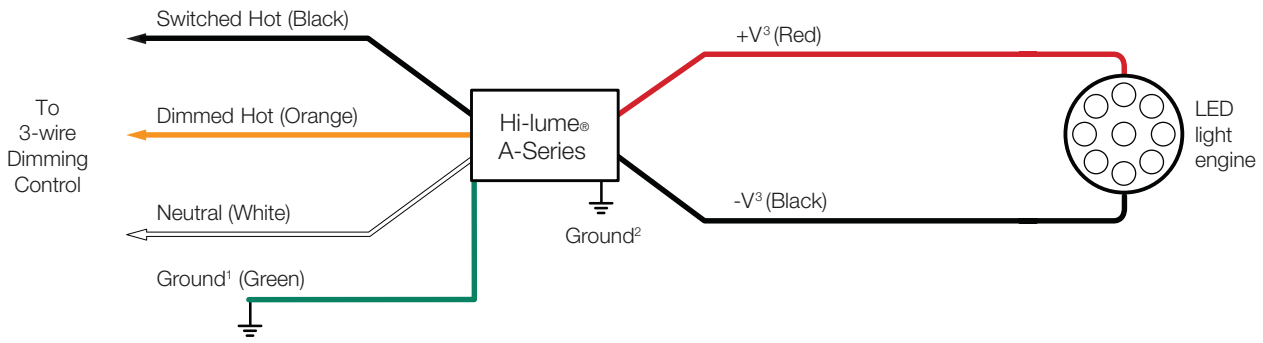

Wiring Diagram for EcoSystem® Digital Control

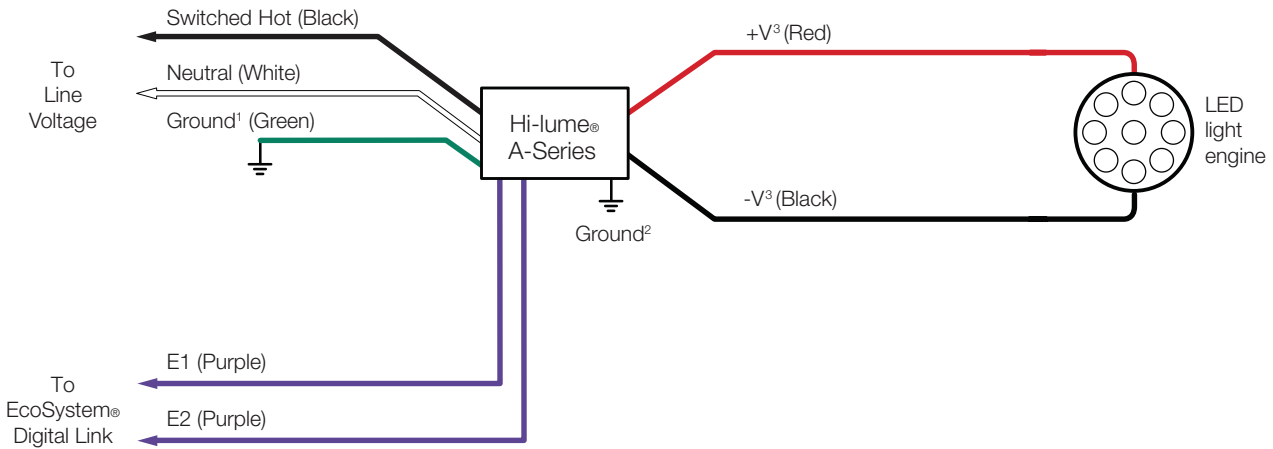

Note: Colors shown correspond to terminal blocks on driver.

¹ Ground wire connection available on K case models only.
² Fixture and driver case must be grounded in accordance with local and national electrical codes.
³ For maximum driver-to-LED light engine wire length, see charts in **Specifications—Driver Wiring & Mounting** section.

Job Name:	Model Numbers:	
<input type="text"/>	<input type="text"/>	<input type="text"/>
Job Number:	<input type="text"/>	<input type="text"/>

Compatible Controls

- Guaranteed performance specifications with the controls listed in the chart below.
- For assistance selecting controls, contact our LED Center of Excellence at 1.877.346.5338 or LEDs@lutron.com

Product	Part Number		Drivers per Control		Measured Light Output Range
	120 V~	277 V~	120 V~	277 V~	
3-wire Controls: Requires 3rd wire for control signal, see 3-wire diagram on previous page					
Nova T [☆]	NTF-10-	NTF-10-277-	1-41	1-44	100%-1%
	NTF-103P-	NTF-103P-277-	1-20	1-33	100%-1%
Nova®	NF-10-	NF-10-277-	1-41	1-44	100%-1%
	NF-103P-	NF-103P-277-	1-20	1-33	100%-1%
Vareo®	VF-10-		1-20	-	100%-1%
Skylark®	SF-10P-	SF-12P-277-	1-20	1-33	100%-1%
	SF-103P-	SF-12P-277-3	1-20	1-33	100%-1%
Diva®	DVF-103P-	DVF-103P-277-	1-20	1-33	100%-1%
	DVSCF-103P-	DVSCF-103P-277-	1-20	1-33	100%-1%
Ariadni®	AYF-103P-	AYF-103P-277-	1-20	1-44	100%-1%
Vierti®	VTF-6A-		1-15	1-33	100%-1%
Maestro®	MAF-6AM-	MAF-6AM-277-	1-15	1-20	100%-1%
	MSCF-6AM-	MSCF-6AM-277-	1-15	1-20	100%-1%
Maestro Wireless®	MRF2-F6AN-DV-		1-15	1-33	100%-1%
RadioTouch®	RTA-RX-F-		1-41	1-88	100%-1%
Spacer System®	SPSF-6A-	SPSF-6A-277-	1-15	1-20	100%-1%
	SPSF-6AM-	SPSF-6AM-277-	1-15	1-20	100%-1%
Lyneo® Lx	LXF-103PL-	LXF-103PL-277-	1-20	1-33	100%-1%
RadioRA® 2	RRD-F6AN-DV-		1-15	1-33	100%-1%
HomeWorks® QS	HQRD-F6AN-DV		1-15	1-33	100%-1%
Interfaces ¹	PHPM-3F-120		1-41	-	100%-1%
	PHPM-3F-DV		1-41	1-88	100%-1%
	GRX-FDBI-16A		1-41	1-88	100%-1%
GP Dimming Panels	Various		1-41	1-88	100%-1%
EcoSystem® Controls: See EcoSystem® Controls wiring diagram on previous page					
PowPak® dimming module with EcoSystem®	RMJ-ECO32-DV-B		32 per EcoSystem® link		100%-1%
Energi Savr Node™ with EcoSystem®	QSN-1ECO-S, QSN-2ECO-S		64 per EcoSystem® link		100%-1%
GRAFIK Eye® QS with EcoSystem®	QSGRJ-_E, QSGR-_E		64 per EcoSystem® link		100%-1%
Quantum®	Various		64 per EcoSystem® link		100%-1%

¹ For use with 3-wire controls or Commercial Systems, RadioRA® 2 Systems or Home Systems applications.

NOTE: Contact Lutron Technical Support for derating rules when using wallbox controls on the Hi-lume® A-Series LED Driver in multi-gang applications.

Job Name: <input type="text"/>	Model Numbers: <input type="text"/>	
Job Number: <input type="text"/>	<input type="text"/>	<input type="text"/>

EcoSystem® Wiring Diagrams

EcoSystem® Digital Link Overview

- The EcoSystem® Digital Link wiring (E1 and E2) connects the digital ballasts and drivers together to form a lighting control system.
- Each EcoSystem® Digital Link supports up to 64 digital ballasts, LED drivers or EcoSystem® Modules (e.g. C5-BMJ-16A, C5-XPJ-16A), 32 occupancy sensors (64 occupancy sensors with Energi Savr Node™ with EcoSystem®), 16 daylight sensors, and 64 wallstations or IR receivers.*
- Sensors do not directly connect to Hi-lume® A-Series LED drivers.
- E1 and E2 (EcoSystem® digital link wires) are polarity insensitive and can be wired in any topology.
- An Energi Savr Node™ unit with EcoSystem®, GRAFIK Eye® QS control unit with EcoSystem®, PowPak® dimming module with EcoSystem®, or Quantum® system provides power for the EcoSystem® Digital Link and supports system programming.*
- All EcoSystem® Digital Link programming is completed by using the Energi Savr app for *Apple iPad*, *iPod Touch* or *iPhone* mobile digital devices, GRAFIK Eye® QS with EcoSystem®, PowPak® dimming module with EcoSystem®, or Quantum® system.

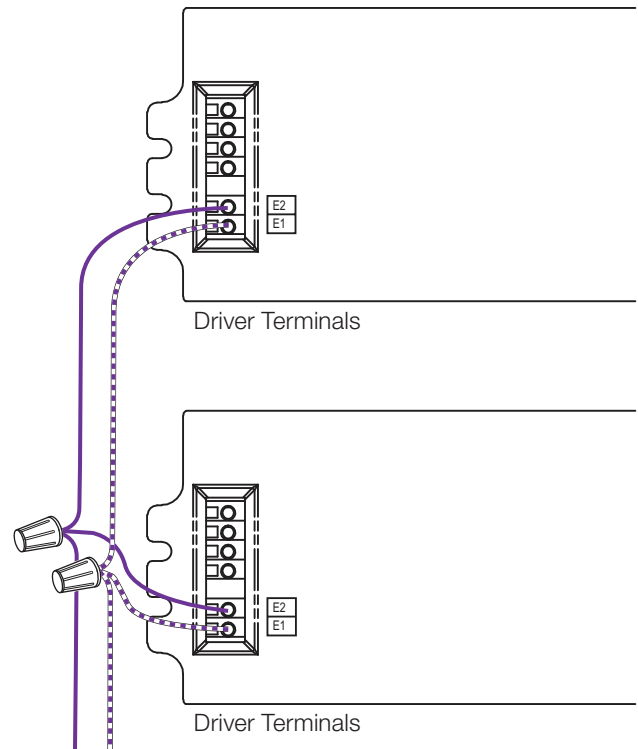

To the EcoSystem® Digital Bus and additional drivers and/or ballasts

EcoSystem® Digital Link Wiring

- Driver EcoSystem® Digital Link terminals only accept one 18 to 16 AWG (0.75 to 1.5 mm²) solid copper wire per terminal.
- Make sure that the supply breaker to the Digital Driver and EcoSystem® Digital Link Supply is OFF when wiring.
- Connect the two conductors to the two Digital Driver terminals E1 and E2 as shown.
- Using two different colors for E1 and E2 will reduce confusion when wiring several drivers together.
- The EcoSystem® Digital Link may be wired Class 1 or Class 2. Consult applicable electrical codes for proper wiring practices.

* PowPak® dimming module with EcoSystem® provides power for the EcoSystem® Digital Link and can support 32 digital ballasts, LED drivers or EcoSystem® Modules, 6 Wireless Occupancy Sensors, 1 Wireless Daylight Sensor, and 9 Pico® Wireless Controllers.

Apple, iPad, iPod Touch, and iPhone are trademarks of Apple Inc., registered in the U.S. and other countries.

Notes

- The EcoSystem® Digital Link Supply does not have to be located at the end of the Digital Link.
- EcoSystem® Digital Link length is limited by the wire gauge used for E1 and E2 as follows:

Wire Gauge	Digital Link Length (max)
12 AWG	2200 ft
14 AWG	1400 ft
16 AWG	900 ft
18 AWG	550 ft

Wire Size	Digital Link Length (max)
4.0 mm ²	828 m
2.5 mm ²	517 m
1.5 mm ²	310 m
1.0 mm ²	207 m
0.75 mm ²	155 m

Job Name:	Model Numbers:	
<input type="text"/>	<input type="text"/>	<input type="text"/>
Job Number:	<input type="text"/>	<input type="text"/>

ELECTRICIANS AND CONTRACTORS**Driver Leads**

Maximum driver-to-LED light engine wire length for

Constant-Current Drivers:

Wire Gauge	Maximum Lead Length		
	200 mA to 700 mA	710 mA to 1.50 A	1.51 A to 2.10 A
18 AWG (0.75 mm ²)	30 ft (9 m)	15 ft (4.5 m)	10 ft (3 m)
16 AWG (1.5 mm ²)	35 ft (10.5 m)	25 ft (7.5 m)	15 ft (4.5 m)
14 AWG (2.5 mm ²)	50 ft (15 m)	40 ft (12 m)	25 ft (7.5 m)
12 AWG (4.0 mm ²)	100 ft (30 m)	60 ft (18 m)	40 ft (12 m)

Maximum driver-to-LED light engine wire length for

Constant-Voltage Drivers:

Wire Gauge	Maximum Lead Length		
	10 V to 20 V	20.5 V to 40 V	40.5 V to 60 V
18 AWG (0.75 mm ²)	10 ft (3 m)	15 ft (4.5 m)	30 ft (9 m)
16 AWG (1.5 mm ²)	15 ft (4.5 m)	25 ft (7.5 m)	50 ft (15 m)
14 AWG (2.5 mm ²)	25 ft (7.5 m)	40 ft (12 m)	75 ft (22.5 m)
12 AWG (4.0 mm ²)	40 ft (12 m)	60 ft (18 m)	100 ft (30 m)

Wiring and Grounding

Driver and lighting fixture must be grounded.
Drivers must be installed per national and local electrical codes.

LED Load Replacement

For Class 2 rated drivers, the LED load can be changed while the driver is installed and powered.

Maximum Driver Operating Temperature

Driver case temperature (t_c) must not exceed UL conditions of acceptability in end product.

For 50,000 hour lifetime, driver case temperature (t_c) must not exceed 65 °C.

FACILITIES MANAGERS**SERVICE****Warranty**

For warranty information, please visit <http://www.lutron.com/TechnicalDocumentLibrary/Ballast%20and%20Driver%20Warranty.pdf>

Replacement Parts

When ordering Lutron® replacement parts please provide the full model number. Consult Lutron if you have any questions.

Further Information

For further information, please visit us at www.lutron.com/hilumeLED or contact our LED Control Center of Excellence at 1.877.346.5338 or LEDs@lutron.com

Job Name: <input type="text"/>	Model Numbers: <input type="text"/>	
Job Number: <input type="text"/>	<input type="text"/>	<input type="text"/>