

Hi-lume® A-Series Driver Overview EcoSystem® or 3-wire control

Hi-lume® A-Series Driver is a high-performance LED driver that provides smooth, continuous 1% dimming for virtually any LED fixture, whether it requires constant-current or constant-voltage. It is the most versatile LED driver offered today due to its compatibility with a wide variety of LED arrays, multiple form factors, and numerous control options.

Features

- Continuous, flicker-free dimming from 100% to 1%.
- Compatible with Energi Savr Node™ unit with EcoSystem®, GRAFIK Eye® QS control unit, PowPak® dimming module with EcoSystem®, and Quantum® systems, allowing for integration into a planned or existing EcoSystem® lighting control solution. Please see **Compatible Controls** chart or contact Lutron for details regarding compatible controls.
- Standard 3-wire, line-voltage phase-control technology for consistent dimming performance and compatibility with all Lutron® 3-wire fluorescent controls.
- QwikFig™ compatible. For more information please refer to Lutron® P/N 041473 (K and M case only).
- Line voltage miswire protection on EcoSystem® control inputs.
- 100% performance tested at factory.
- A rated lifetime of 50,000 hours @:
 - $t_c = 149\text{ °F}$ (65 °C) for 40 W drivers
 - $t_c = 158\text{ °F}$ (70 °C) for 50 W drivers
- UL® recognized for United States and Canada.
- Type TL Rated.
- FCC Part 15 compliant for commercial applications at 120 V~ or 277 V~.
- Pulse Width Modulation (PWM) or Constant-Current Reduction (CCR) dimming methods available. See Application Note #360 for details.
- RoHS Compliant.
- For more information please go to: www.lutron.com/HilumeLED



Hi-lume® A-Series, case type K

3.00 in (76 mm) W x 1.00 in (25 mm) H x 4.90 in (124 mm) L



Hi-lume® A-Series, case type M

1.18 in (30 mm) W x 1.00 in (25 mm) H x 14.25 in (362 mm) L



Hi-lume® A-Series, case type KL

K-case mounted on a 4.00 in (102 mm) W x 1.50 in (38 mm) H x 4.00 in (102 mm) L junction box to provide UL® listed wiring compartment

The Hi-lume® A-Series family of drivers includes models which operate at a maximum power of 40 W or less as well as models which can operate up to 50 W.

- 40 W or less models - output ranges A-M and X-Z
- 50 W models - output ranges N and W (K-case only)

For a description of the output ranges please see following pages.

LUTRON® SPECIFICATION SUBMITTAL

Page

Job Name:

Model Numbers:

Job Number:

Specifications

Regulatory Approvals

- Meets ANSI C62.41 category A surge protection standards up to and including 4 kV.
- FCC Part 15 compliant for commercial applications at 120 V \sim or 277 V \sim .
- Manufacturing facilities employ ESD reduction practices that comply with the requirements of ANSI/ESD S20.20.
- Lutron® Quality Systems registered to ISO 9001.2008.
- UL® 8750 recognized.
- UL® 8750 listed form factor available.
- Class 2 output available.
- Models available to meet LED Driver requirements for Energy Star 1.1.
- Type TL Rated.

UL® 8750 Listed Option

- cULus® for United States and Canada available for certain operating regions.
- Pre-wired and installation ready.
- See **KL Enclosure** page for more specific details regarding UL® listed option.

Environmental

- Sound Rating: Inaudible in 27 dB ambient.
- Relative Humidity: Maximum 90% non-condensing.
- Minimum operating ambient temperature $t_a = 32\text{ }^\circ\text{F}$ ($0\text{ }^\circ\text{C}$).

Performance

- Dimming Range: 100% to 1%.
- Operating Voltage: 120–277 V \sim at 50/60 Hz.
- Lifetime: 50,000 hours @:
 - $t_c = 149\text{ }^\circ\text{F}$ ($65\text{ }^\circ\text{C}$)¹ for 40 W drivers.
 - $t_c = 158\text{ }^\circ\text{F}$ ($70\text{ }^\circ\text{C}$)¹ for 50 W drivers.
 - For rated warranty, t_c not to exceed the maximum rated temperatures listed here.¹
- Patented thermal foldback protection.
- LEDs turn on to any dimmed level without going to full brightness.
- Non-volatile memory restores all driver settings after power failure.
- Power Factor: >0.90 for loads greater than 25 W
- Standby Power Consumption: < 1.0 W
- Total Harmonic Distortion (THD): <20% for loads greater than 25 W.
- Inrush Current: < 2 A.
- Inrush Current Limiting Circuitry: eliminates circuit breaker tripping, switch arcing and relay failure.
- Open circuit protected.
- Short circuit protected.
- Turn-on time: ≤ 1.5 seconds.²
- PWM Dimming Frequency: 550 Hz.

Driver Wiring & Mounting

- Driver is grounded by a mounting screw to the grounded fixture (or by terminal connection on the K-case).
- Terminal blocks on the driver accept one solid wire per terminal from 18 AWG to 16 AWG (0.75 mm^2 to 1.5 mm^2).
- Fixture must be grounded in accordance with local and national electrical codes.
- For maximum driver to LED light engine wire lengths see **Driver Leads** section at end of document.

¹ Installer is responsible for ensuring that the driver case temperature does not exceed the maximum rated temperature.

² Models available with turn-on time ≤ 1 second.

Job Name: Job Number:	Model Numbers:
----------------------------------	----------------

How to Build a Model Number: Hi-lume® A-Series

L3DA U1U

Maximum Power:
 4 = 40 W maximum
 5 = 50 W maximum
 (K-case only)

Case Size:
 K = Compact
 M = Stick

Case Style:
 S = Studded
 (K case only)
 N = Non-Studded
 L = UL® Listed
 (K case only)

Example: L3DA4U1UKS-HC070
 For further assistance selecting your model number, contact our LED Center of Excellence at 1.877.346.5338 or LEDs@lutron.com

Current Level (for Constant-Current):
 020 = 0.20 A; 021 = 0.21 A . . . 070 = 0.70 A . . . 210 = 2.10 A

Voltage Level (for Constant-Voltage):
 100 = 10.0 V; 105 = 10.5 V . . . 600 = 60.0 V

Driver Output:
 C = Constant-current driver
 with pulse width modulation (PWM) dimming
 A = Constant-current driver
 with constant-current reduction (CCR) dimming
 V = Constant-voltage driver
 with pulse width modulation (PWM) dimming

LED Load Output Range (see the following pages for more detail):

<p>40 W Drivers</p> <p><u>Class 2 Constant-Voltage</u></p> <p>A = 10.0 V–12.0 V B = 12.5 V–20.0 V* C = 20.5 V–24.0 V* D = 24.5 V–38.0 V*</p> <p><u>Isolated Non-Class 2 Constant-Voltage</u></p> <p>X = 38.5 V–60.0 V*</p>	<p><u>Class 2 Constant-Current</u></p> <p>E = 0.20 A–0.50 A 30 V–54 V F = 0.51 A–1.00 A 30 V–54 V* G = 0.20 A–0.70 A 8 V–20 V H = 0.20 A–0.70 A 15 V–38 V I = 0.71 A–1.05 A 8 V–20 V J = 0.71 A–1.05 A 15 V–38 V K = 1.06 A–1.50 A 8 V–20 V L = 1.06 A–1.50 A 15 V–38 V* M = 1.51 A–2.10 A 8 V–19.9 V*</p> <p><u>Isolated Non-Class 2 Constant-Current</u></p> <p>Y = 0.20 A–0.50 A 30 V–60 V Z = 0.51 A–1.00 A 30 V–60 V*</p>	<p>50 W Drivers</p> <p><u>Class 2 Constant-Current</u></p> <p>N = 0.71 A–1.05 A 35 V–54 V*</p> <p><u>Isolated Non-Class 2 Constant-Current</u></p> <p>W = 0.71 A–1.05 A 35 V–60 V*</p>
--	---	---

* Output parameter is power-limited for these output ranges. Consult detailed specifications on the following pages for each range.

LUTRON® SPECIFICATION SUBMITTAL Page

Job Name:	Model Numbers:
Job Number:	

How to Build a Bulk Model Number (For use with Lutron® QwikFig™ technology): Hi-lume® A-Series

40 W Drivers

L3DA4U1U - BLK

Case Size:

K = Compact
M = Stick

Case Style:¹

S = Studded
(K-case only)
N = Non-Studded
(All M-case models)

Bulk Models:

Coverage based on “LED Load Output Range” from standard non-configurable models shown in the **How to Build a Model Number** section.

Example Standard model number: L3DA4U1UKS-HC070 has LED load output range = H

K-case and M-case

1A = Covers “LED Load Output Range” Y and Z

2A = Covers “LED Load Output Range” M

3A = Covers “LED Load Output Range” E and F (CCR dimming only)

K-case only

2G = Covers “LED Load Output Range” G

2H = Covers “LED Load Output Range” H

2R = Covers “LED Load Output Range” I and K

2S = Covers “LED Load Output Range” J and L

M-case only

2B = Covers “LED Load Output Range” H, J, and L

2C = Covers “LED Load Output Range” G, I, and K

50 W Drivers

L3DA5U1UK - BLK

Case Style:

S = Studded
N = Non-Studded

1B = Covers “LED Load Output Range” W

3B = Covers “LED Load Output Range” N (CCR dimming only)

Note: Only the model numbers falling into the structure listed above can be configured with QwikFig™. Standard model numbers configured at Lutron will not be capable of being reconfigured at another facility.

¹ QwikFig™ bulk drivers are only available as UL® recognized.

Job Name:	Model Numbers:
Job Number:	

“A” Output Range, Voltage Driver Models

Driver Type	Output Dimming Method	Output Voltage	Output Current	Output Power	Standards Recognition	UL® Listed Option (KL case)
Constant-Voltage Driver (Class 2)	Pulse Width Modulation (PWM)	10.0–12.0 V PWM	0.42–3.3 A	5–40 W		Yes

Voltage Driver Operation Range:

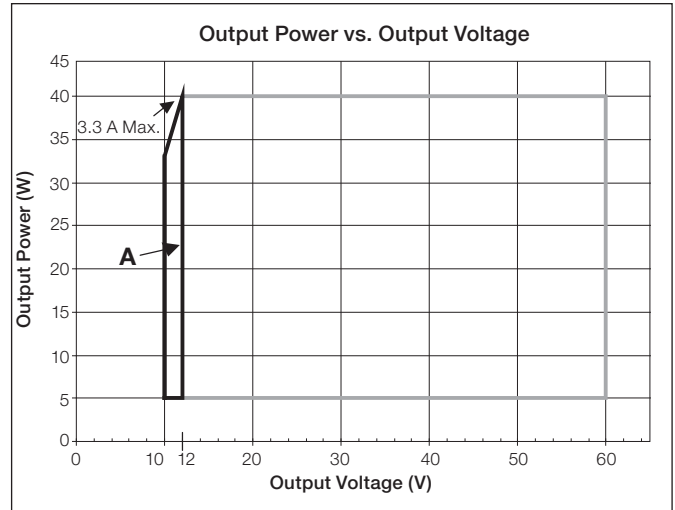
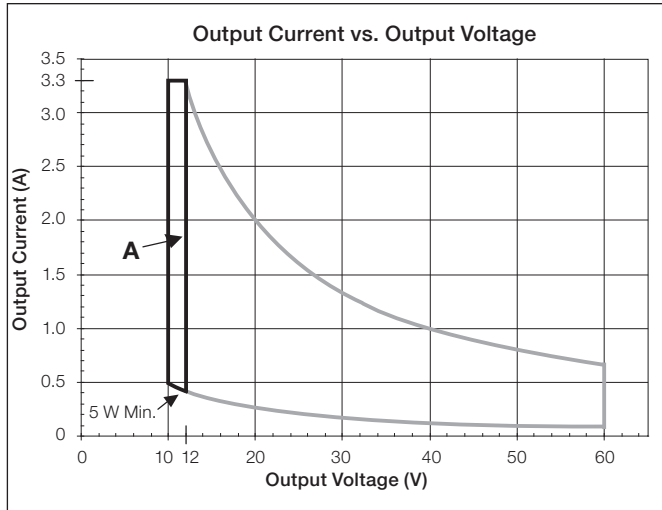

Typical Performance Specifications:

Parameter	120 V~	240 V~	277 V~	Test Conditions
Input Current	390 mA	210 mA	170 mA	t _a = 25 °C, 12.0 V 40 W load, Maximum Light Output, K-case
Power Factor	0.99	0.97	0.95	
THD	14%	17%	16%	
Driver Efficiency	81%	83%	83%	

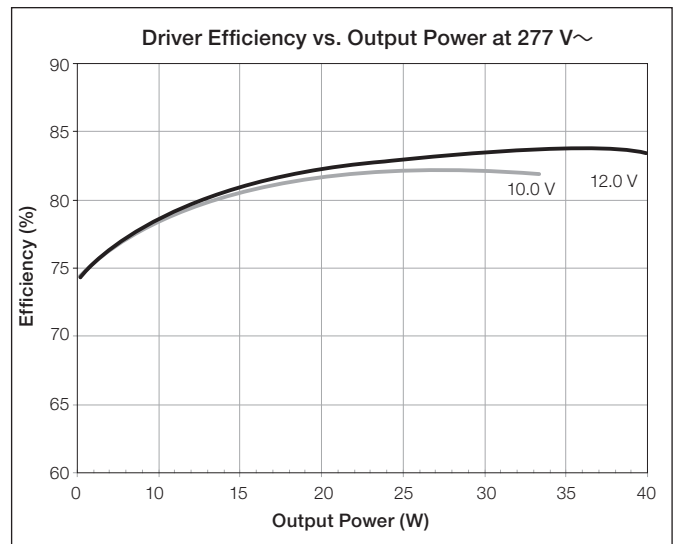
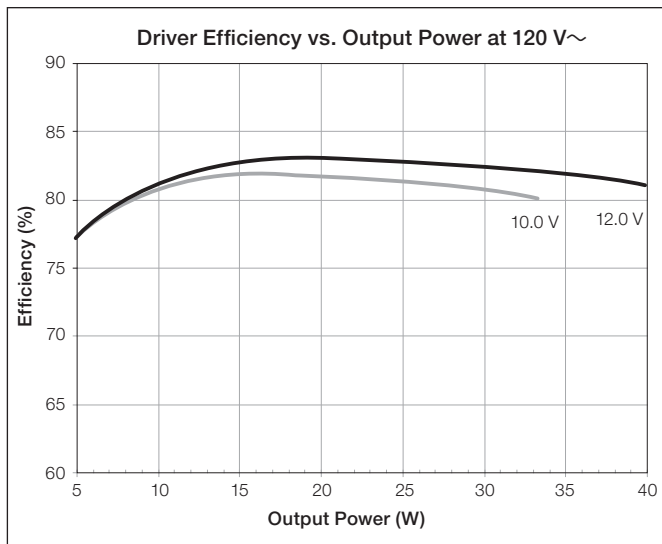

Job Name:	Model Numbers:
Job Number:	

“B” Output Range, Voltage Driver Models

Driver Type	Output Dimming Method	Output Voltage	Output Current	Output Power	Standards Recognition	UL® Listed Option (KL case)
Constant-Voltage Driver (Class 2)	Pulse Width Modulation (PWM)	12.5–20.0 V PWM	0.25–3.2 A	5–40 W		Yes

Voltage Driver Operation Range:

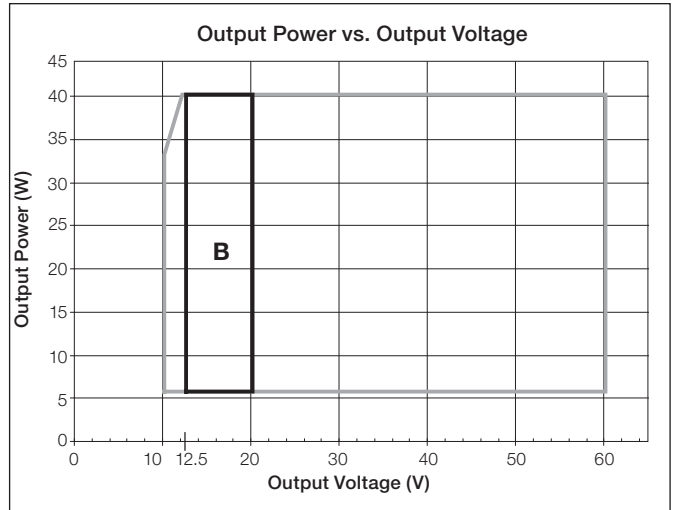
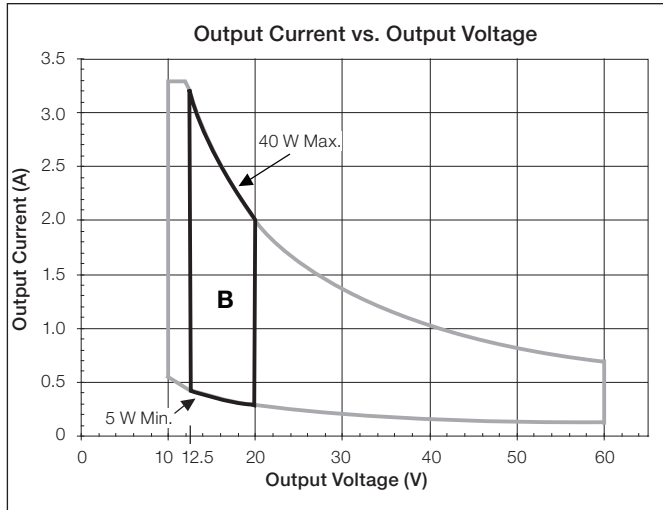

Typical Performance Specifications:

Parameter	120 V~	240 V~	277 V~	Test Conditions
Input Current	390 mA	200 mA	170 mA	t _a = 25 °C, 20.0 V 40 W load, Maximum Light Output, K-case
Power Factor	0.99	0.98	0.97	
THD	10%	8%	9%	
Driver Efficiency	85%	86%	87%	

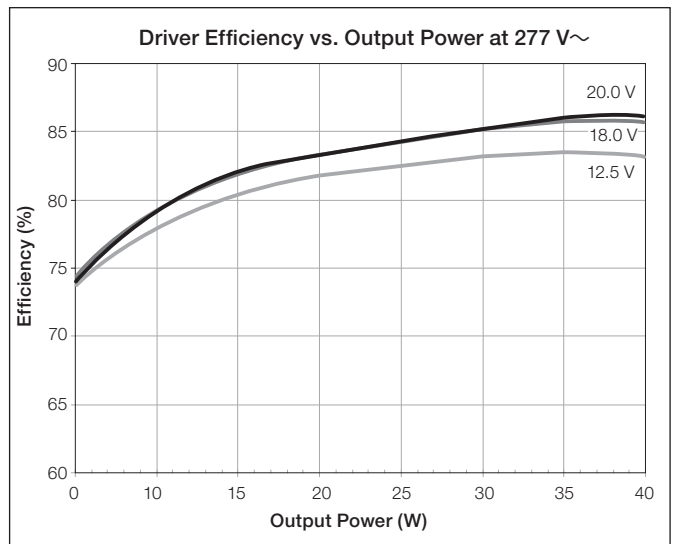
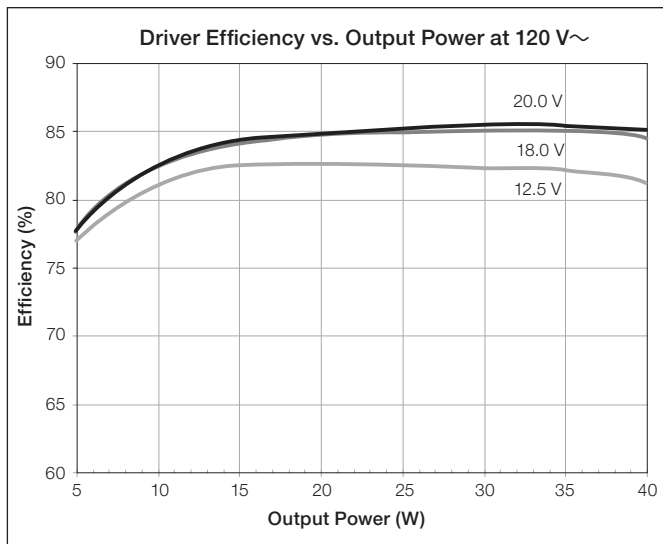

Job Name:	Model Numbers:
Job Number:	

“C” Output Range, Voltage Driver Models

Driver Type	Output Dimming Method	Output Voltage	Output Current	Output Power	Standards Recognition	UL® Listed Option (KL case)
Constant-Voltage Driver (Class 2)	Pulse Width Modulation (PWM)	20.5–24.0 V PWM	0.21–1.95 A	5–40 W		Yes

Voltage Driver Operation Range:

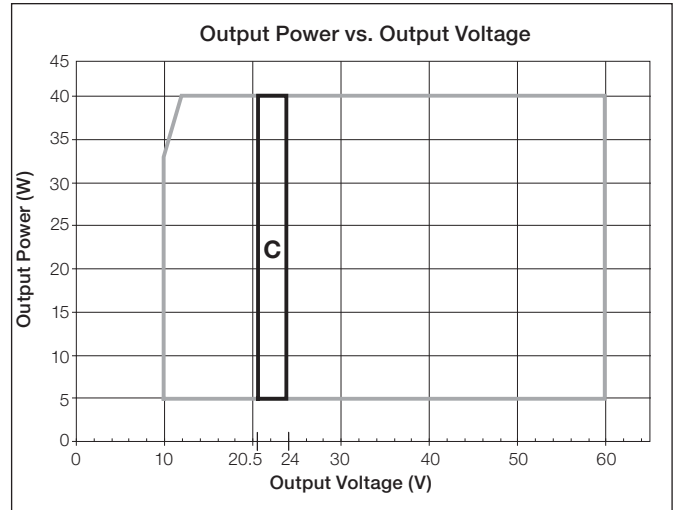
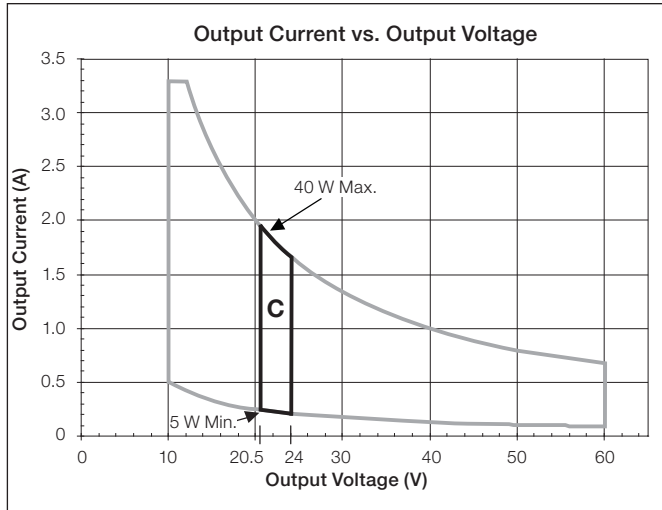

Typical Performance Specifications:

Parameter	120 V~	240 V~	277 V~	Test Conditions
Input Current	370 mA	190 mA	170 mA	t _a = 25 °C, 24.0 V 40 W load, Maximum Light Output, K-case
Power Factor	0.99	0.97	0.96	
THD	10%	10%	12%	
Driver Efficiency	86%	87%	88%	

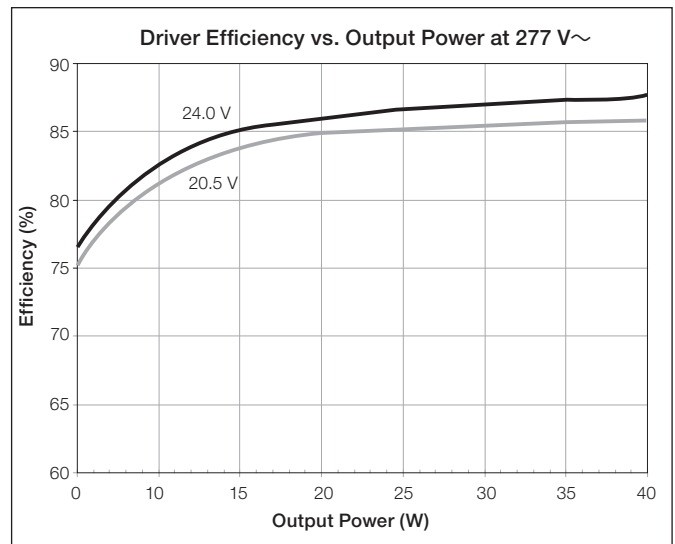
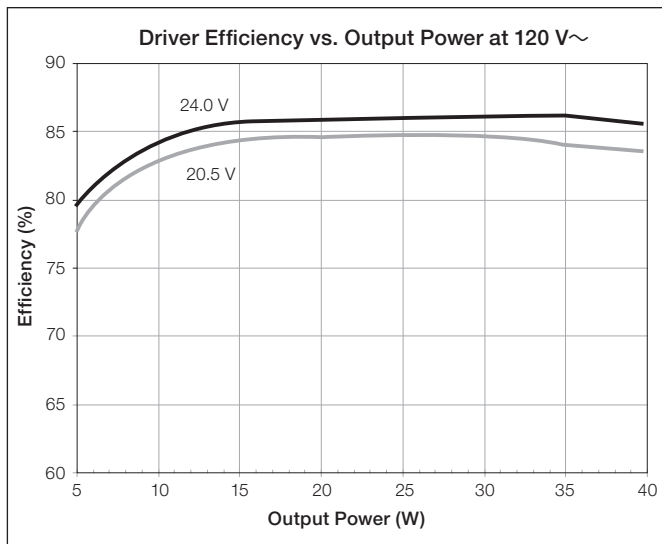

Job Name:	Model Numbers:
Job Number:	

“D” Output Range, Voltage Driver Models

Driver Type	Output Dimming Method	Output Voltage	Output Current	Output Power	Standards Recognition	UL® Listed Option (KL case)
Constant-Voltage Driver (Class 2)	Pulse Width Modulation (PWM)	24.5–38.0 V PWM	0.13–1.63 A	5–40 W		Yes

Voltage Driver Operation Range:

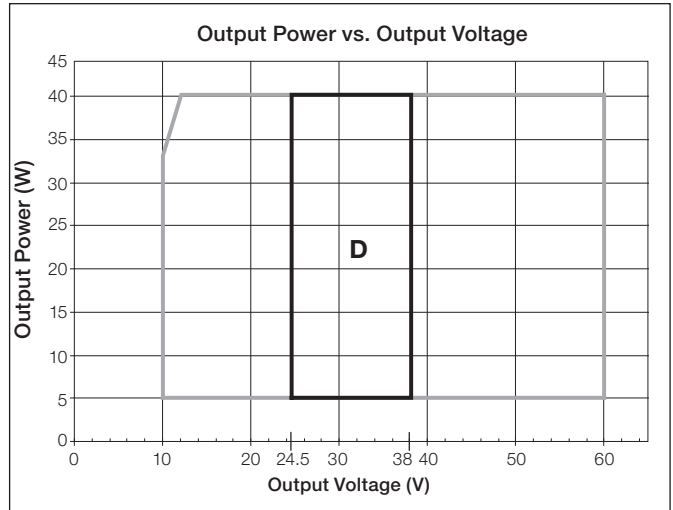
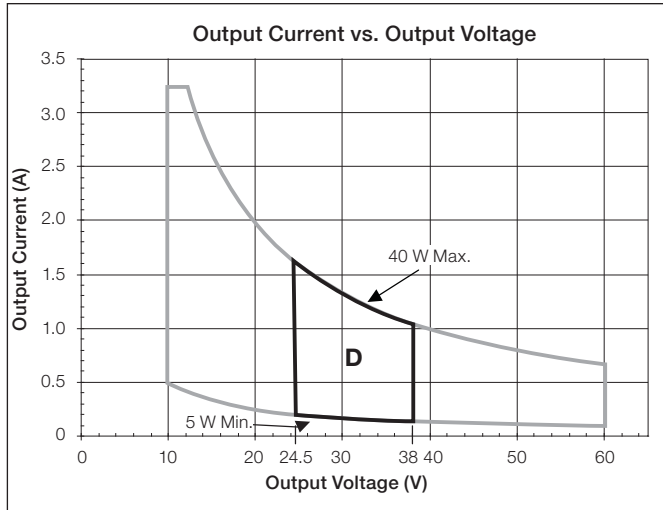

Typical Performance Specifications:

Parameter	120 V~	240 V~	277 V~	Test Conditions
Input Current	370 mA	190 mA	170 mA	t _a = 25 °C, 38.0 V 40 W load, Maximum Light Output, K-case
Power Factor	0.99	0.98	0.98	
THD	6%	9%	11%	
Driver Efficiency	87%	88%	88%	

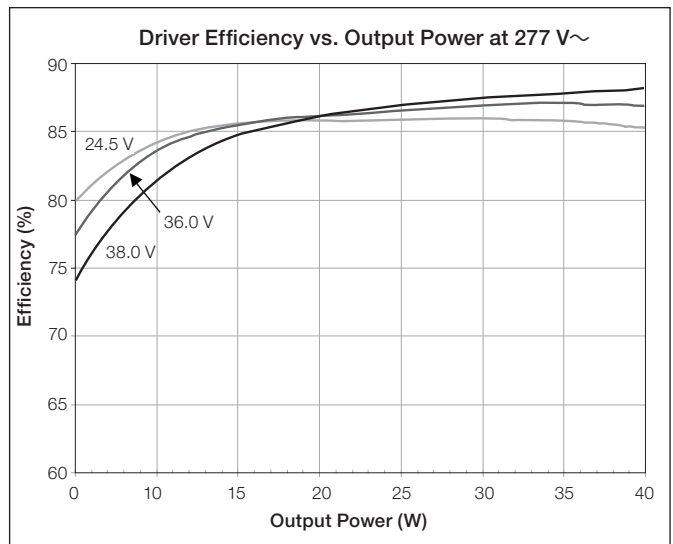
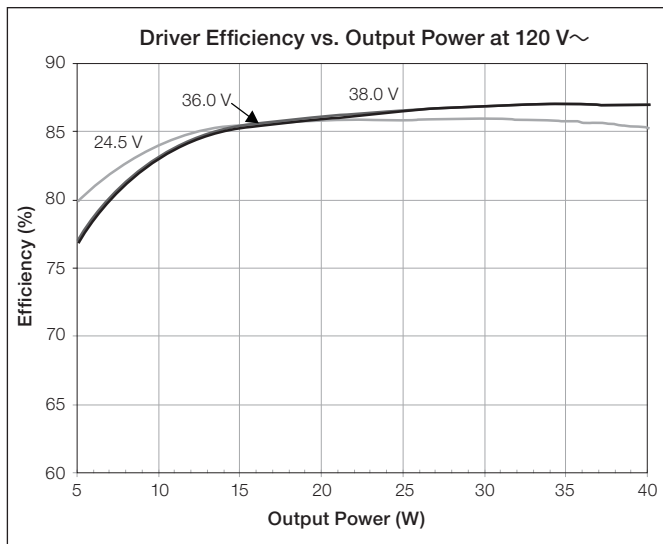

Job Name:	Model Numbers:
Job Number:	

“E” Output Range, Current Driver Models

Driver Type	Output Dimming Method	Output Voltage	Output Current	Output Power	Standards Recognition	UL® Listed Option (KL case)
Constant-Current Driver (Class 2)	Constant-Current Reduction (CCR)	30–54 V \equiv	0.20–0.50 A	6–27 W	 Type TL 83 °/66 °C - K-case Type TL 90 °/72 °C - M-case	Yes

When using QwikFig™ technology, these models can be built from the following bulk units:

K-case - L3DA4U1UKx-3ABLK*; M-case - L3DA4U1UMN-3ABLK

* x = studded (S) or non-studded (N)

Current Driver Operation Range:

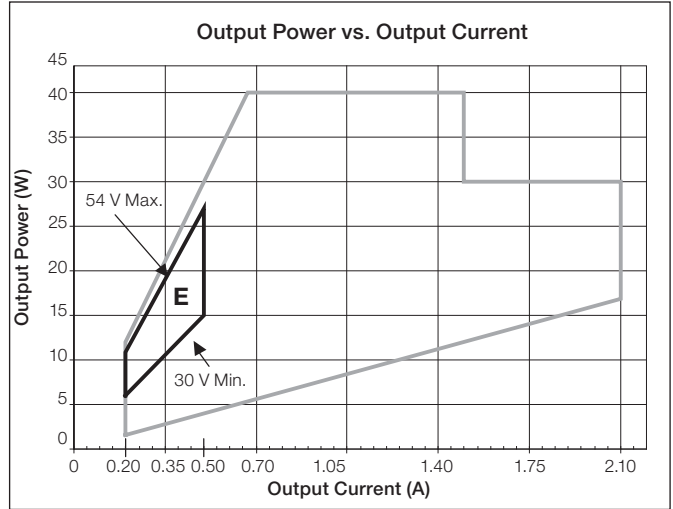
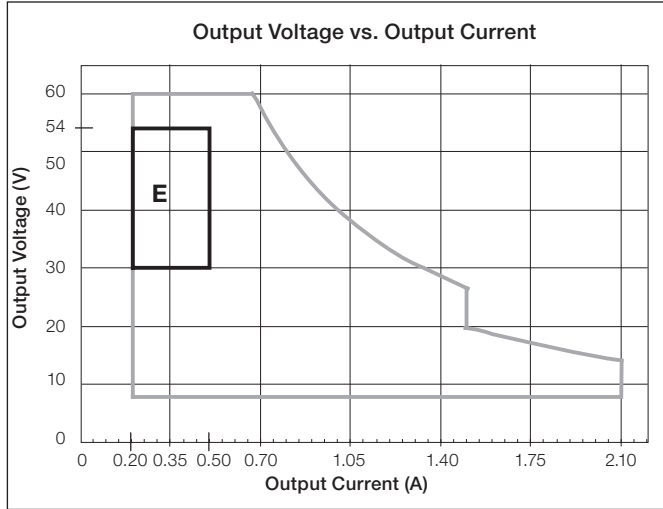

Typical Performance Specifications:

Parameter	120 V \sim	240 V \sim	277 V \sim	Test Conditions
Input Current	260 mA	140 mA	110 mA	t _a = 25 °C, 0.50 A 27 W load, Maximum Light Output, K-case
Power Factor	0.99	0.98	0.96	
THD	10%	10%	12%	
Driver Efficiency	85%	85%	85%	

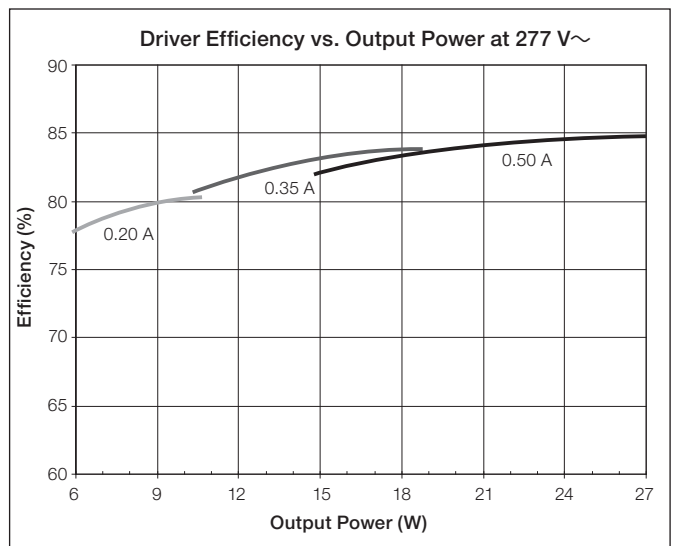
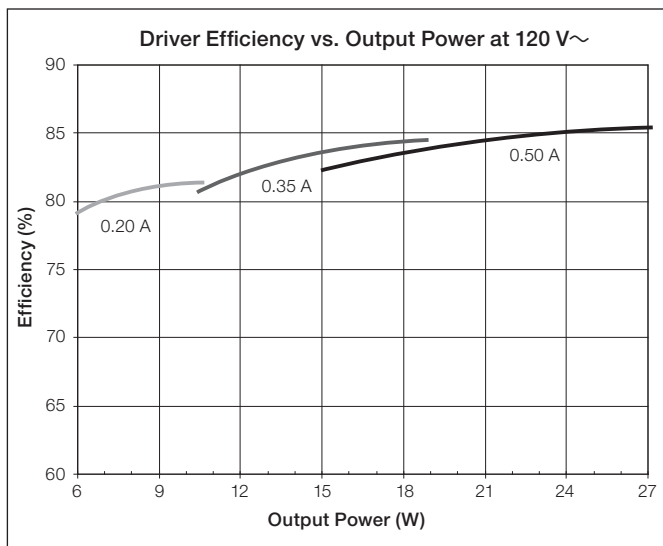

Job Name:	Model Numbers:
Job Number:	

“F” Output Range, Current Driver Models

Driver Type	Output Dimming Method	Output Voltage	Output Current	Output Power	Standards Recognition	UL® Listed Option (KL case)
Constant-Current Driver (Class 2)	Constant-Current Reduction (CCR)	30–54 V _{DC}	0.51–1.00 A	15–40 W	 Type TL 83 °/66 °C - K-case Type TL 90 °/72 °C - M-case	Yes

When using QwikFig™ technology, these models can be built from the following bulk units:

K-case - L3DA4U1UKx-3ABLK*; M-case - L3DA4U1UMN-3ABLK

* x = studded (S) or non-studded (N)

Current Driver Operation Range:

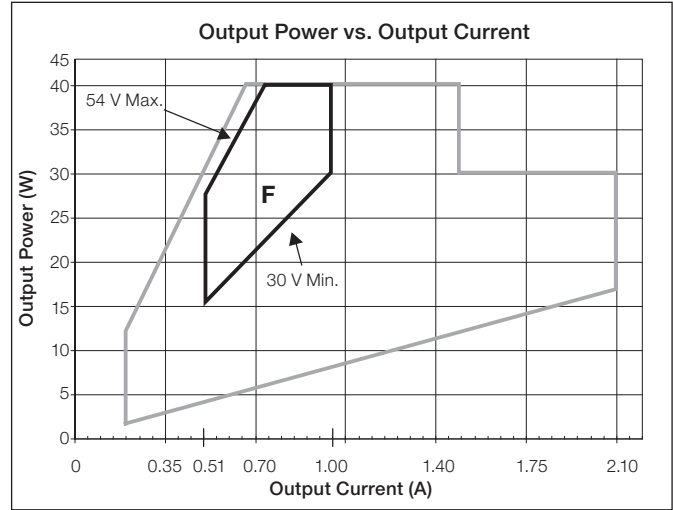
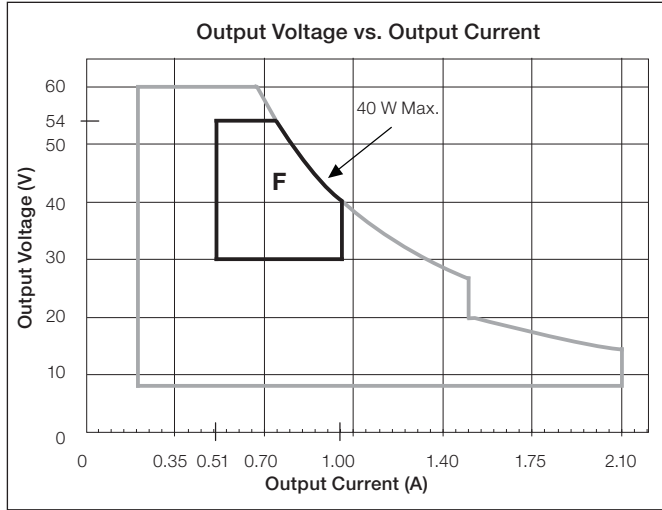

Typical Performance Specifications:

Parameter	120 V _~	240 V _~	277 V _~	Test Conditions
Input Current	380 mA	200 mA	160 mA	t _a = 25 °C, 1.00 A 40 W load, Maximum Light Output, K-case
Power Factor	0.99	0.99	0.98	
THD	8%	9%	11%	
Driver Efficiency	84%	86%	86%	

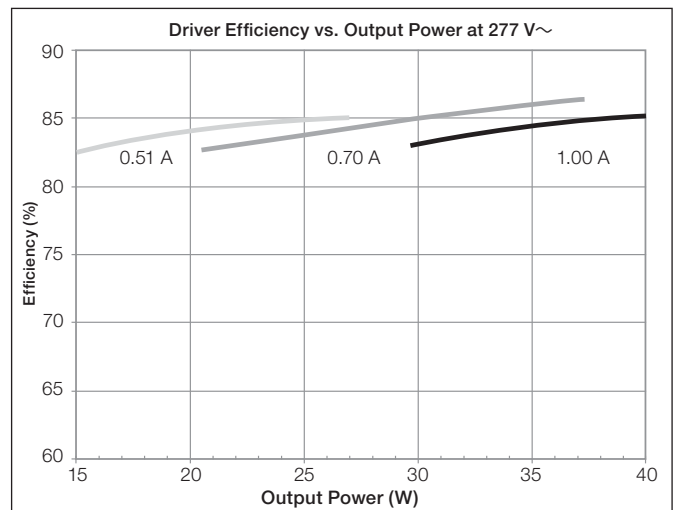
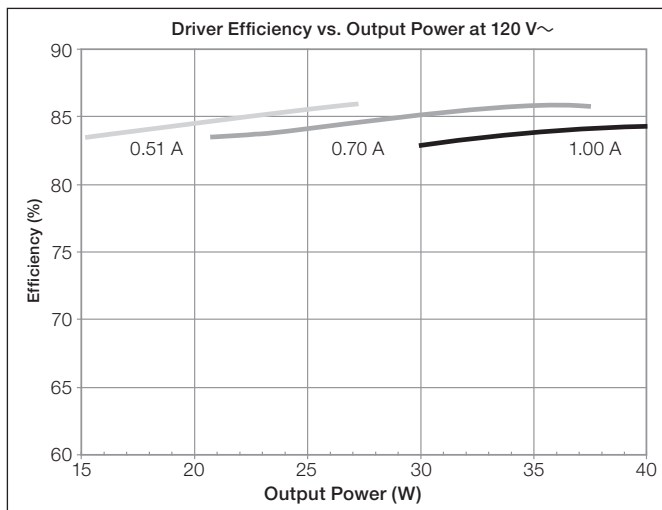

Job Name:	Model Numbers:
Job Number:	

“G” Output Range, Current Driver Models

Driver Type	Output Dimming Method	Output Voltage	Output Current	Output Power	Standards Recognition	UL® Listed Option (KL case)
Constant-Current Driver (Class 2)	Pulse Width Modulation (PWM)	8–20 V PWM	0.20–0.70 A	2–14 W	 Type TL 87 °/55 °C - K-case Type TL 89 °/68 °C - M-case	Yes
	Constant-Current Reduction (CCR)	8–20 V~				

When using QwikFig™ technology, these models can be built from the following bulk units:

K-case - L3DA4U1UKx-2GBLK*; M-case - L3DA4U1UMN-2CBLK

* x = studded (S) or non-studded (N)

Current Driver Operation Range:

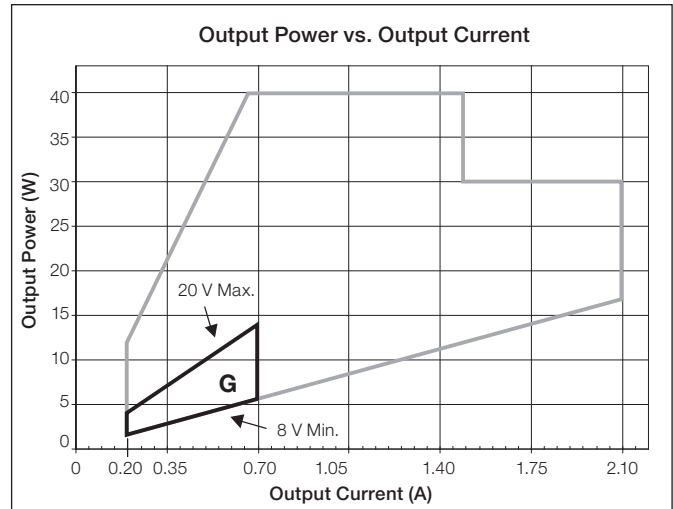
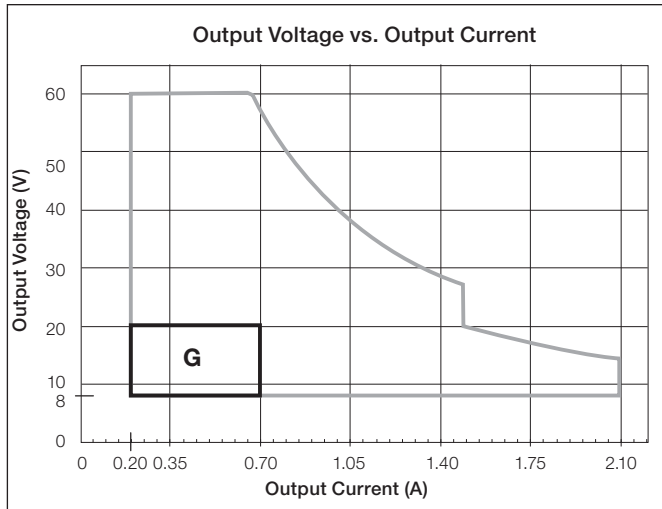

Typical Performance Specifications:

Parameter	120 V~	240 V~	277 V~	Test Conditions
Input Current	140 mA	90 mA	70 mA	t _a = 25 °C, 0.70 A 14 W load, Maximum Light Output, K-case
Power Factor	0.99	0.89	0.85	
THD	11%	16%	20%	
Driver Efficiency	80%	80%	79%	

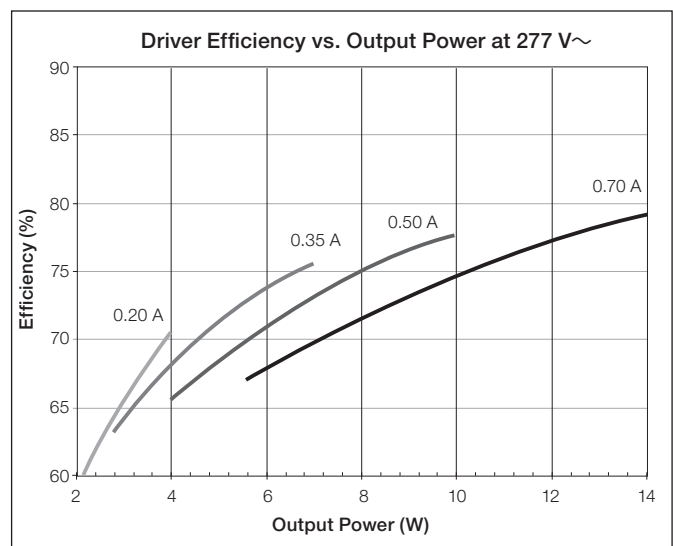
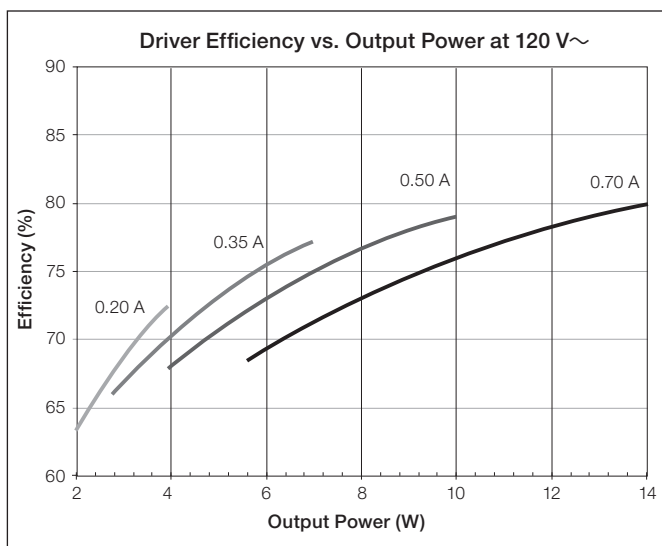

Job Name:	Model Numbers:
Job Number:	

“H” Output Range, Current Driver Models

Driver Type	Output Dimming Method	Output Voltage	Output Current	Output Power	Standards Recognition	UL® Listed Option (KL case)
Constant-Current Driver (Class 2)	Pulse Width Modulation (PWM)	15–38 V PWM	0.20–0.70 A	3–26.6 W	 Type TL 89 °/61 °C - K-case Type TL 89 °/74 °C - M-case	Yes
	Constant-Current Reduction (CCR)	15–38 V=				

When using QwikFig™ technology, these models can be built from the following bulk units:

K-case - L3DA4U1UKx-2HBLK*; M-case - L3DA4U1UMN-2BBLK

* x = studded (S) or non-studded (N)

Current Driver Operation Range:

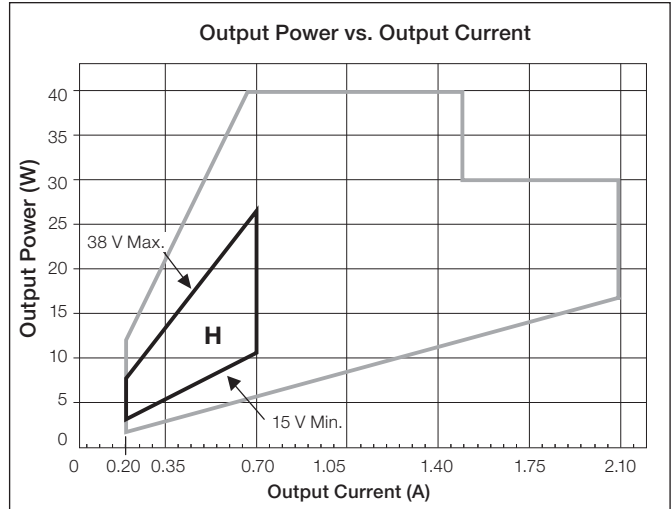
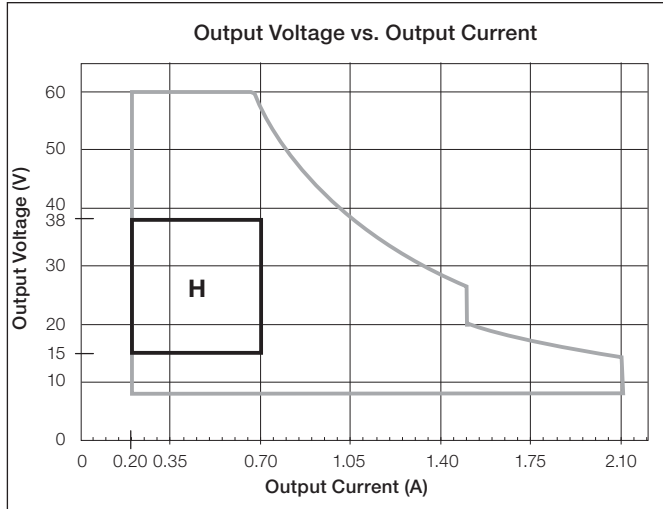

Typical Performance Specifications:

Parameter	120 V~	240 V~	277 V~	Test Conditions
Input Current	270 mA	140 mA	120 mA	t _a = 25 °C, 0.70 A 26 W load, Maximum Light Output, K-case
Power Factor	0.99	0.96	0.94	
THD	7%	10%	12%	
Driver Efficiency	84%	85%	85%	

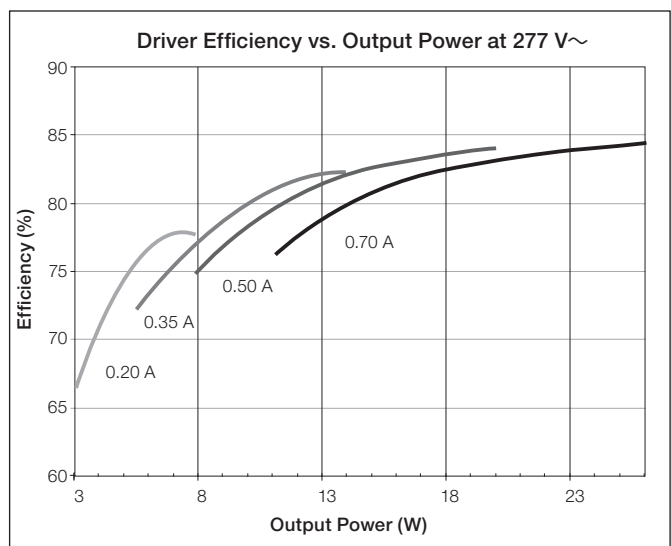
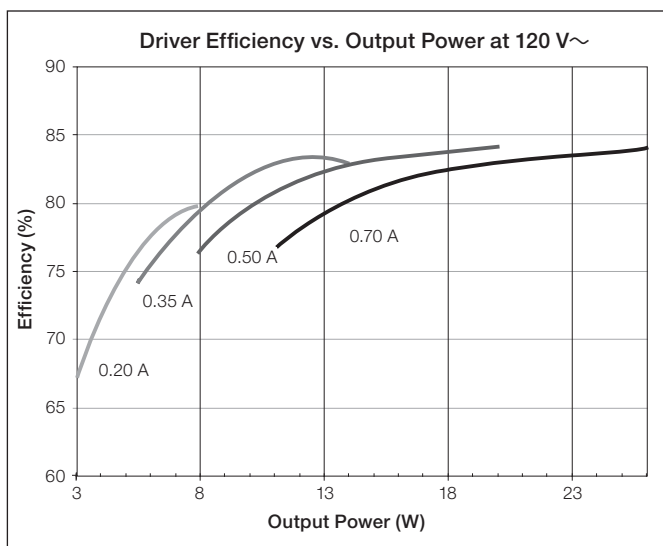

Job Name:	Model Numbers:
Job Number:	

"I" Output Range, Current Driver Models

Driver Type	Output Dimming Method	Output Voltage	Output Current	Output Power	Standards Recognition	UL® Listed Option (KL case)
Constant-Current Driver (Class 2)	Pulse Width Modulation (PWM)	8–20 V PWM	0.71–1.05 A	6–21 W	 Type TL 86 °/63 °C - K-case Type TL 89 °/68 °C - M-case	Yes
	Constant-Current Reduction (CCR)	8–20 V $\overline{=}$				

When using QwikFig™ technology, these models can be built from the following bulk units:

K-case - L3DA4U1UKx-2RBLK*; M-case - L3DA4U1UMN-2CBLK

* x = studded (S) or non-studded (N)

Current Driver Operation Range:

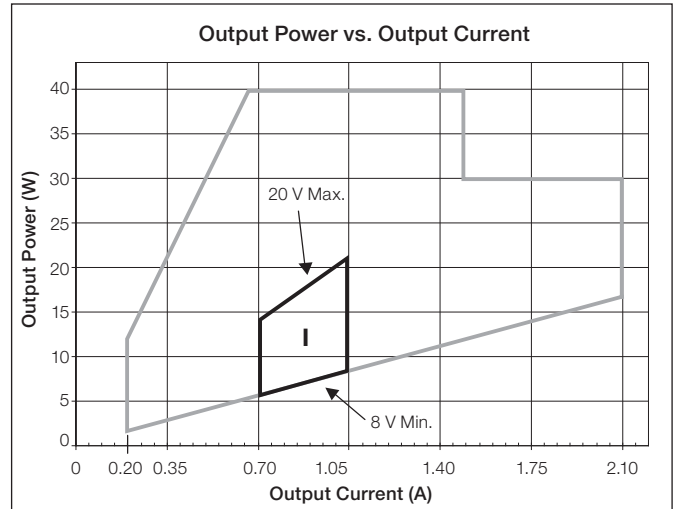
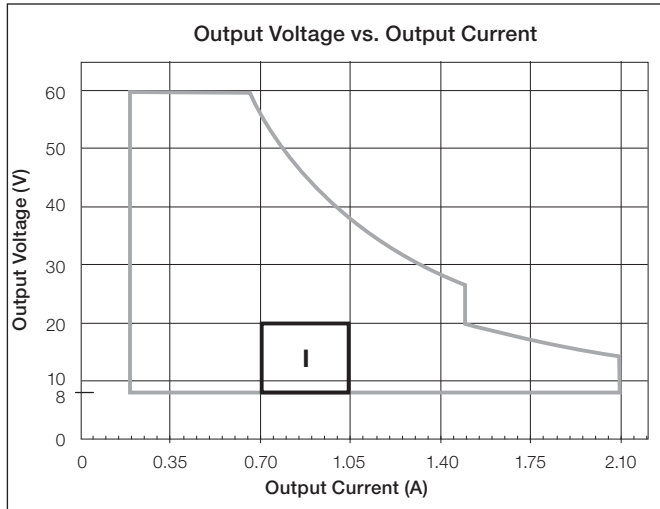

Typical Performance Specifications:

Parameter	120 V \sim	240 V \sim	277 V \sim	Test Conditions
Input Current	210 mA	120 mA	100 mA	t _a = 25 °C, 1.05 A 21 W load, Maximum Light Output, K-case
Power Factor	0.98	0.94	0.92	
THD	15%	13%	14%	
Driver Efficiency	82%	81%	81%	

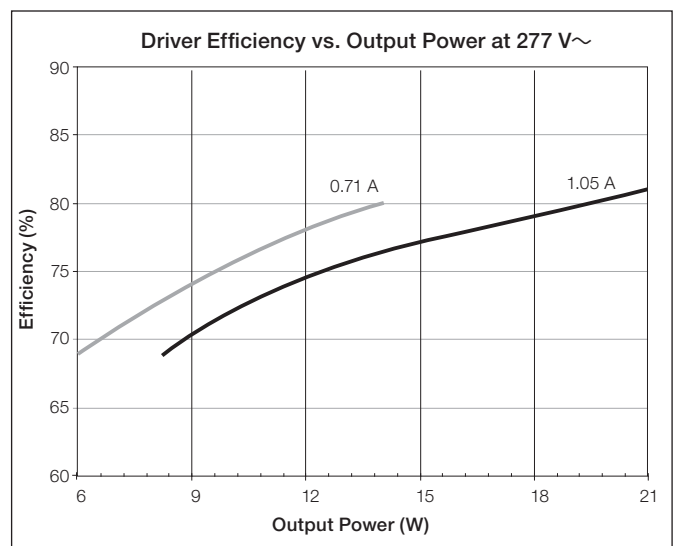
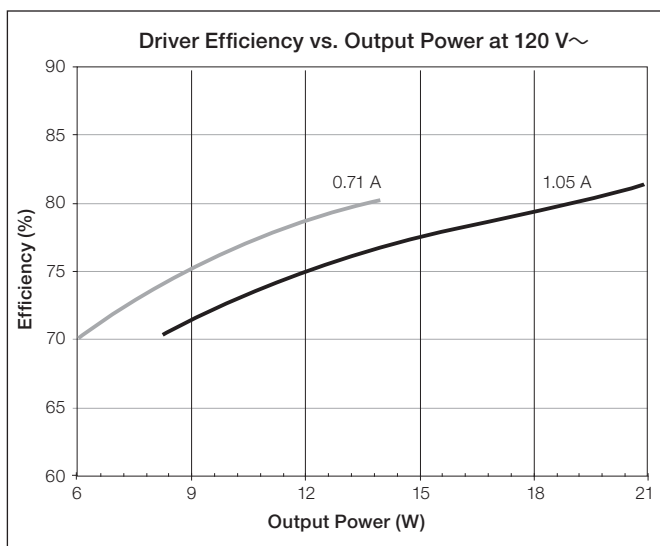

Job Name:	Model Numbers:
Job Number:	

“J” Output Range, Current Driver Models

Driver Type	Output Dimming Method	Output Voltage	Output Current	Output Power	Standards Recognition	UL® Listed Option (KL case)
Constant-Current Driver (Class 2)	Pulse Width Modulation (PWM)	15–38 V PWM	0.71–1.05 A	11–40 W	 Type TL 86 °/69 °C - K-case Type TL 89 °/74 °C - M-case	Yes
	Constant-Current Reduction (CCR)	15–38 V=				

When using QwikFig™ technology, these models can be built from the following bulk units:

K-case - L3DA4U1UKx-2SBLK*; M-case - L3DA4U1UMN-2BBLK

* x = studded (S) or non-studded (N)

Current Driver Operation Range:

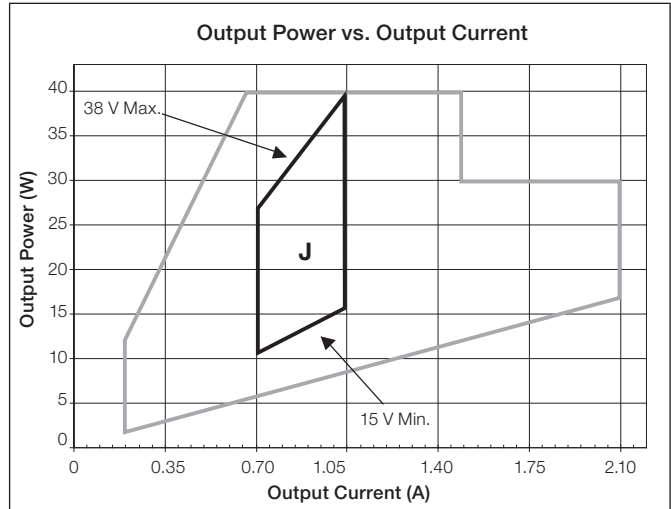
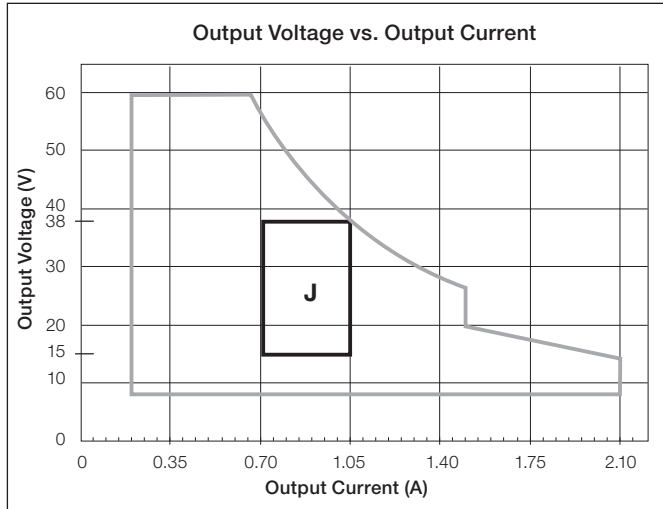

Typical Performance Specifications:

Parameter	120 V~	240 V~	277 V~	Test Conditions
Input Current	390 mA	200 mA	170 mA	t _a = 25 °C, 1.05 A 40 W load, Maximum Light Output, K-case
Power Factor	0.99	0.98	0.97	
THD	6%	9%	10%	
Driver Efficiency	85%	86%	86%	

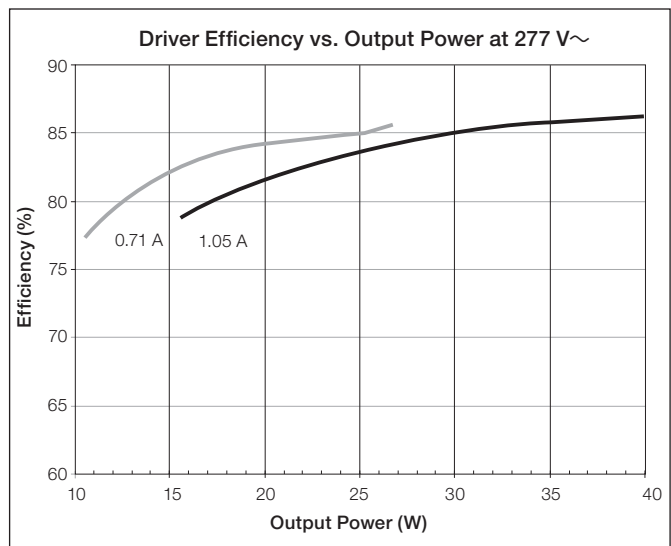
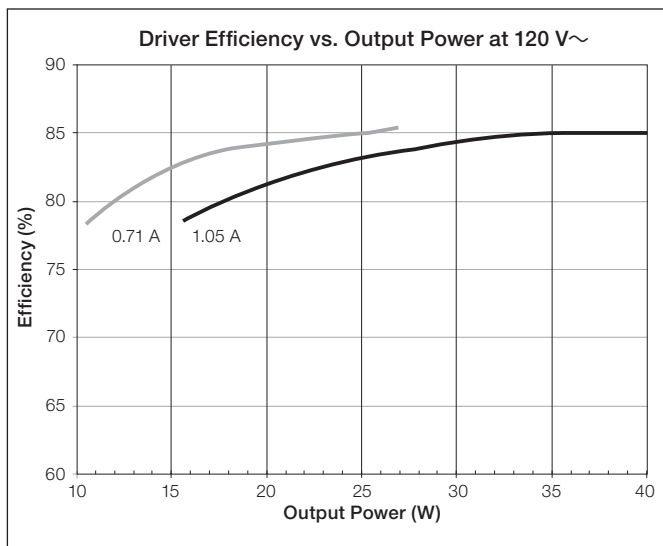

Job Name:	Model Numbers:
Job Number:	

“K” Output Range, Current Driver Models

Driver Type	Output Dimming Method	Output Voltage	Output Current	Output Power	Standards Recognition	UL® Listed Option (KL case)
Constant-Current Driver (Class 2)	Pulse Width Modulation (PWM)	8–20 V PWM	1.06–1.50 A	9–30 W	 Type TL 86 °/63 °C - K-case Type TL 89 °/68 °C - M-case	Yes
	Constant-Current Reduction (CCR)	8–20 V \approx				

When using QwikFig™ technology, these models can be built from the following bulk units:

K-case - L3DA4U1UKx-2RBLK*; **M-case** - L3DA4U1UMN-2CBLK

* x = studded (S) or non-studded (N)

Current Driver Operation Range:

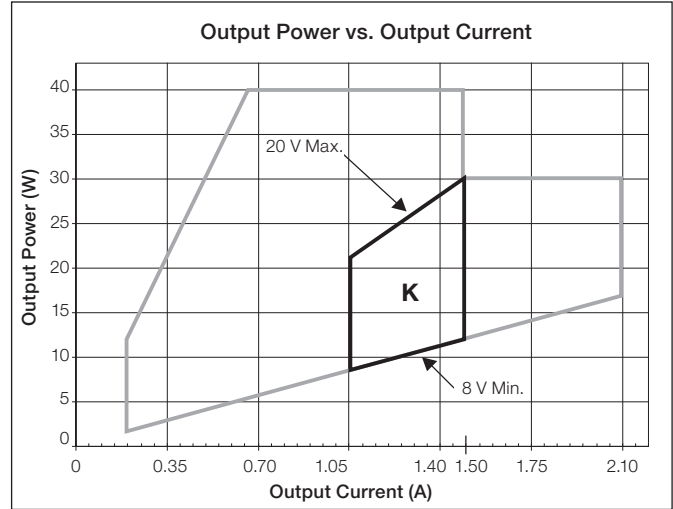
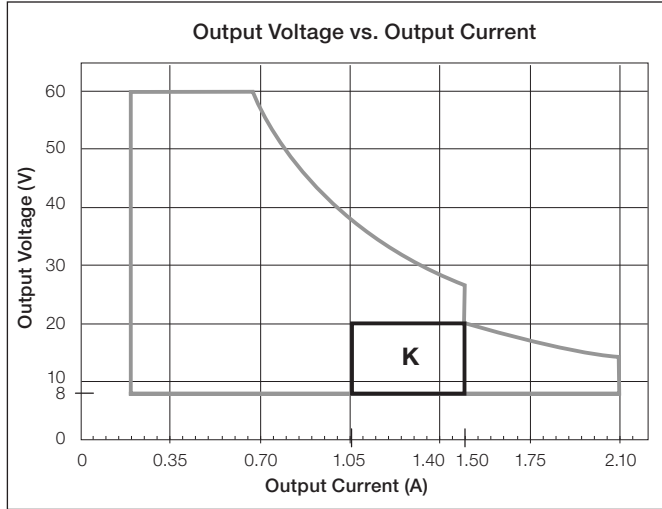

Typical Performance Specifications:

Parameter	120 V \sim	240 V \sim	277 V \sim	Test Conditions
Input Current	310 mA	160 mA	130 mA	t _a = 25 °C, 1.50 A 30 W load, Maximum Light Output, K-case
Power Factor	0.99	0.96	0.94	
THD	15%	17%	15%	
Driver Efficiency	81%	83%	82%	

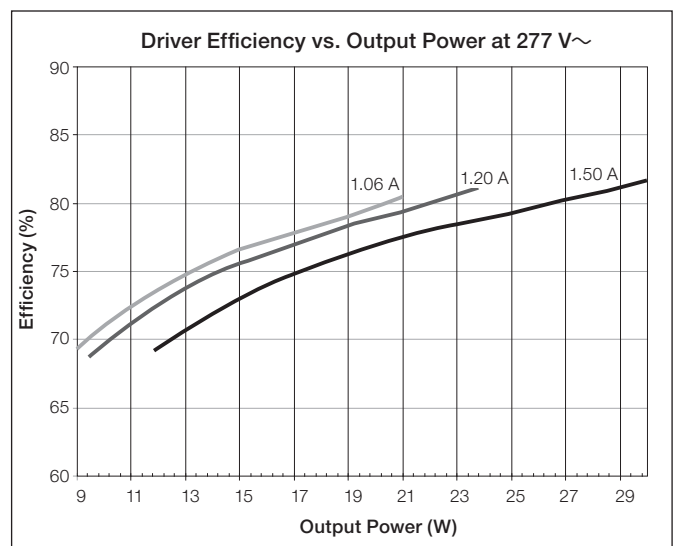
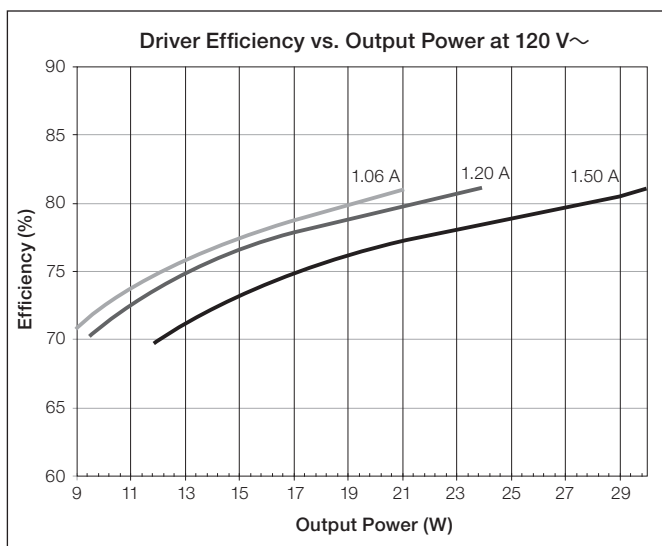

Job Name:	Model Numbers:
Job Number:	

“L” Output Range, Current Driver Models

Driver Type	Output Dimming Method	Output Voltage	Output Current	Output Power	Standards Recognition	UL® Listed Option (KL case)
Constant-Current Driver (Class 2)	Pulse Width Modulation (PWM)	15–38 V PWM	1.06–1.50 A	16–40 W	 Type TL 86 °/69 °C - K-case Type TL 89 °/74 °C - M-case	Yes
	Constant-Current Reduction (CCR)	15–38 V=				

When using QwikFig™ technology, these models can be built from the following bulk units:

K-case - L3DA4U1UKx-2SBLK*; M-case - L3DA4U1UMN-2BBLK

* x = studded (S) or non-studded (N)

Current Driver Operation Range:

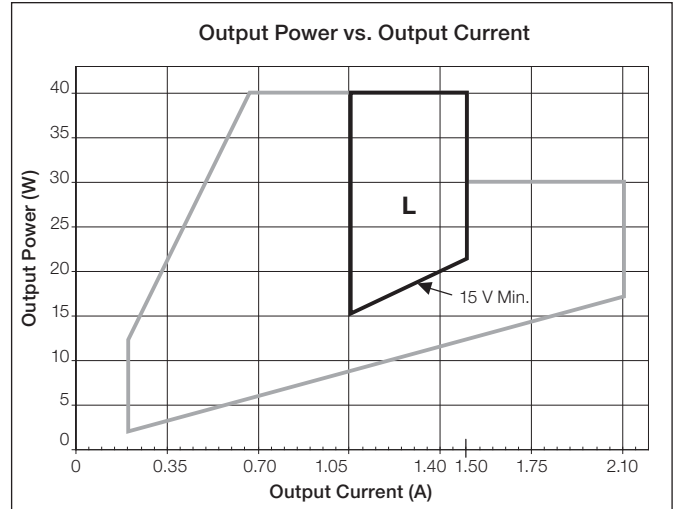
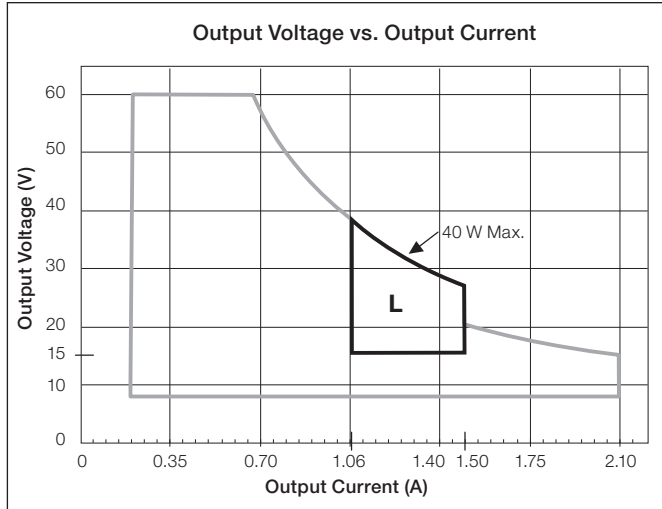

Typical Performance Specifications:

Parameter	120 V~	240 V~	277 V~	Test Conditions
Input Current	390 mA	200 mA	180 mA	t _a = 25 °C, 1.50 A 40 W load, Maximum Light Output, K-case
Power Factor	0.99	0.97	0.96	
THD	9%	13%	12%	
Driver Efficiency	83%	85%	85%	

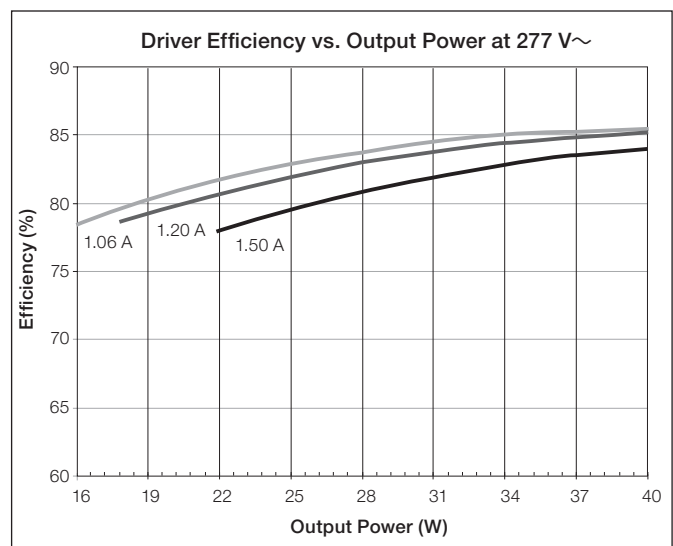
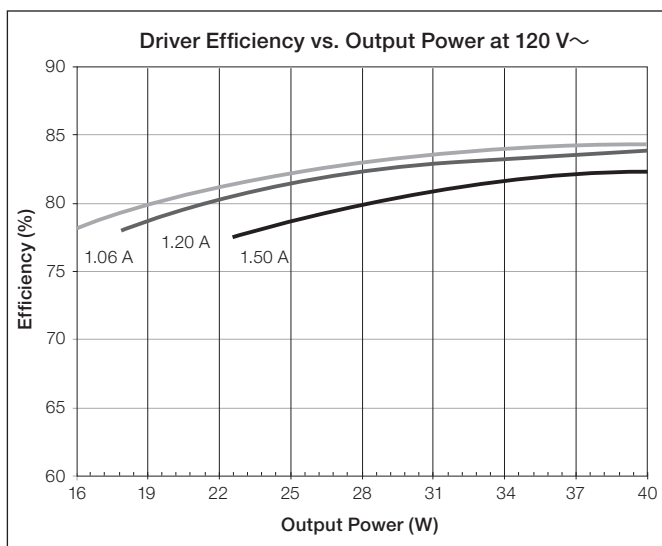

Job Name:	Model Numbers:
Job Number:	

“M” Output Range, Current Driver Models

Driver Type	Output Dimming Method	Output Voltage	Output Current	Output Power	Standards Recognition	UL® Listed Option (KL case)
Constant-Voltage Driver (Isolated, Non-Class 2)	Pulse Width Modulation (PWM)	8–19.9 V PWM	1.51–2.10 A	12–30 W	 Type TL 89 °/67 °C - K-case Type TL 89 °/71 °C - M-case	Yes
	Constant-Current Reduction (CCR)	8–19.9 V==				

When using QwikFig™ technology, these models can be built from the following bulk units:

K-case - L3DA4U1UKx-2ABLK*; M-case - L3DA4U1UMN-2ABLK

* x = studded (S) or non-studded (N)

Current Driver Operation Range:

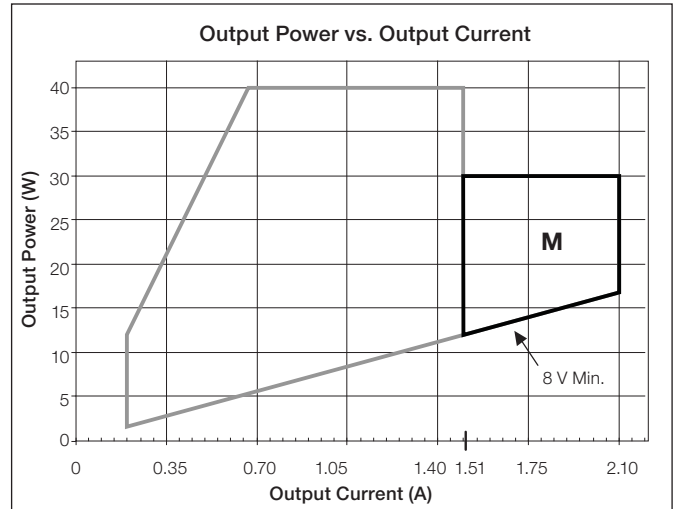
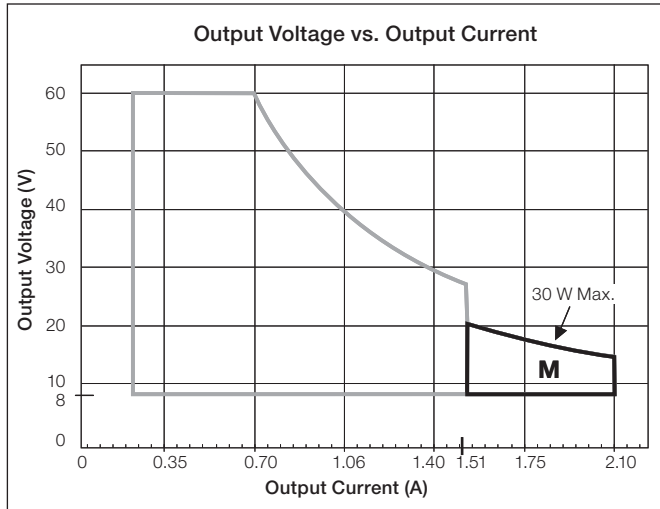

Typical Performance Specifications:

Parameter	120 V~	240 V~	277 V~	Test Conditions
Input Current	310 mA	160 mA	140 mA	t _a = 25 °C, 2.10 A 30 W load, Maximum Light Output, K-case
Power Factor	0.99	0.97	0.95	
THD	12%	12%	12%	
Driver Efficiency	80%	81%	81%	

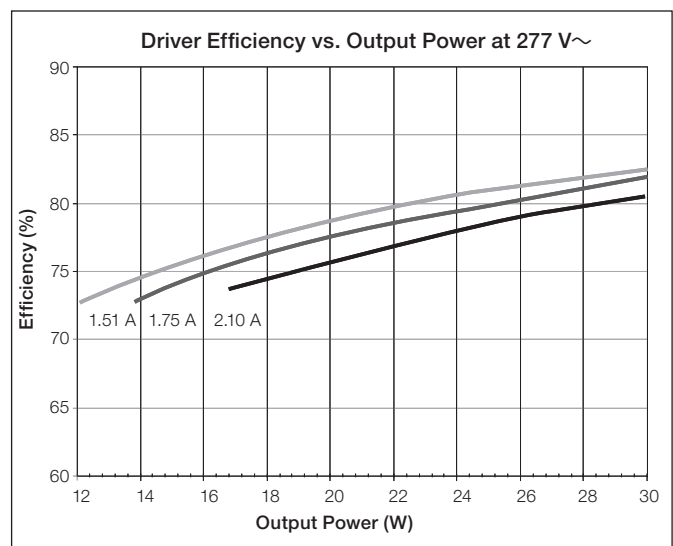
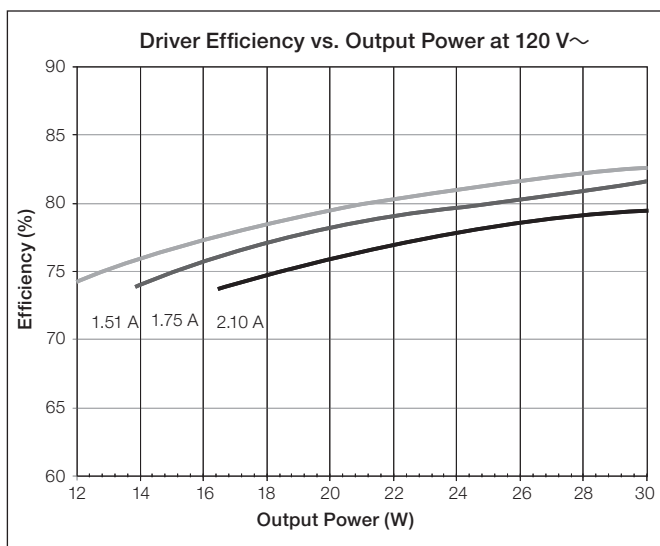

Job Name:	Model Numbers:
Job Number:	

“N” Output Range, Current Driver Models

Driver Type	Output Dimming Method	Output Voltage	Output Current	Output Power	Standards Recognition	UL® Listed Option (KL case)
Constant-Current Driver (Class 2)	Constant-Current Reduction (CCR)	30–54 V ⁼⁼	0.71–1.05 A	25–53 W	 Type TL 87 °/71 °C - K-case	No

When using QwikFig™ technology, these models can be built from the following bulk unit:

K-case - L3DA5U1UKx-3BBLK*

* x = studded (S) or non-studded (N)

Current Driver Operation Range:

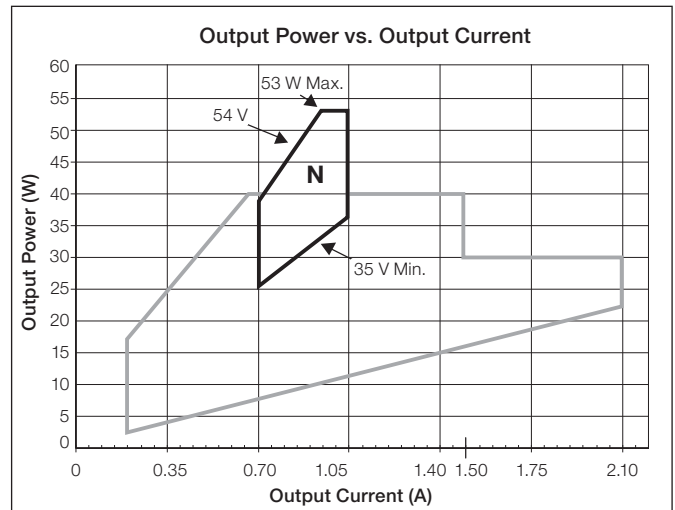
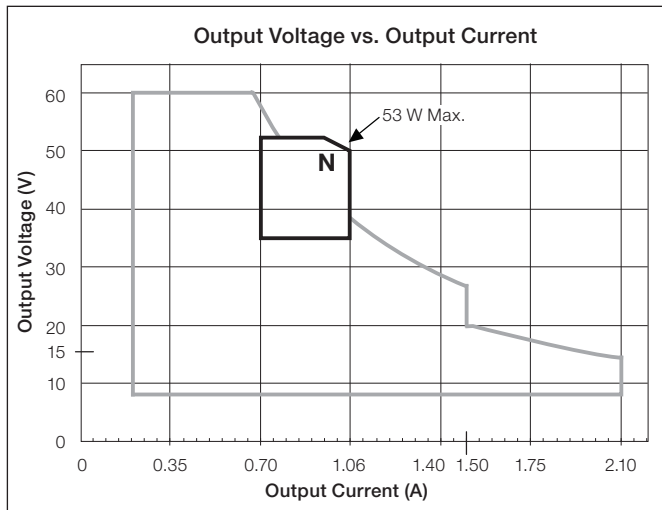

Typical Performance Specifications:

Parameter	120 V [~]	240 V [~]	277 V [~]	Test Conditions
Input Current	510 mA	255 mA	220 mA	t _a = 25 °C, 1.05 A 53 W load, Maximum Light Output, K-case
Power Factor	1.00	0.99	0.99	
THD	12%	10%	10%	
Driver Efficiency	83%	84%	85%	

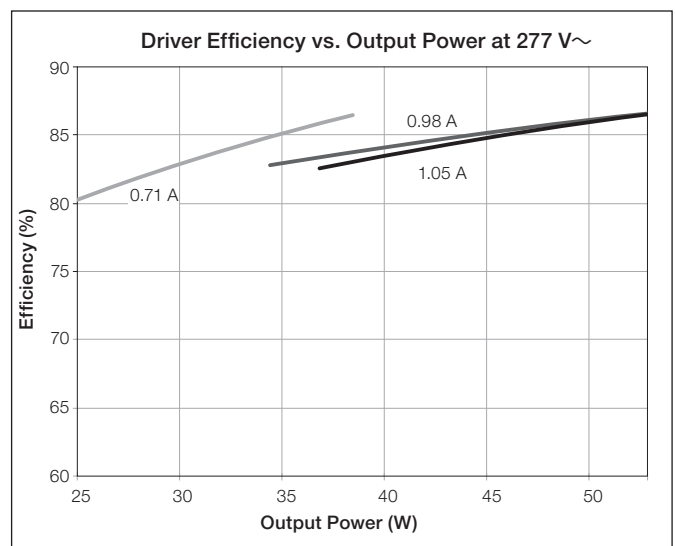
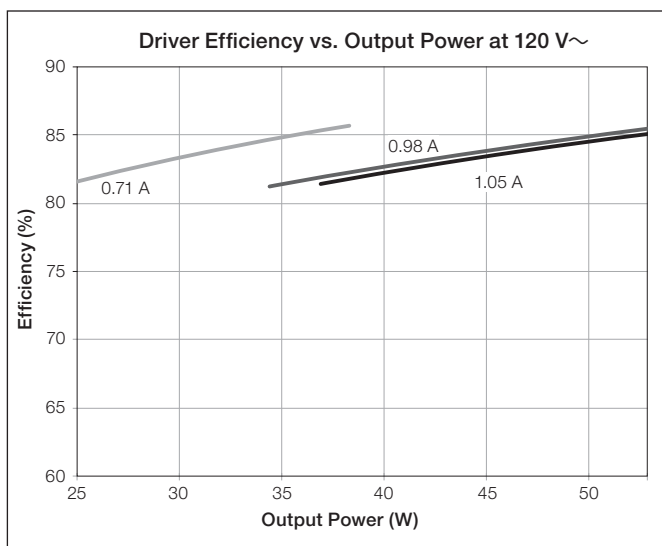

Job Name:	Model Numbers:
Job Number:	

“W” Output Range, Current Driver Models

Driver Type	Output Dimming Method	Output Voltage	Output Current	Output Power	Standards Recognition	UL® Listed Option (KL case)
Constant-Voltage Driver (Isolated, Non-Class 2)	Pulse Width Modulation (PWM)	35–60 V PWM	0.71–1.05 A	25–53 W	 Type TL 85 °/71 °C - K-case	No
	Constant-Current Reduction (CCR)	35–60 V=				

When using QwikFig™ technology, these models can be built from the following bulk unit:

K-case - L3DA5U1UKx-1BBLK*

* x = studded (S) or non-studded (N)

Current Driver Operation Range:

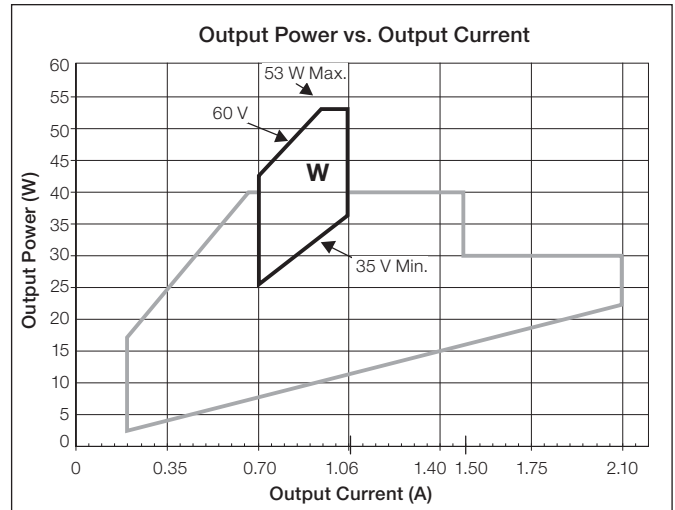
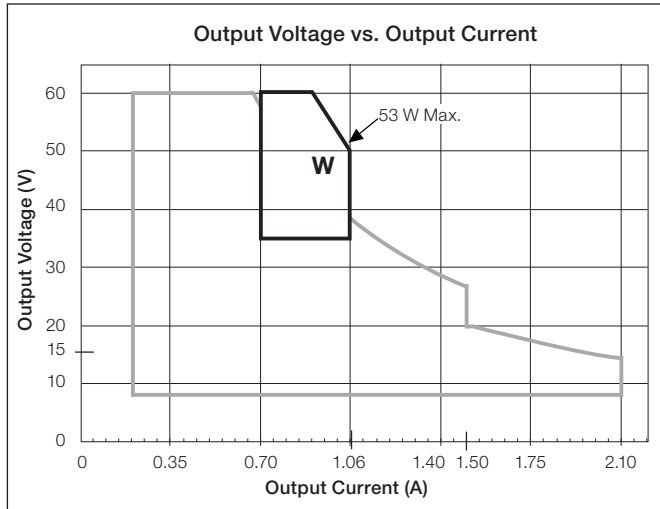

Typical Performance Specifications:

Parameter	120 V~	240 V~	277 V~	Test Conditions
Input Current	510 mA	255 mA	220 mA	t _a = 25 °C, 1.05 A 53 W load, Maximum Light Output, K-case
Power Factor	1.00	0.99	0.99	
THD	12%	10%	10%	
Driver Efficiency	83%	84%	85%	

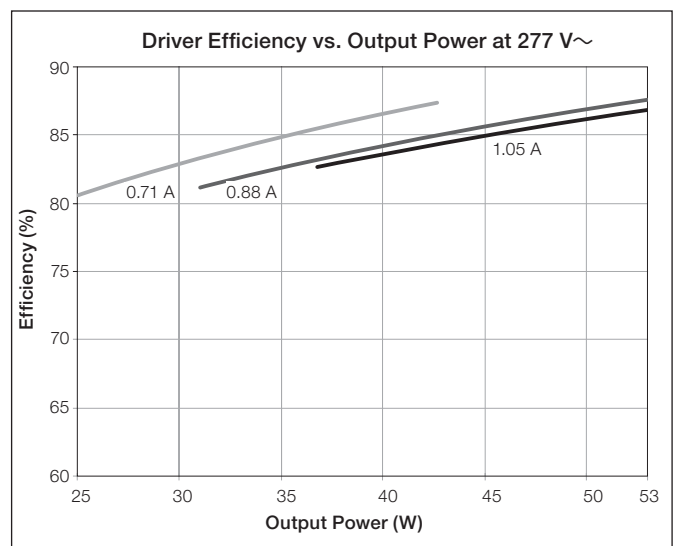
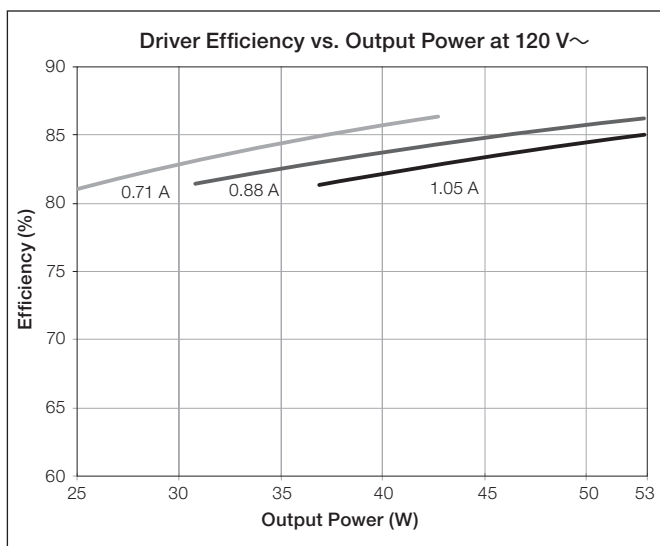

Job Name:	Model Numbers:
Job Number:	

“X” Output Range, Voltage Driver Models

Driver Type	Output Dimming Method	Output Voltage	Output Current	Output Power	Standards Recognition	UL® Listed Option (KL case)
Constant-Voltage Driver (Isolated, Non-Class 2)	Pulse Width Modulation (PWM)	38.5 – 60.0 V PWM	0.08–1.04 A	5–40 W		No

Voltage Driver Operation Range:

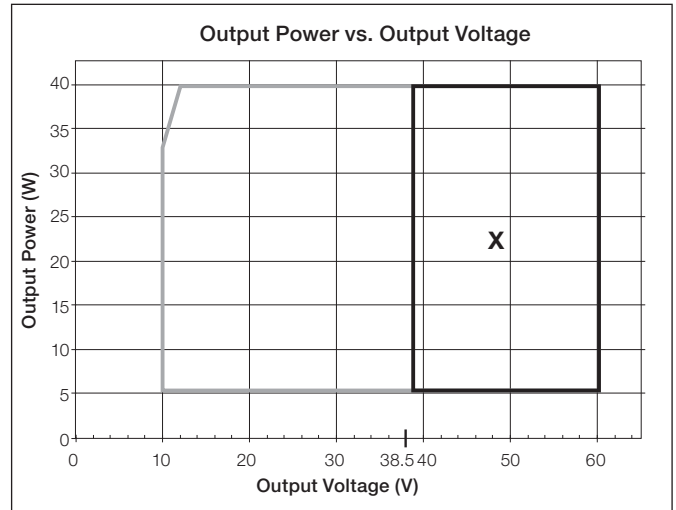
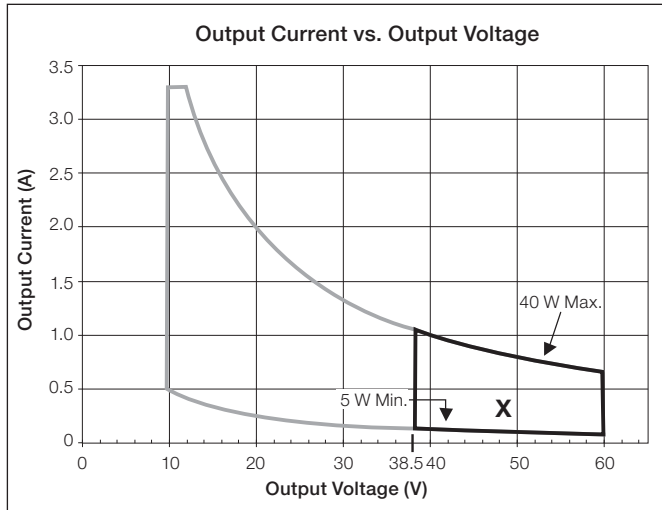

Typical Performance Specifications:

Parameter	120 V~	240 V~	277 V~	Test Conditions
Input Current	380 mA	190 mA	170 mA	t _a = 25 °C, 60.0 V 40 W load, Maximum Light Output, K-case
Power Factor	0.99	0.99	0.98	
THD	7%	6%	8%	
Driver Efficiency	88%	89%	89%	

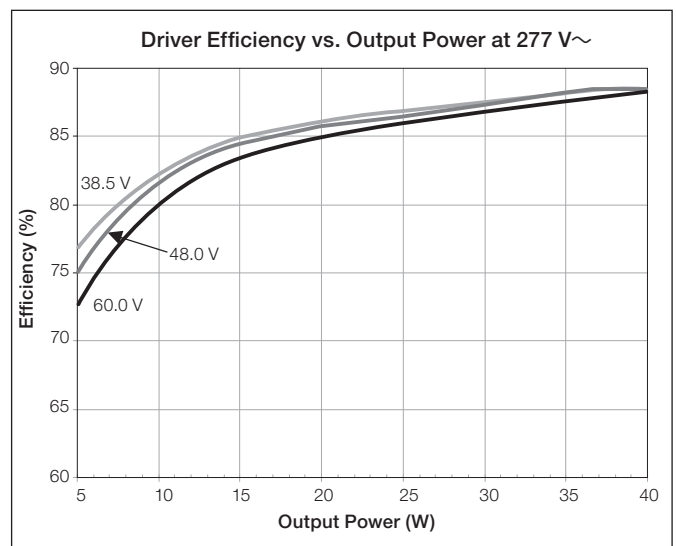
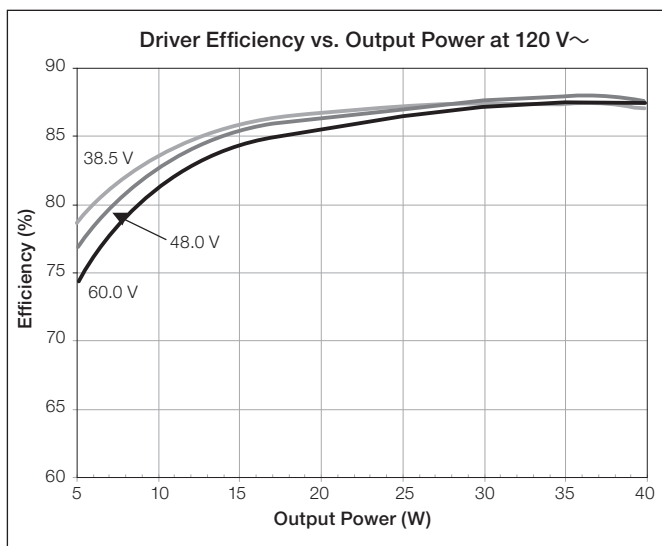

Job Name:	Model Numbers:
Job Number:	

“Y” Output Range, Current Driver Models

Driver Type	Output Dimming Method	Output Voltage	Output Current	Output Power	Standards Recognition	UL® Listed Option (KL case)
Constant-Voltage Driver (Isolated, Non-Class 2)	Pulse Width Modulation (PWM)	30–60 V PWM	0.20–0.50 A	6–30 W	 Type TL 83 °/65 °C - K-case Type TL 89 °/72 °C - M-case	No
	Constant-Current Reduction (CCR)	30–60 V \sim				

When using QwikFig™ technology, these models can be built from the following bulk units:

K-case - L3DA4U1UKx-1ABLK*; M-case - L3DA4U1UMN-1ABLK

* x = studded (S) or non-studded (N)

Current Driver Operation Range:

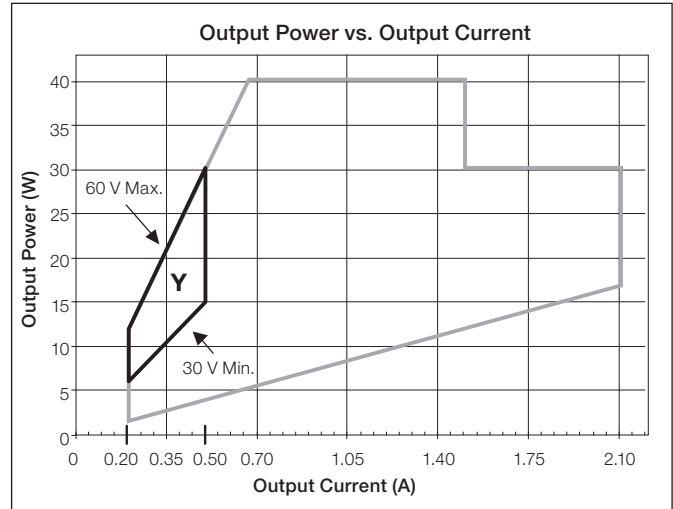
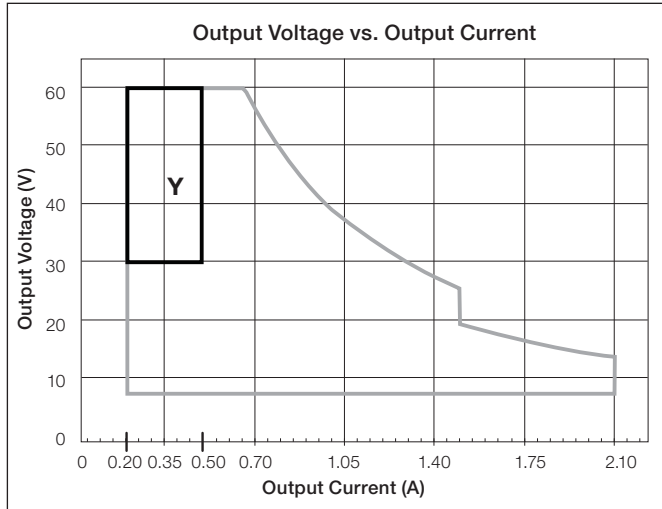

Typical Performance Specifications:

Parameter	120 V \sim	240 V \sim	277 V \sim	Test Conditions
Input Current	280 mA	150 mA	120 mA	t _a = 25 °C, 0.50 A 30 W load, Maximum Light Output, K-case
Power Factor	0.99	0.98	0.97	
THD	8%	9%	9%	
Driver Efficiency	85%	86%	86%	

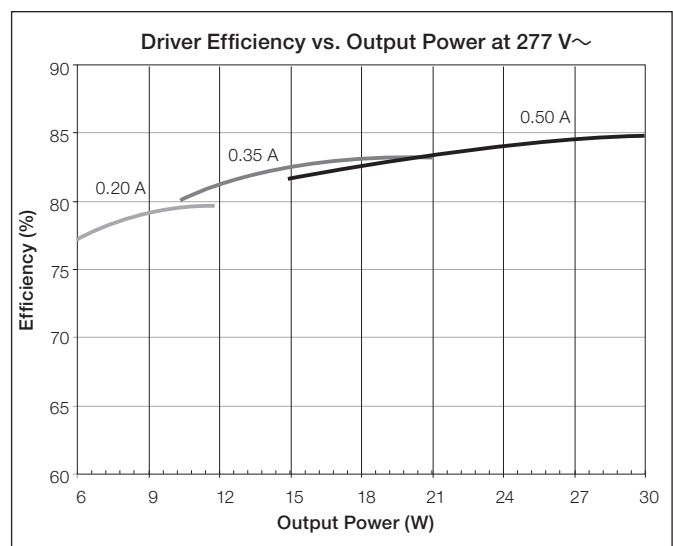
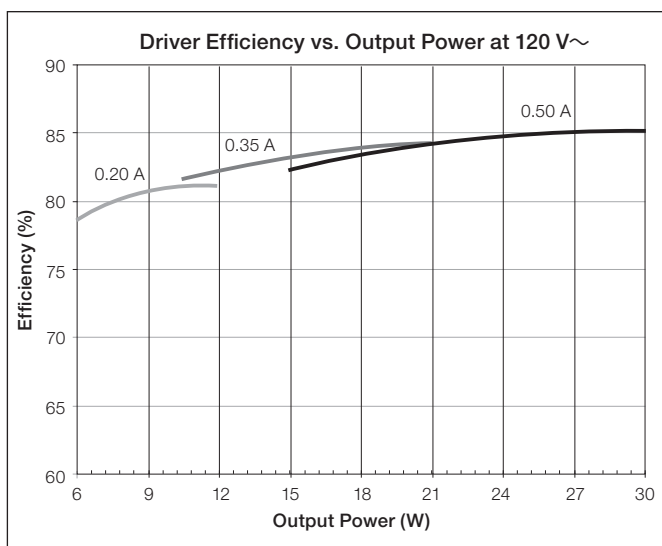

Job Name:	Model Numbers:
Job Number:	

“Z” Output Range, Current Driver Models

Driver Type	Output Dimming Method	Output Voltage	Output Current	Output Power	Standards Recognition	UL® Listed Option (KL case)
Constant-Voltage Driver (Isolated, Non-Class 2)	Pulse Width Modulation (PWM)	30–60 V PWM	0.51–1.00 A	16–40 W	 Type TL 83 °/65 °C - K-case Type TL 89 °/72 °C - M-case	No
	Constant-Current Reduction (CCR)	30–60 V \approx				

When using QwikFig™ technology, these models can be built from the following bulk units:

K-case - L3DA4U1UKx-1ABLK*; M-case - L3DA4U1UMN-1ABLK

* x = studded (S) or non-studded (N)

Current Driver Operation Range:

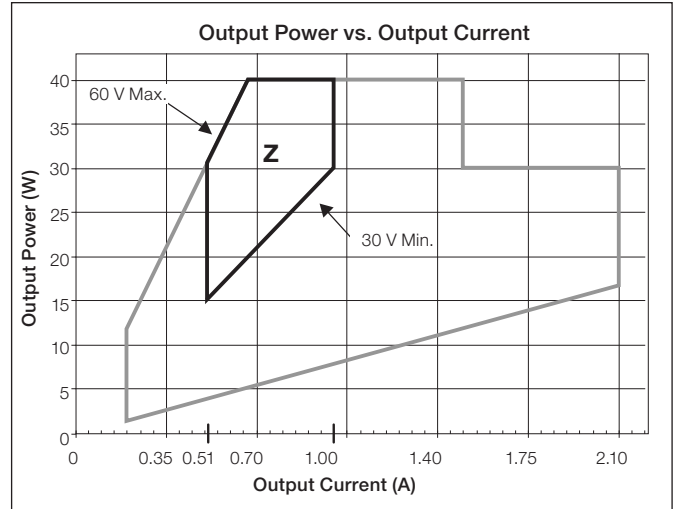
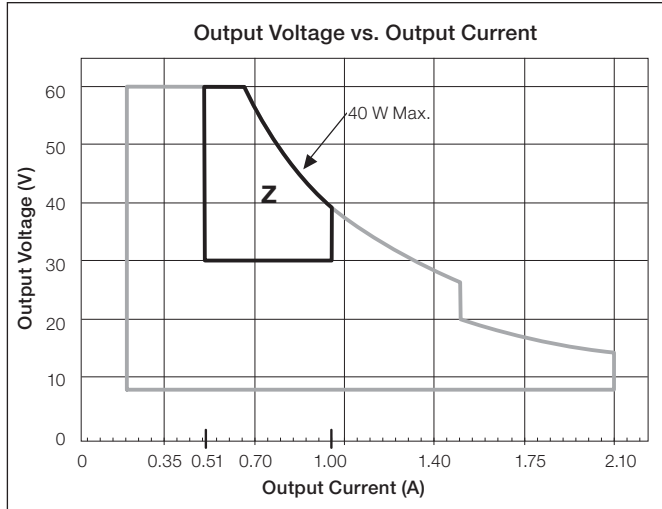

Typical Performance Specifications:

Parameter	120 V \sim	240 V \sim	277 V \sim	Test Conditions
Input Current	380 mA	200 mA	160 mA	t _a = 25 °C, 1.00 A 40 W load, Maximum Light Output, K-case
Power Factor	0.99	0.99	0.98	
THD	10%	8%	8%	
Driver Efficiency	84%	86%	86%	

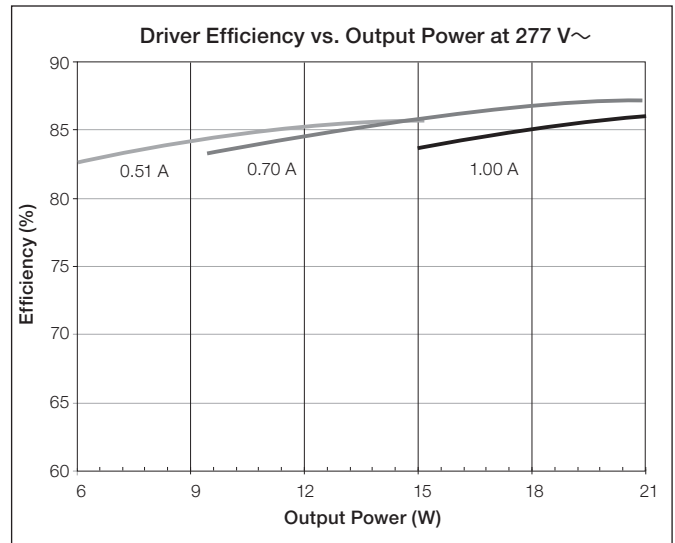
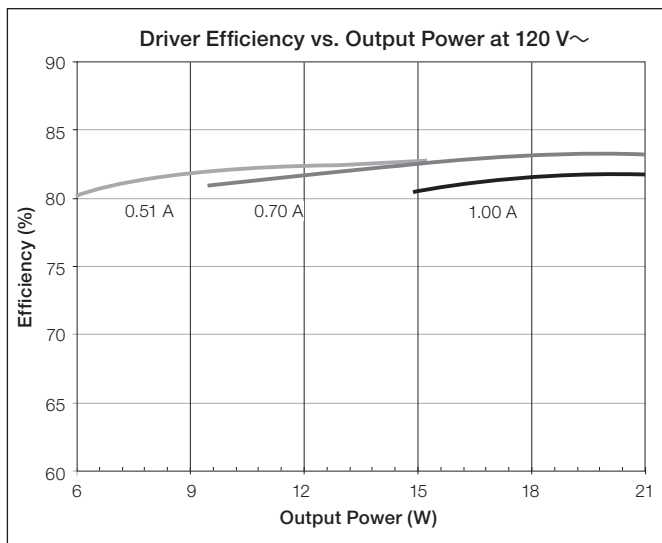

Job Name:	Model Numbers:
Job Number:	

Bulk Model Coverage - K-Case Model Numbers

For use with Lutron® QwikFig™ technology

3ABLK Operation Range:

Bulk Model	Driver Type	Output Dimming Method	Output Voltage	Output Current	Output Power	Standards Recognition
3ABLK	Constant-Current Driver (Class 2)	Constant-Current Reduction (CCR)	30–54 V _{DC}	0.20–1.00 A	6–40 W	 UL Type TL 83 °/66 °C

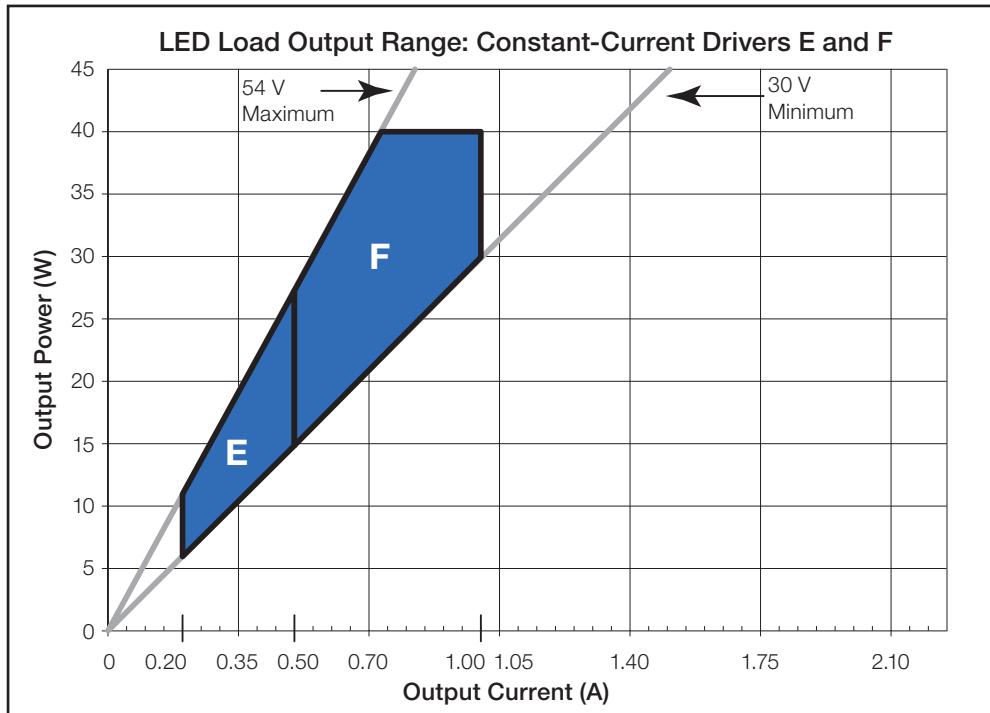



3A = Covers “LED Load Output Range” E and F (CCR dimming only)

Job Name:	Model Numbers:
Job Number:	

Bulk Model Coverage - K-Case Model Numbers (continued)
 For use with Lutron® QwikFig™ technology

2HBLK and 2SBLK Operation Range:

Bulk Model	Driver Type	Output Dimming Method	Output Voltage	Output Current	Output Power	Standards Recognition
2HBLK	Constant-Current Driver (Class 2)	Pulse Width Modulation (PWM)	15–38 V PWM	0.20–0.70 A	3–26.6 W	 Type TL 89 °/61 °C
		Constant-Current Reduction (CCR)	15–38 V==			
2SBLK	Constant-Current Driver (Class 2)	Pulse Width Modulation (PWM)	15–38 V PWM	0.71–1.50 A	11–40 W	 Type TL 86 °/69 °C
		Constant-Current Reduction (CCR)	15–38 V==			

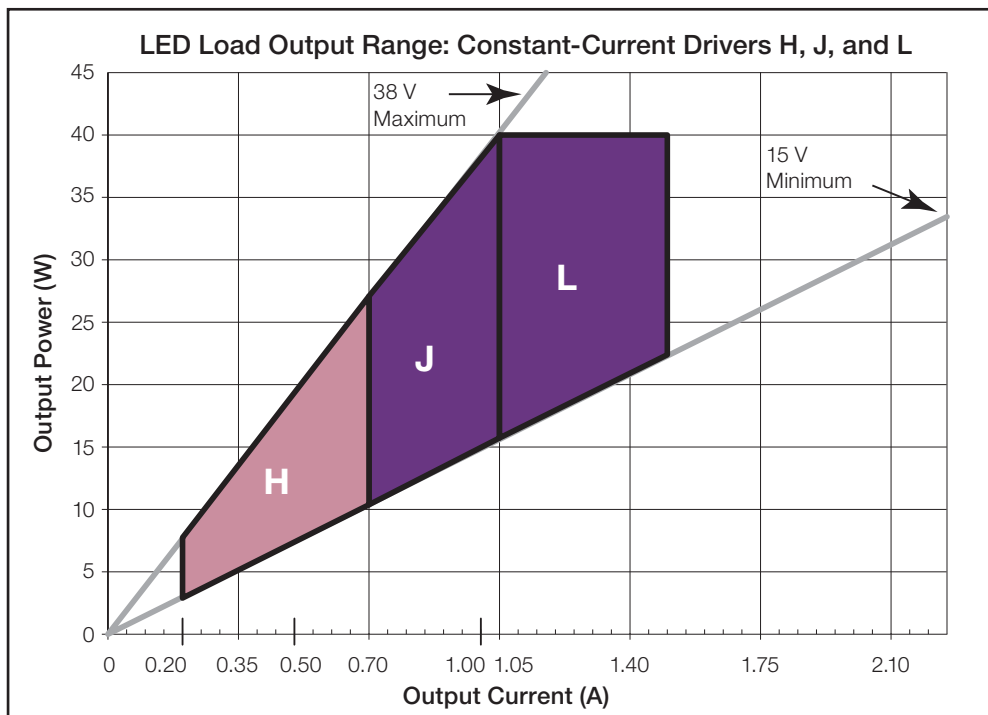



2H = Covers “LED Load Output Range” H
 2S = Covers “LED Load Output Range” J and L

Job Name:	Model Numbers:
Job Number:	

Bulk Model Coverage - K-Case Model Numbers (continued)
 For use with Lutron® QwikFig™ technology

2GBLK, 2RBLK, and 2ABLK Operation Range:

Bulk Model	Driver Type	Output Dimming Method	Output Voltage	Output Current	Output Power	Standards Recognition
2GBLK	Constant-Current Driver (Class 2)	Pulse Width Modulation (PWM)	8–20 V PWM	0.20–0.70 A	2–14 W	 Type TL 87 °/55 °C
		Constant-Current Reduction (CCR)	8–20 V=			
2RBLK	Constant-Current Driver (Class 2)	Pulse Width Modulation (PWM)	8–20 V PWM	0.71–1.50 A	6–30 W	 Type TL 86 °/63 °C
		Constant-Current Reduction (CCR)	8–20 V=			
2ABLK	Constant-Current Driver (Class 2)	Pulse Width Modulation (PWM)	8–19.9 V PWM	1.51–2.10 A	12–30 W	 Type TL 89 °/67 °C
		Constant-Current Reduction (CCR)	8–19.9 V=			

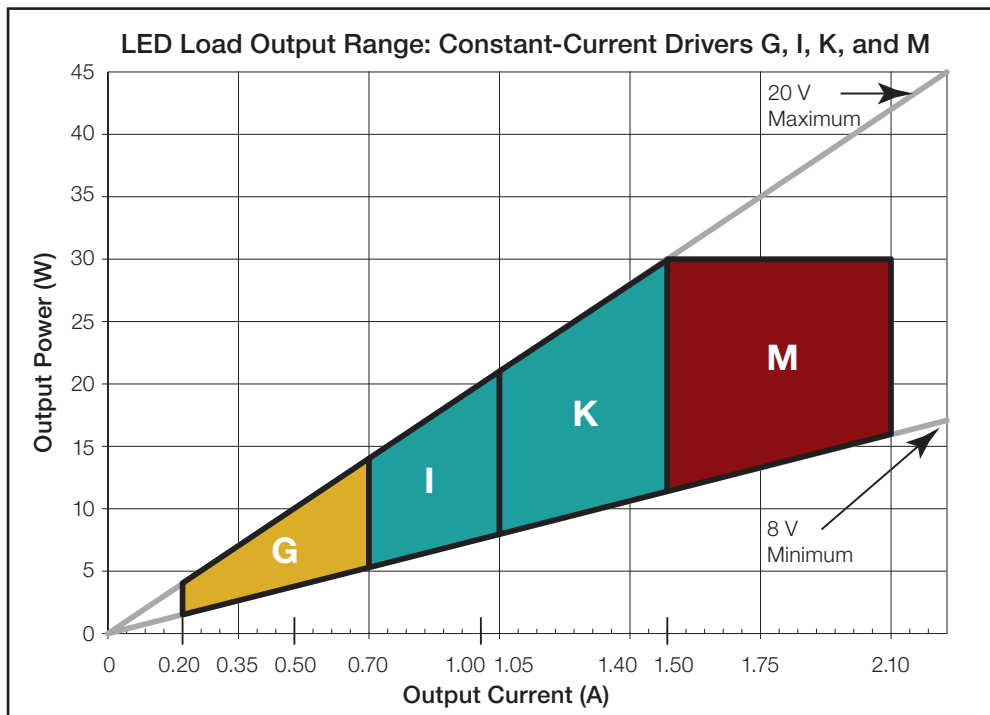

- 2G = Covers “LED Load Output Range” G
- 2R = Covers “LED Load Output Range” I and K
- 2A = Covers “LED Load Output Range” M

Job Name:	Model Numbers:
Job Number:	

Bulk Model Coverage - K-Case Model Numbers (continued)
 For use with Lutron® QwikFig™ technology

1ABLK Operation Range:

Bulk Model	Driver Type	Output Dimming Method	Output Voltage	Output Current	Output Power	Standards Recognition
1ABLK	Constant-Current Driver (Isolated, Non-Class 2)	Pulse Width Modulation (PWM)	30–60 V PWM	0.20–1.00 A	6–40 W	 Type TL 83 °/65 °C
		Constant-Current Reduction (CCR)	30–60 V==			

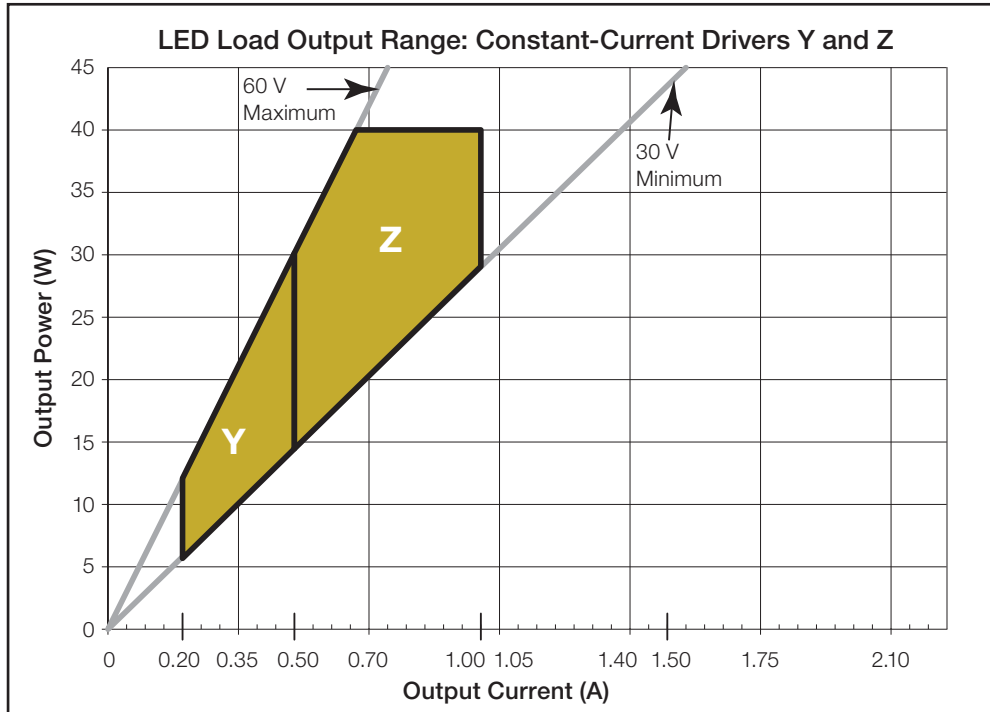

1A = Covers “LED Load Output Range” Y and Z

Job Name:	Model Numbers:
Job Number:	

Bulk Model Coverage - K-Case Model Numbers (continued)
 For use with Lutron® QwikFig™ technology

3BBLK Operation Range:

Bulk Model	Driver Type	Output Dimming Method	Output Voltage	Output Current	Output Power	Standards Recognition
3BBLK	Constant-Current Driver (Class 2)	Constant-Current Reduction (CCR)	35–54 V _{DC}	0.71–1.05 A	25–53 W	 Type TL 87 °/71 °C

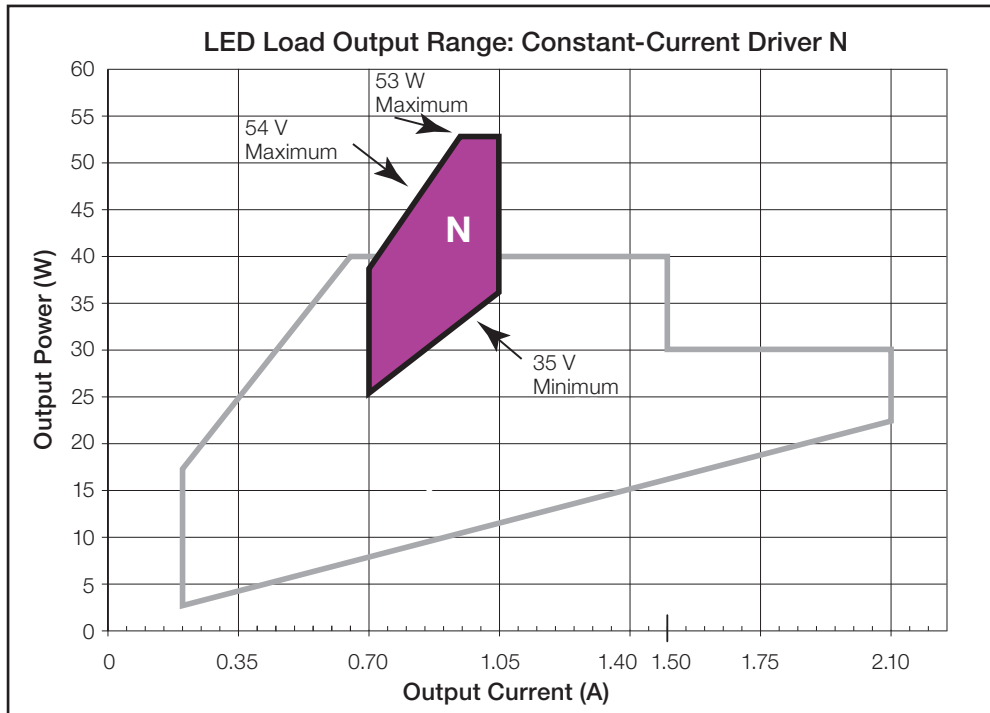

3B = Covers “LED Load Output Range” N

Job Name:	Model Numbers:
Job Number:	

Bulk Model Coverage - K-Case Model Numbers (continued)
 For use with Lutron® QwikFig™ technology

1BBLK Operation Range:

Bulk Model	Driver Type	Output Dimming Method	Output Voltage	Output Current	Output Power	Standards Recognition
1BBLK	Constant-Current Driver (Isolated, Non-Class 2)	Pulse Width Modulation (PWM)	35–60 V PWM	0.71–1.05 A	25–53 W	 Type TL 85 °/71 °C
		Constant-Current Reduction (CCR)	35–60 V==			

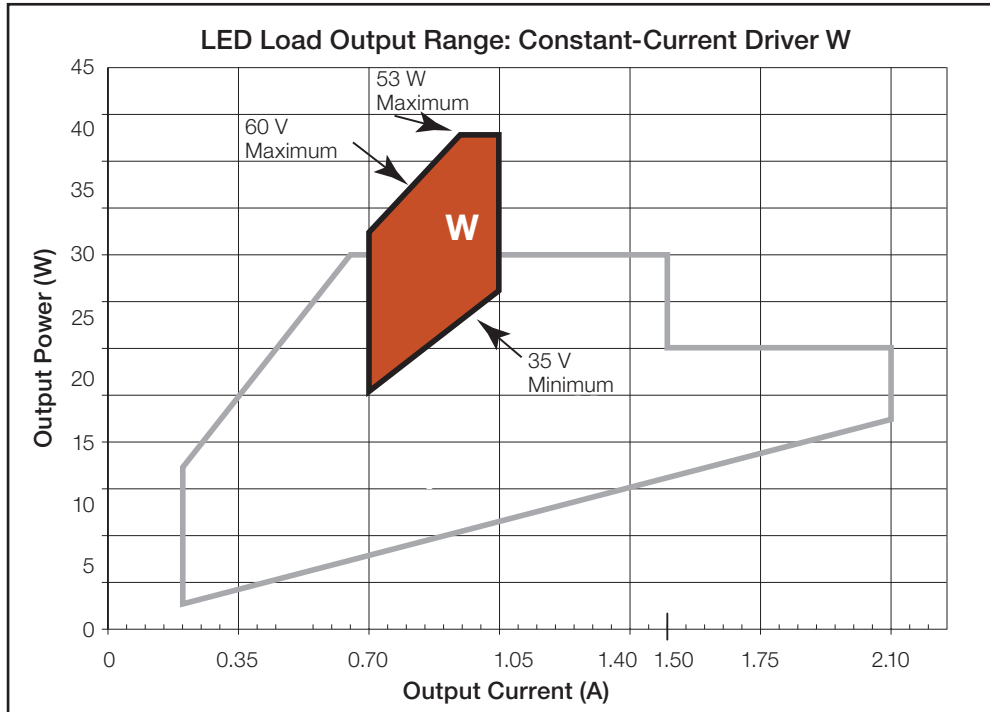

1B = Covers “LED Load Output Range” W

Job Name:	Model Numbers:
Job Number:	

Bulk Model Coverage - M-Case Model Numbers
 For use with Lutron® QwikFig™ technology

3ABLK Operation Range:

Bulk Model	Driver Type	Output Dimming Method	Output Voltage	Output Current	Output Power	Standards Recognition
3ABLK	Constant-Current Driver (Class 2)	Constant-Current Reduction (CCR)	30–54 V _{DC}	0.20–1.00 A	6–40 W	 Type TL 90 °/72 °C

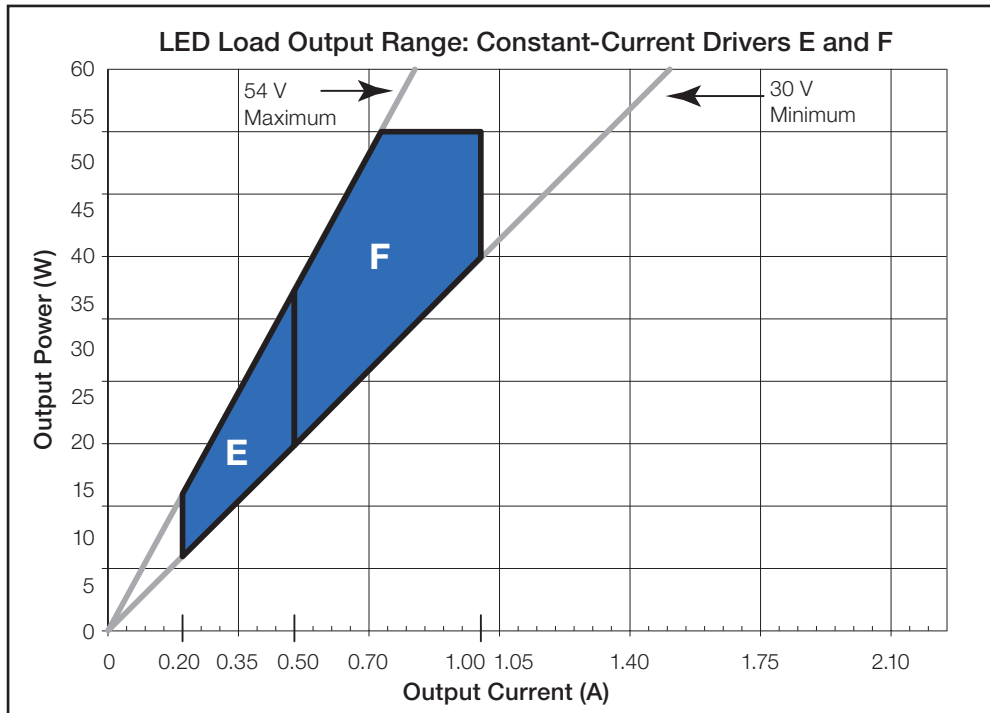

3A = Covers “LED Load Output Range” E and F (CCR dimming only)

Job Name:	Model Numbers:
Job Number:	

Bulk Model Coverage - M-Case Model Numbers (continued)
 For use with Lutron® QwikFig™ technology

2BBLK Operation Range:

Bulk Model	Driver Type	Output Dimming Method	Output Voltage	Output Current	Output Power	Standards Recognition
2BBLK	Constant-Current Driver (Class 2)	Pulse Width Modulation (PWM)	15–38 V PWM	0.20–1.50 A	3–40 W	 Type TL 89 °/74 °C
		Constant-Current Reduction (CCR)	15–38 V==			

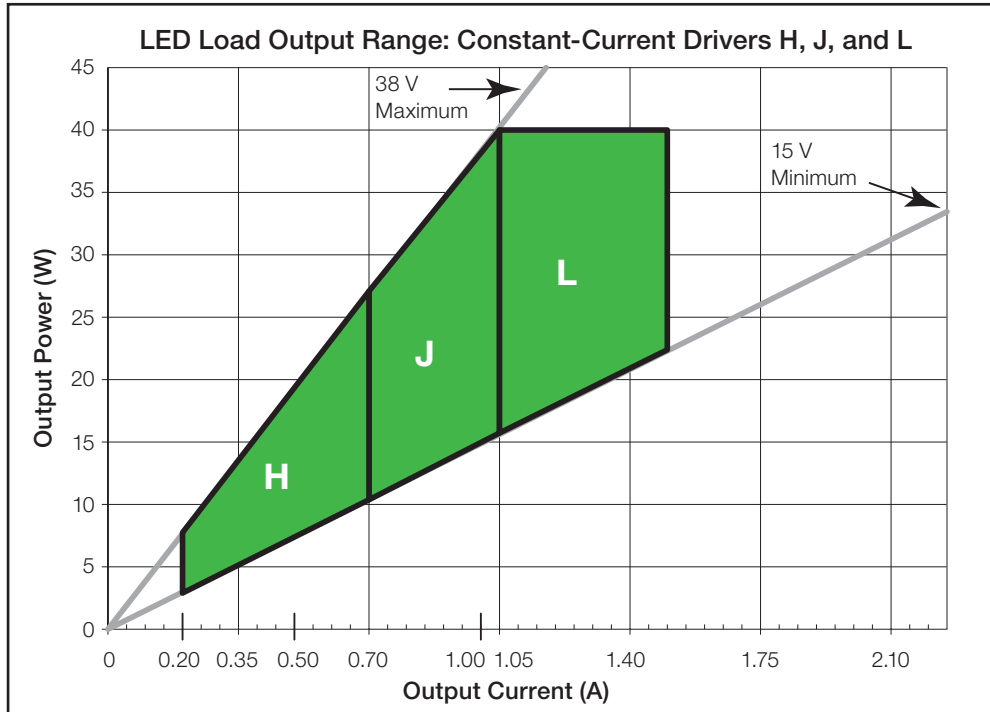



2B = Covers “LED Load Output Range” H, J, and L

Job Name:	Model Numbers:
Job Number:	

Bulk Model Coverage - M-Case Model Numbers (continued)
 For use with Lutron® QwikFig™ technology

2CBLK and 2ABLK Operation Range:

Bulk Model	Driver Type	Output Dimming Method	Output Voltage	Output Current	Output Power	Standards Recognition
2CBLK	Constant-Current Driver (Class 2)	Pulse Width Modulation (PWM)	8–20 V PWM	0.20–1.50 A	2–30 W	 Type TL 89 °/68 °C
		Constant-Current Reduction (CCR)	8–20 V==			
2ABLK	Constant-Current Driver (Class 2)	Pulse Width Modulation (PWM)	8–19.9 V PWM	1.51–2.10 A	12–30 W	 Type TL 89 °/71 °C
		Constant-Current Reduction (CCR)	8–19.9 V==			

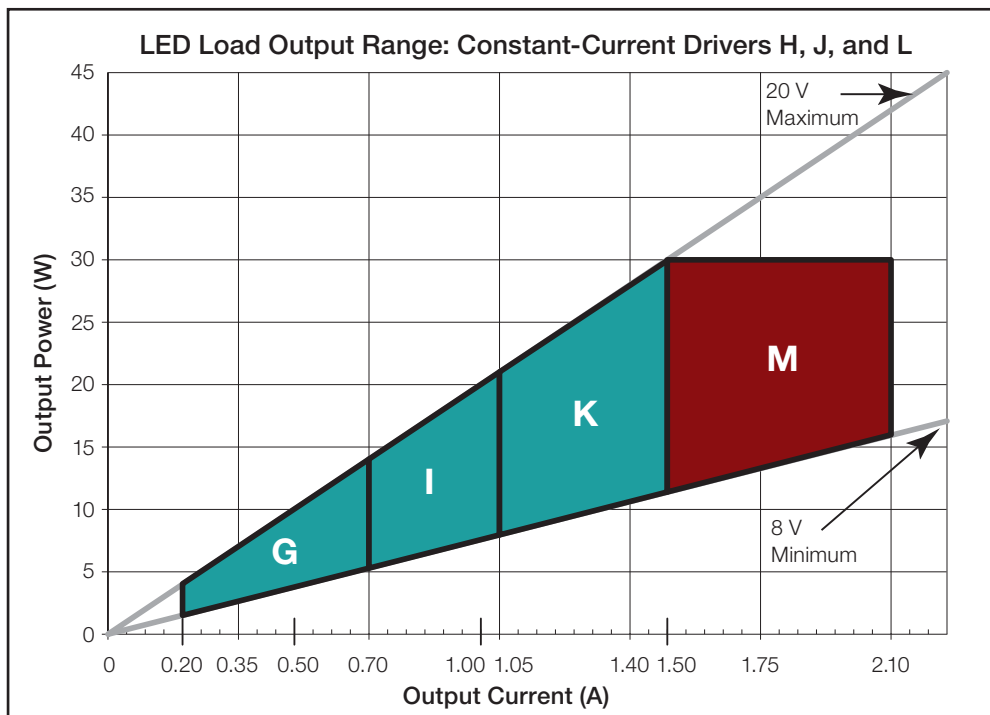

2C = Covers “LED Load Output Range” G, I, and K
 2A = Covers “LED Load Output Range” M

Job Name:	Model Numbers:
Job Number:	

Bulk Model Coverage - M-Case Model Numbers (continued)
 For use with Lutron® QwikFig™ technology

1ABLK Operation Range:

Bulk Model	Driver Type	Output Dimming Method	Output Voltage	Output Current	Output Power	Standards Recognition
1ABLK	Constant-Current Driver (Isolated, Non-Class 2)	Pulse Width Modulation (PWM)	30–60 V PWM	0.20–1.00 A	6–40 W	 Type TL 89 °/72 °C
		Constant-Current Reduction (CCR)	30–60 V==			

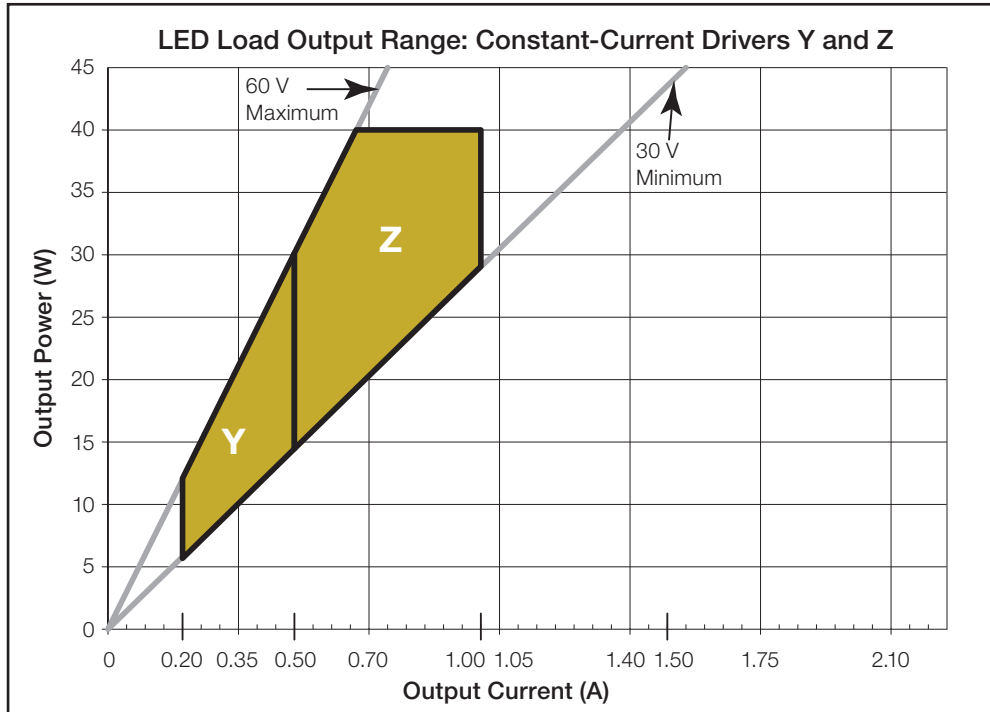

1A = Covers “LED Load Output Range” Y and Z

Job Name:	Model Numbers:
Job Number:	

K-Case: Case Dimensions

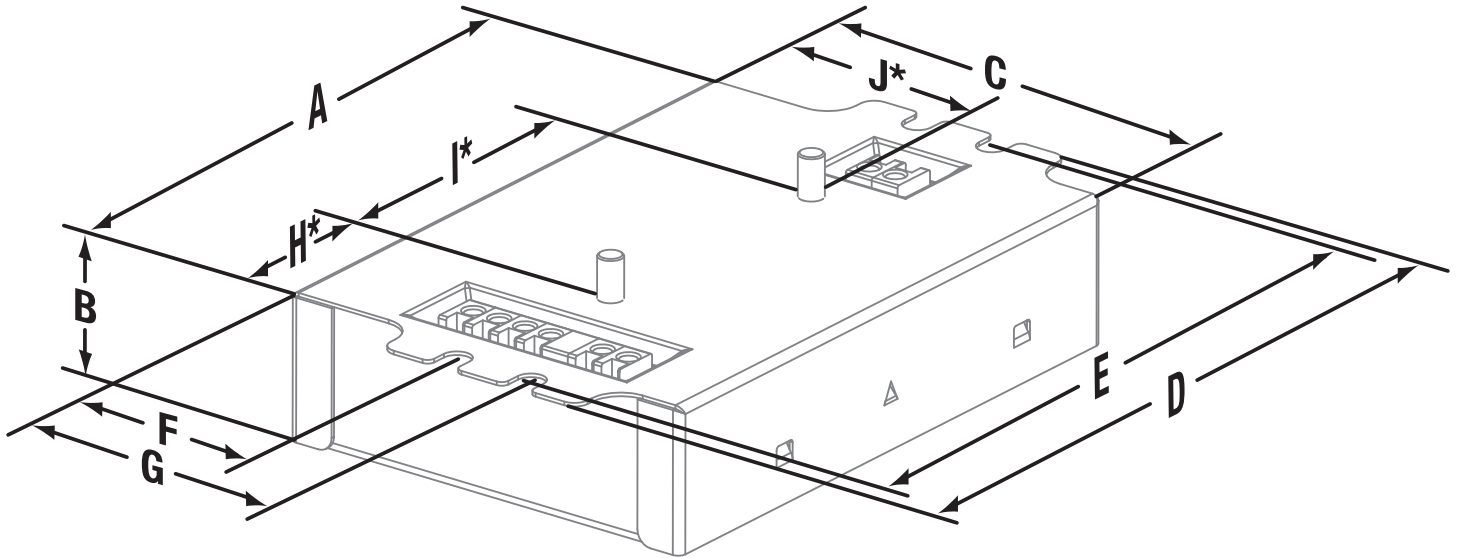

K-Case: Connector Location Dimensions

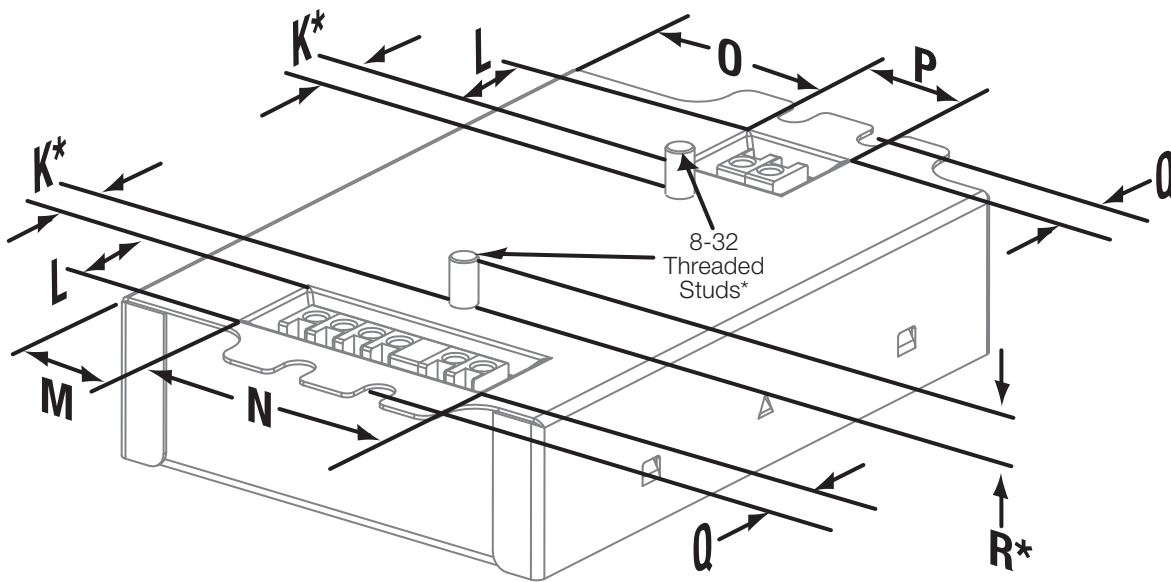

A	4.20 in (107 mm)	F	1.42 in (36 mm)	K*	0.33 in (8.3 mm)	P	0.74 in (19 mm)
B	1.00 in (25 mm)	G	1.99 in (51 mm)	L	0.65 in (16.5 mm)	Q	0.32 in (8 mm)
C	3.00 in (76 mm)	H*	1.11 in (28 mm)	M	0.75 in (19 mm)	R*	0.29 in (7 mm)
D	4.90 in (124 mm)	I*	2.00 in (51 mm)	N	1.73 in (44 mm)		
E	4.60 in (117 mm) (mounting center)	J*	1.60 in (41 mm)	O	1.33 in (34 mm)		

* Applies to studded K-case only.

Job Name:	Model Numbers:
Job Number:	

K-Case: Side Entry Connector Location Dimensions (Non-Studded)

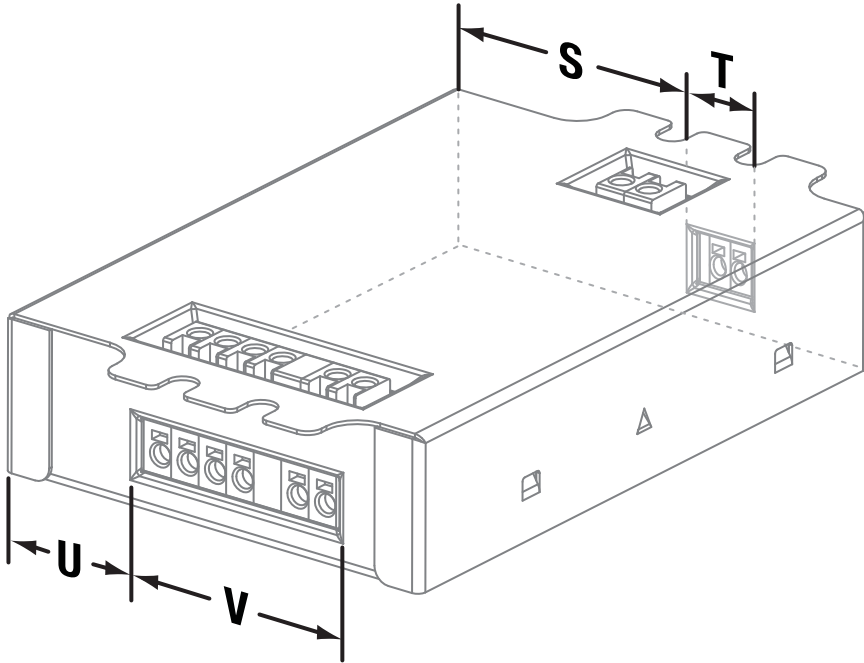

S	1.38 in (35 mm)
T	0.64 in (16 mm)
U	0.88 in (22 mm)
V	1.53 in (39 mm)

M-Case: Case Dimensions

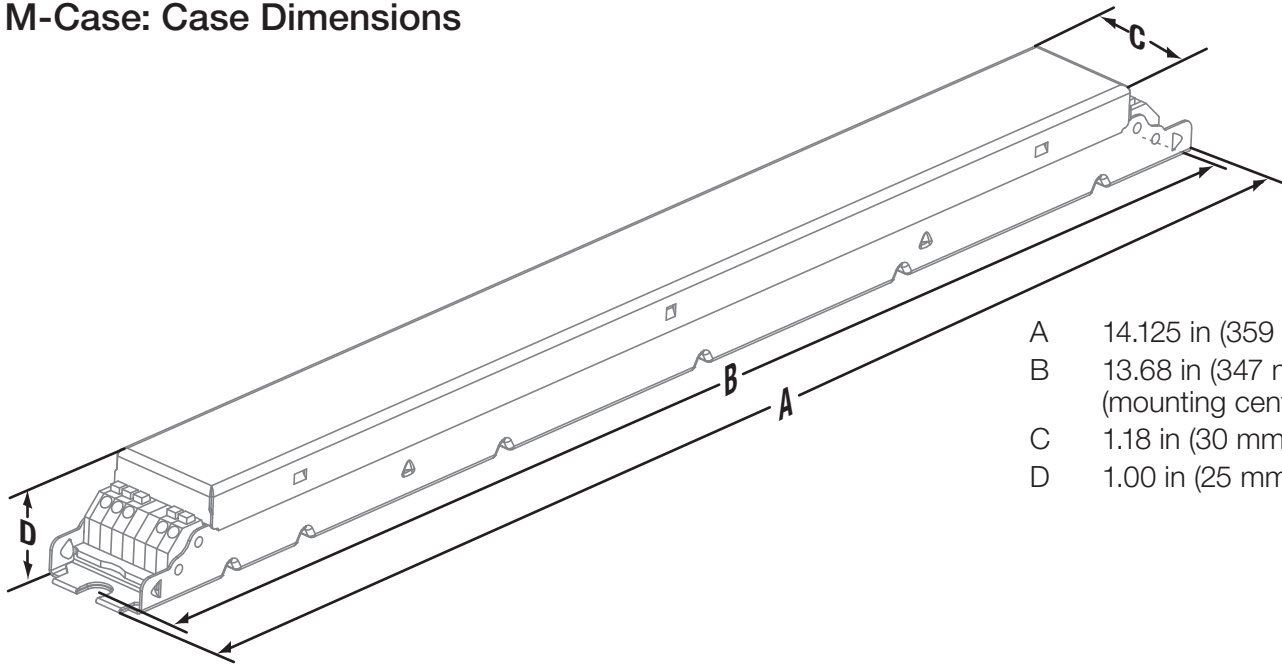

A	14.125 in (359 mm)
B	13.68 in (347 mm) (mounting center)
C	1.18 in (30 mm)
D	1.00 in (25 mm)

Job Name:	Model Numbers:
Job Number:	

KL Case: Case Dimensions

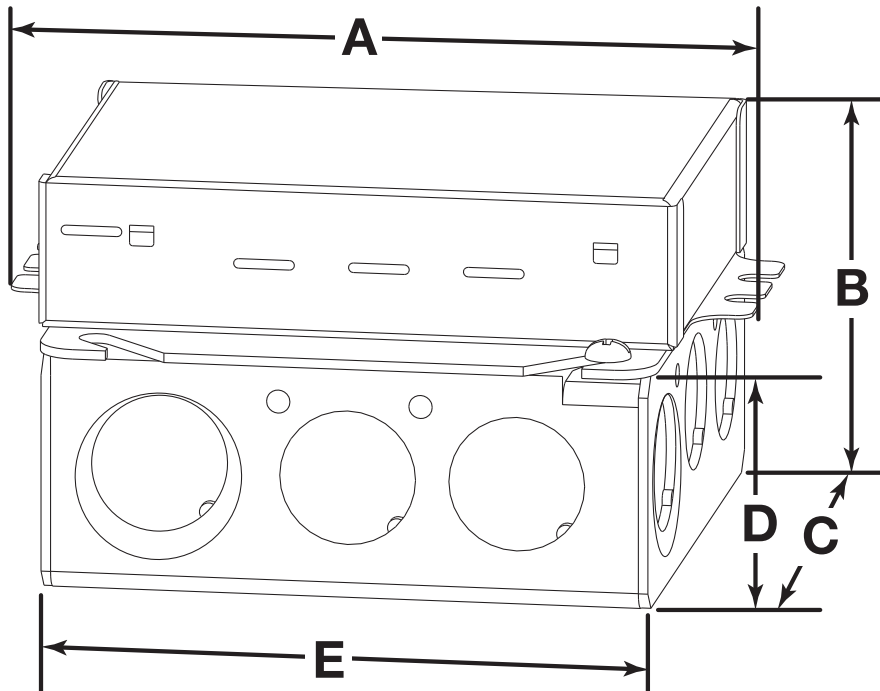

A	4.89 in (124 mm)
B	2.62 in (66 mm)
C	4.00 in (102 mm)
D	1.62 in (41 mm)
E	4.00 in (102 mm)

KL case includes a 4 in (102 mm) square junction box which complies with NEMA® OS 1-2008 Figure 112.

Knockouts

- Sides
 - 8 locations: 0.5 in (13 mm)
 - 4 locations: 0.5/0.75 in (13/19 mm)
- Bottom
 - 2 locations: 0.5 in (13 mm)
 - 2 locations: 0.5/0.75 in (13/19 mm)

Driver Wiring and Mounting

- Driver is grounded by the green ground wire connection on the enclosure or by the ground lug terminal in the junction box
- Driver and junction box must be grounded in accordance with local and national electrical codes
- All wire connections must be made in the junction box to maintain UL® listing
- 4 in (102 mm) square junction box is 1.5 in (38 mm) deep with 22.0 in³ (360.5 cm³) capacity and complies with NEMA® OS 1-2008 Figure 112
- Driver is pre-wired with 6 in (152 mm), 18 AWG (0.75 mm²) solid copper leads in all terminal blocks

Job Name:

Model Numbers:

Job Number:

Wiring Diagram for 3-Wire Control

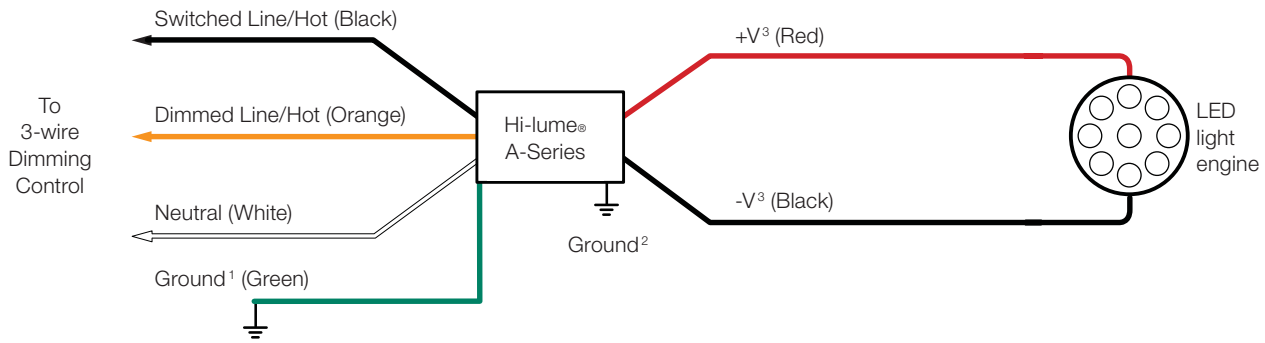

Wiring Diagram for EcoSystem® Digital Control

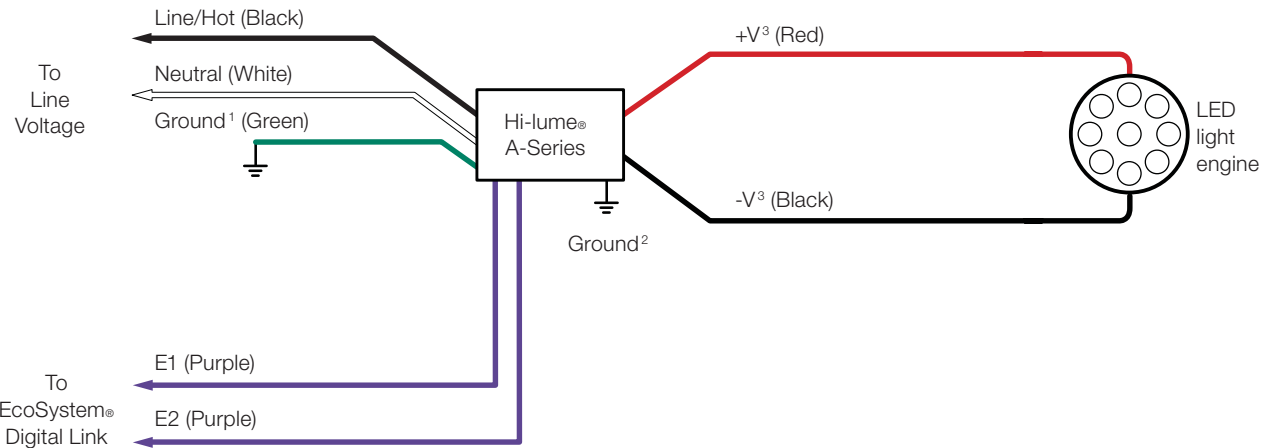

Note: Colors shown correspond to terminal blocks on driver.

¹ Ground wire connection available on K-case models only.
² Fixture and driver case must be grounded in accordance with local and national electrical codes.
³ For maximum driver-to-LED light engine wire length, see charts in **Driver Leads** section at the end of the document.

Job Name:	Model Numbers:
Job Number:	

Compatible Controls

- Guaranteed performance specifications with the controls listed in the chart below.
- For assistance selecting controls, contact our LED Center of Excellence at 1.877.346.5338 or LEDs@lutron.com

Product	Part Number		Drivers per Control				Measured Light Output Range
			40 W Driver		50 W Driver		
	120 V~	277 V~	120 V~	277 V~	120 V~	277 V~	
3-wire Controls: Requires 3rd wire for control signal, see 3-wire diagram on previous page							
Nova T ⁵ ®	NTF-10-	NTF-10-277-	1-41	1-44	1-31	1-36	100%-1%
	NTF-103P-	NTF-103P-277-	1-20	1-33	1-15	1-27	100%-1%
Nova®	NF-10-	NF-10-277-	1-41	1-44	1-31	1-36	100%-1%
	NF-103P-	NF-103P-277-	1-20	1-33	1-15	1-27	100%-1%
Vareo®	VF-10-	–	1-20	–	1-15	–	100%-1%
Skylark®	SF-10P-	SF-12P-277-	1-20	1-33	1-15	1-27	100%-1%
	SF-103P-	SF-12P-277-3	1-20	1-33	1-15	1-27	100%-1%
Diva®	DVF-103P-	DVF-103P-277-	1-20	1-33	1-15	1-27	100%-1%
	DVSCF-103P-	DVSCF-103P-277-	1-20	1-33	1-15	1-27	100%-1%
Ariadni®	AYF-103P-	AYF-103P-277-	1-20	1-44	1-15	1-27	100%-1%
Vierti®	VTF-6A-		1-15	1-33	1-11	1-27	100%-1%
Maestro®	MAF-6AM-	MAF-6AM-277-	1-15	1-20	1-11	1-20	100%-1%
	MSCF-6AM-	MSCF-6AM-277-	1-15	1-20	1-11	1-20	100%-1%
Maestro Wireless®	MRF2-F6AN-DV-		1-15	1-33	1-11	1-27	100%-1%
RadioRA® 2	RRD-F6AN-DV-		1-15	1-33	1-11	1-27	100%-1%
HomeWorks® QS	HQRD-F6AN-DV		1-15	1-33	1-11	1-27	100%-1%
Interfaces ¹	PHPM-3F-120	–	1-41	–	1-31	–	100%-1%
	PHPM-3F-DV		1-41	1-88	1-31	1-72	100%-1%
GP Dimming Panels	Various		1-41	1-88	1-31	1-72	100%-1%
EcoSystem® Controls: See EcoSystem® Controls wiring diagram on previous page							
PowPak® dimming module with EcoSystem®	RMJ-ECO32-DV-B		32 per EcoSystem® link				100%-1%
Energi Savr Node™ with EcoSystem®	QSN-1ECO-S, QSN-2ECO-S		64 per EcoSystem® link				100%-1%
GRAFIK Eye® QS with EcoSystem®	QSGRJ-_E, QSGRJ-_E	–	64 per EcoSystem® link				100%-1%
Quantum®	Various		64 per EcoSystem® link				100%-1%

¹ For use with 3-wire controls or Commercial Systems, RadioRA® 2 Systems or Home Systems applications.

Job Name:	Model Numbers:
Job Number:	

EcoSystem® Wiring Diagrams

EcoSystem® Digital Link Overview

- The EcoSystem® Digital Link wiring (E1 and E2) connects the digital ballasts and drivers together to form a lighting control system.
- Each EcoSystem® Digital Link supports up to 64 digital ballasts, LED drivers or EcoSystem® Modules (e.g. C5-BMJ-16A, C5-XPJ-16A), 32 occupancy sensors (64 occupancy sensors with Energi Savr Node™ with EcoSystem®), 16 daylight sensors, and 64 wallstations or IR receivers.*
- Sensors do not directly connect to Hi-lume® A-Series LED drivers.
- E1 and E2 (EcoSystem® digital link wires) are polarity insensitive and can be wired in any topology.
- An Energi Savr Node™ unit with EcoSystem®, GRAFIK Eye® QS control unit with EcoSystem®, PowPak® dimming module with EcoSystem®, or Quantum® system provides power for the EcoSystem® Digital Link and supports system programming.*
- All EcoSystem® Digital Link programming is completed by using the Energi Savr app for *Apple iPad*, *iPod Touch* or *iPhone* mobile digital devices, GRAFIK Eye® QS with EcoSystem®, PowPak® dimming module with EcoSystem®, or Quantum® system.

EcoSystem® Digital Link Wiring

- Driver EcoSystem® Digital Link terminals only accept one 18 AWG to 16 AWG (0.75 mm² to 1.5 mm²) solid copper wire per terminal.
- Make sure that the supply breaker to the Digital Driver and EcoSystem® Digital Link Supply is OFF when wiring.
- Connect the two conductors to the two Digital Driver terminals E1 and E2 as shown.
- Using two different colors for E1 and E2 will reduce confusion when wiring several drivers together.
- The EcoSystem® Digital Link may be wired Class 1 or Class 2. Consult applicable electrical codes for proper wiring practices.

* PowPak® dimming module with EcoSystem® provides power for the EcoSystem® Digital Link and can support 32 digital ballasts, LED drivers or EcoSystem® Modules, 6 Wireless Occupancy Sensors, 1 Wireless Daylight Sensor, and 9 Pico® Wireless Controllers.

Apple, iPad, iPod Touch, and iPhone are trademarks of Apple Inc., registered in the U.S. and other countries.

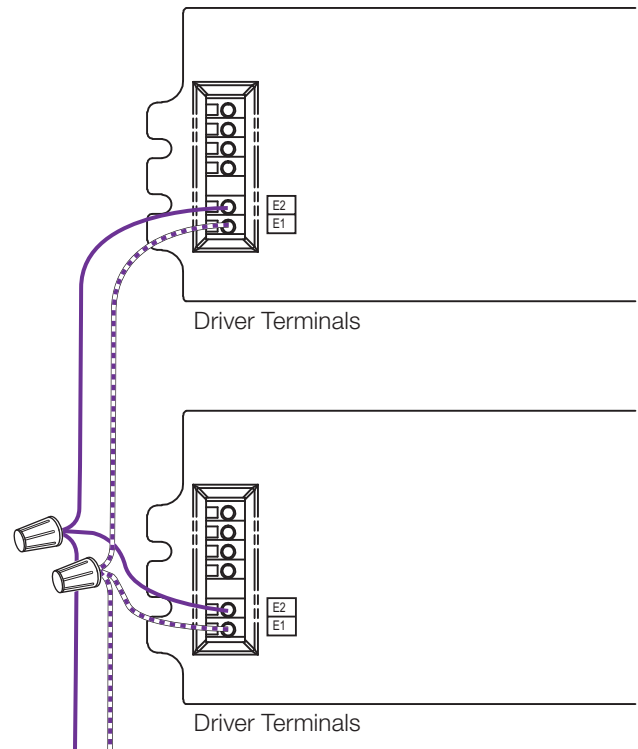

To the EcoSystem® Digital Bus and additional drivers and/or ballasts

Notes

- The EcoSystem® Digital Link Supply does not have to be located at the end of the Digital Link.
- EcoSystem® Digital Link length is limited by the wire gauge used for E1 and E2 as follows:

Wire Gauge	Digital Link Length (max)
12 AWG	2200 ft
14 AWG	1400 ft
16 AWG	900 ft
18 AWG	550 ft

Wire Size	Digital Link Length (max)
4.0 mm ²	828 m
2.5 mm ²	517 m
1.5 mm ²	310 m
1.0 mm ²	207 m
0.75 mm ²	155 m

Job Name:	Model Numbers:
Job Number:	

ELECTRICIANS AND CONTRACTORS

Driver Leads

Maximum driver-to-LED light engine wire length for
Constant-Current Drivers:

Wire Gauge	Maximum Lead Length		
	200 mA to 700 mA	710 mA to 1.50 A	1.51 A to 2.10 A
18 AWG (0.75 mm ²)	30 ft (9 m)	15 ft (4.5 m)	10 ft (3 m)
16 AWG (1.5 mm ²)	35 ft (10.5 m)	25 ft (7.5 m)	15 ft (4.5 m)
14 AWG (2.5 mm ²)	50 ft (15 m)	40 ft (12 m)	25 ft (7.5 m)
12 AWG (4.0 mm ²)	100 ft (30 m)	60 ft (18 m)	40 ft (12 m)

Maximum driver-to-LED light engine wire length for
Constant-Voltage Drivers:

Wire Gauge	Maximum Lead Length		
	10 V to 20 V	20.5 V to 40 V	40.5 V to 60 V
18 AWG (0.75 mm ²)	10 ft (3 m)	15 ft (4.5 m)	30 ft (9 m)
16 AWG (1.5 mm ²)	15 ft (4.5 m)	25 ft (7.5 m)	50 ft (15 m)
14 AWG (2.5 mm ²)	25 ft (7.5 m)	40 ft (12 m)	75 ft (22.5 m)
12 AWG (4.0 mm ²)	40 ft (12 m)	60 ft (18 m)	100 ft (30 m)

Wiring and Grounding

Driver and lighting fixture must be grounded.
Drivers must be installed per national and local
electrical codes.

LED Load Replacement

For Class 2 rated drivers, the LED load can be
changed while the driver is installed and powered.

Maximum Driver Operating Temperature

Driver case temperature (t_c) must not exceed UL®
conditions of acceptability in end product.

For 50,000 hour lifetime, driver case temperature (t_c)
must not exceed:

- 149 °F (65 °C) for 40 W drivers.
- 158 °F (70 °C) for 50 W drivers.

FACILITIES MANAGERS

SERVICE

Warranty

For warranty information, please visit
www.lutron.com/ballastdriverwarranty

Replacement Parts

When ordering Lutron® replacement parts please
provide the full model number. Consult Lutron if you
have any questions.

Further Information

For further information, please visit us at
www.lutron.com/hilumeLED or contact our
LED Control Center of Excellence at 1.877.346.5338
or LEDs@lutron.com

Job Name:	Model Numbers:
Job Number:	