

LED T8 - LINEAR REPLACEMENT LAMP

Single-Ended/ Double-Ended Power
Coated Glass Series
UL TYPE-B



FEATURES:

- Wattage:
 - 9W, 2FT, ≥1125 lumens, replaces 17W fluorescent T8
 - 12W, 3FT, ≥1,225 lumens, replaces 25W fluorescent T8
 - 11.5W, 4FT, ≥1,650 lumens, replaces 32W fluorescent T8
- Universal Voltage: 120V-277V applications
- Color Rendering Index (CRI): ≥80
- Beam angle: 330°
- THD <20%
- Power factor: ≥ 0.90
- Easy retrofit into most common linear fluorescent fixtures
- Simple ballast bypass, single-ended/ double-ended power
- Single Ended Connection can be used with non-shunted lamp holders. Double Ended Connection can be used with shunted lamp holders.
- Instant on
- Mercury free and virtually no UV or IR light
- Suitable for enclosed fixture
- Suitable for dry and damp locations
- ETL Sanitation listed (tested under NSF standard)
- All glass construction with PET coating
- Rated Lifetime @ L70: 62,000 Hours
- Products L9T8DE235-CG4, L9T8DE240-CG4, L9T8DE250-CG4, L11.5T8DE435-CG4, L11.5T8DE440-CG4 & L11.5T8DE450-CG4 are listed on the DLC QPL

PRODUCT DESCRIPTION:

Offering the versatility of single or double ended wiring options in one product SKU, this LED UL Type-B T8 lamp is an easy retrofit into most common linear fluorescent fixtures. In addition to flexible installation features that save installers time and money, the Single-Ended/Double-Ended LED T8 lamp consumes up to 50% less energy than standard fluorescent tubes, providing facilities with long-term operational savings.

WARRANTY:

5-year standard warranty
(further details available at www.maxlite.com/warranties)
Product may be eligible for a warranty extension to 10 years, for an additional fee. Contact MaxLite for details.

MODEL SELECTION (Full list of order codes on pg. 2)			Typical order example: L9T8DE240-CG4		
L	9	T8	DE	2	
FAMILY	WATTAGE	LAMP TYPE	OPERATION	LENGTH	COLOR TEMPERATURE
L= LED Linear	9= 9W	T8= T8 tube	DE= Double-Ended Power	2= 2FT	35-CG4= 3500K, Coated Glass 40-CG4= 4000K, Coated Glass 50-CG4= 5000K, Coated Glass
L	12	T8	DE	3	
FAMILY	WATTAGE	LAMP TYPE	OPERATION	LENGTH	COLOR TEMPERATURE
L= LED Linear	12= 12W	T8= T8 tube	DE= Double-Ended Power	3= 3FT	35-CG4= 3500K, Coated Glass 40-CG4= 4000K, Coated Glass 50-CG4= 5000K, Coated Glass
L	11.5	T8	DE	4	
FAMILY	WATTAGE	LAMP TYPE	OPERATION	LENGTH	COLOR TEMPERATURE
L= LED Linear	11.5= 11.5W	T8= T8 tube	DE= Double-Ended Power	4= 4FT	35-CG4= 3500K, Coated Glass 40-CG4= 4000K, Coated Glass 50-CG4= 5000K, Coated Glass

Specifications are subject to change without notice.

SPECIFICATIONS:

		L9T8DE2xx-CG4	L12T8DE3xx-CG4	L11.5T8DE4xx-CG4
ITEM	SPECIFICATION	2FT - DETAILS	3FT - DETAILS	4FT - DETAILS
GENERAL PERFORMANCE	Power Consumption (W)	9W	12W	11.5W
	Lumens Delivered (lm)	1125-1188	1225-1300	1650-1800
	Efficacy	≥125 lm/w	≥102 lm/w	≥143 lm/w
	CRI	≥80		
	Beam Angle	330°		
	Color Temperature (CCT)	3500K, 4000K, 5000K		
	Lumen Maintenance (L70)	62,000 Hours		
ELECTRICAL	Power Factor	≥ 0.90		
	Input Voltage	120V-277V, 50/60 Hz		
PHYSICAL	Operating Temperature	-4°F to 113°F		
	Lens	Opal (Frosted) - Coated Glass		
CERTIFICATION	Certification	CULus Classified, ETL Sanitation	cULus Classified, ETL Sanitation	CULus Classified, ETL Sanitation
	Material Usage	RoHS compliant; no mercury		
	Environment	Dry & Damp, Enclosed Fixtures		
	Warranty	5-year standard warranty		
QUALIFICATION	DesignLight Consortium	DLC Standard	N/A	DLC Standard

Lighting layouts and spacing criteria available upon request

ORDERING:

ORDER CODE	MODELS	WATTS	LUMENS (lm)	EFFICACY (lm/W)	CCT	CASE QTY
9W 2FT T8 MODELS						
1409555	L9T8DE235-CG4	9W	1125	125 lm/W	3500K	25 pcs
1409556	L9T8DE240-CG4		1200	133 lm/W	4000K	
1409557	L9T8DE250-CG4		1250	139 lm/W	5000K	
12W 3FT T8 MODELS						
1409555	L12T8DE335-CG4	12W	1225	102 lm/W	3500K	25 pcs
1409556	L12T8DE340-CG4		1250	104 lm/W	4000K	
1409557	L12T8DE350-CG4		1300	108 lm/W	5000K	
11.5W 4FT T8 MODELS						
1409558	L11.5T8DE435-CG4	11.5W	1650	143 lm/W	3500K	25 pcs
1409559	L11.5T8DE440-CG4		1750	152 lm/W	4000K	
1409560	L11.5T8DE450-CG4		1800	156 lm/W	5000K	

RELAMPING EXAMPLE:

Double Ended Connection

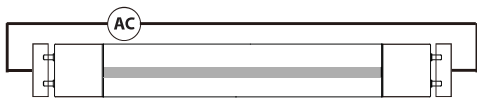
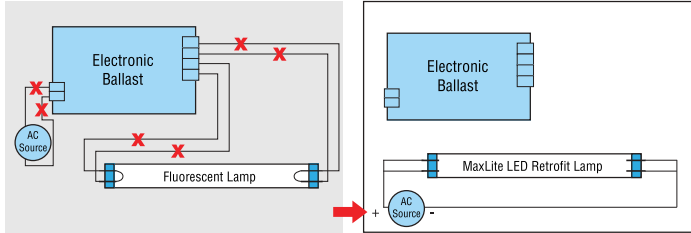

Figure 1. - Double-Ended connection

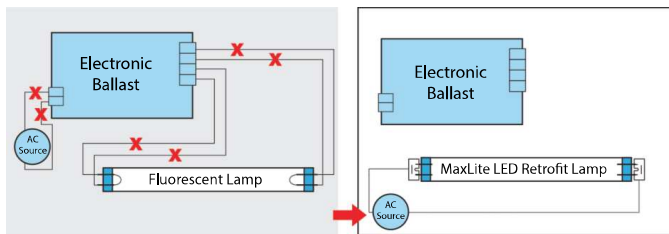

Figure 2. - Retrofit with One Lamp

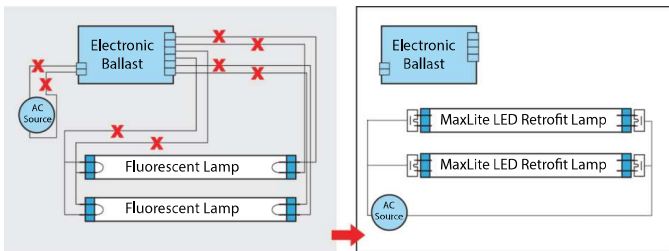

Figure 3. - Retrofit with Two Lamps

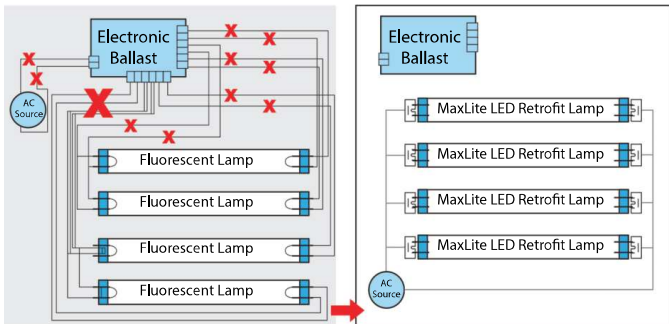

Figure 4. - Retrofit with Three/Four Lamps

Single Ended Connection

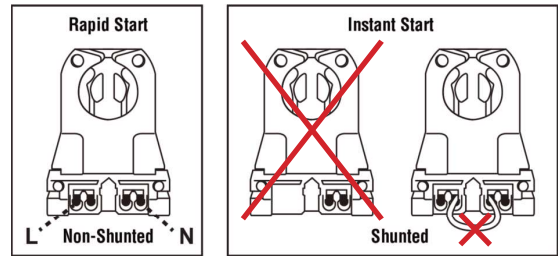

Figure 1. - Non-shunted & Shunted Lamp Holder



Figure 2. - Single sided connection

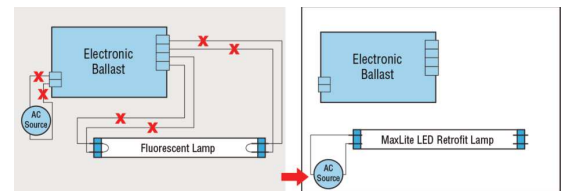

Figure 3. - Retrofit with One Lamp

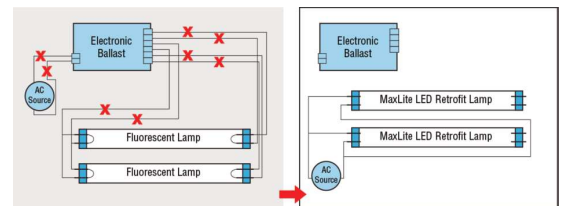

Figure 4. - Retrofit with Two Lamps

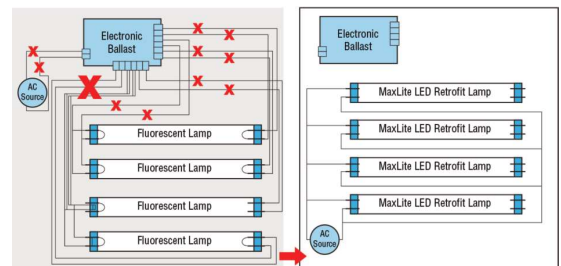

Figure 5. - Retrofit with Three/Four Lamps

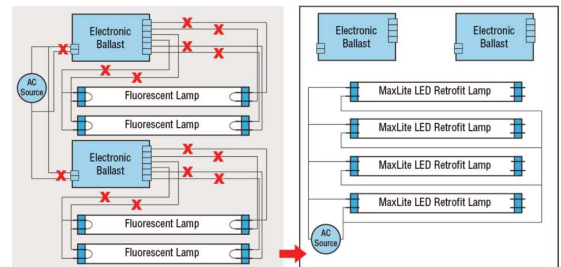

Figure 6. - Retrofit with Three/Four Lamps & Two Ballasts