

Driver LC 34W 690–825mA 0-10V fixC Ip SNC UNV

Linear essence series (US applications)

**Product description**

- _ Constant current LED driver
- _ Only for US applications
- _ Dimmable via 0 ... 10 V
- _ Dimming range 10 to 100 %
- _ Class 2
- _ FCC Part 15
- _ Meets UL 8750 SF3.1
- _ Meets DesignLights Consortium 4.3
- _ Temperature protection as per UL8750/UL Recognized
- _ Adjustable output current 690 or 825 mA
- _ Max. output power 34 W
- _ Nominal lifetime up to 50,000 h
- _ 5 years guarantee (conditions at <https://www.tridonic.com/manufacture-guarantee-conditions>)

Housing properties

- _ Casing: metal, white
- _ Type of protection IP20
- _ Dry and damp location

Functions

- _ Overload protection
- _ Short-circuit protection
- _ No-load protection
- _ Overtemperature protection

Website

<http://www.tridonic.com/87500862>

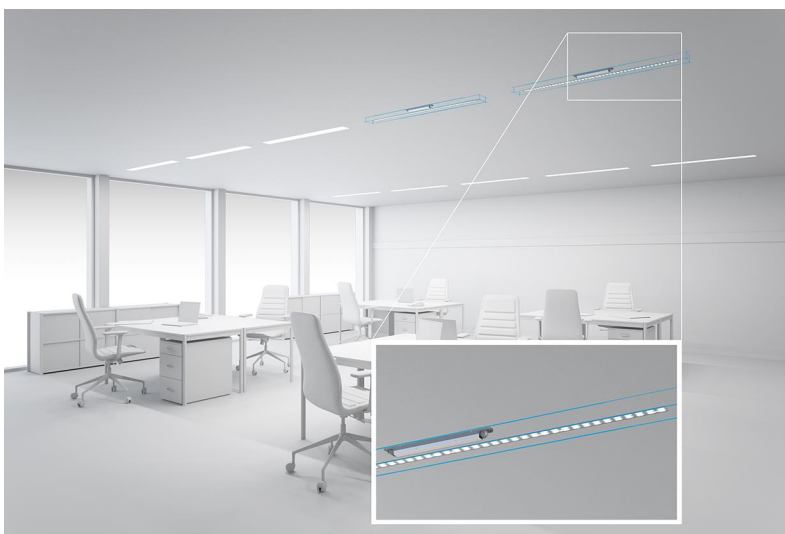

Spotlights



Downlights



Linear



Area



Floor | Wall



Free-standing



Street



Decorative



High bay

Driver LC 34W 690–825mA 0-10V fixC Ip SNC UNV

Linear essence series (US applications)

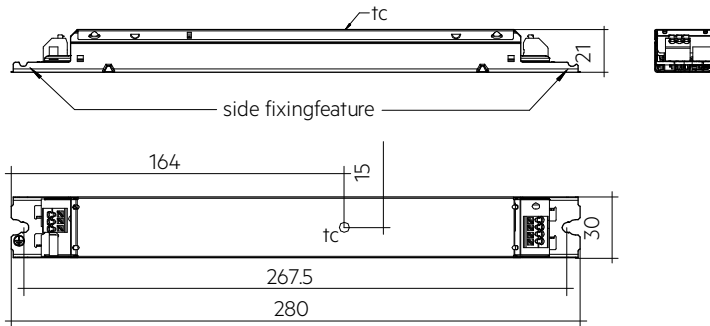

Dimensions in mm

Ordering data

| Type | Article number | Packaging, carton | Packaging, low volume | Packaging, high volume | Weight per pc. |
|--|----------------|-------------------|-----------------------|------------------------|----------------|
| LC 34/690-825/50 0-10V fixC Ip SNC UNV | 87500862 | 50 pc(s). | 900 pc(s). | 2,700 pc(s). | 0.176 kg |

Technical data

| | |
|---|------------------------------|
| Rated supply voltage | 120 – 277 V |
| AC voltage range | 108 – 305 V |
| Mains frequency | 50 / 60 Hz |
| Leakage current (at 120 V, 60 Hz, full load) ^{①②} | < 700 μ A |
| Leakage current (at 277 V, 60 Hz, full load) ^{①②} | < 700 μ A |
| Typ. efficiency (at 120 V, 60 Hz, full load) ^② | 84 % |
| Typ. efficiency (at 277 V, 60 Hz, full load) ^② | 87 % |
| λ (at 120 V, 60 Hz, full load) ^① | > 0.95C |
| λ (at 277 V, 60 Hz, full load) ^① | > 0.95C |
| Typ. input current in no-load operation (at 120 V, 60 Hz) | 15 mA |
| Typ. input current in no-load operation (at 277 V, 60 Hz) | 23 mA |
| Typ. input power in no-load operation (at 120 V, 60 Hz) | 0.31 W |
| Typ. input power in no-load operation (at 277 V, 60 Hz) | 0.41 W |
| In-rush current (peak / duration at 120 V) | 3.4 A / 28 μ s |
| In-rush current (peak / duration at 277 V) | 3.4 A / 21 μ s |
| THD (at 120 V, 60 Hz, full load) ^① | < 20 % |
| THD (at 277 V, 60 Hz, full load) ^① | < 20 % |
| Starttime (at 120V, 60 Hz, full load) ^① | \leq 500 ms |
| Starttime (at 277V, 60 Hz, full load) ^① | \leq 500 ms |
| Turn off time at full load | < 500 ms |
| Hold time (power failure, full load) | 0 s |
| Output current tolerance ^{①③} | \pm 5 % |
| Max. output current peak (non-repetitive) | \leq output current + 15 % |
| Output LF current ripple (< 120 Hz) | \pm 15 % |
| Max. output voltage (U-OUT) | 60 V |
| Dimming range | 10 – 100 % |
| Mains surge capability (between L - N) | 2 kV |
| Mains surge capability (between L/N - PE) | 2 kV |
| Surge voltage at output side (against PE) | 3.5 kV |
| Surge ring wave protection | 2.5 kV |
| Type of protection | IP20 |
| Lifetime | up to 50,000 h |
| Guarantee (conditions at www.tridonic.com) | 5 Year(s) |
| Dimensions L x W x H | 280 x 30 x 21 mm |

Approval marks

Standards

UL 8750, UL 1310, UL 840, CSA C22.2, FCC PART 15

Specific technical data

| Type | Output current ^① | Min. output voltage | Max. output voltage | Max. output power Cat 120 V, 60 Hz, full load | Typ. power consumption Cat 120 V, 60 Hz, full | Typ. current consumption Cat 120 V, 60 Hz, full | Typ. power consumption Cat 277 V, 60 Hz, full | Typ. current consumption Cat 277 V, 60 Hz, full | tc point ^③ max. | Ambient temperature ta | Iout select |
|--|-----------------------------|---------------------|---------------------|---|---|---|---|---|----------------------------|------------------------|-------------|
| LC 34/690-825/50 0-10V fixC Ip SNC UNV | 690 mA | 30 V | 49.5 V | 34.2 W | 41.2 W | 352 mA | 39.1 W | 14.3 mA | 75 °C | -20 ... +50 °C | 1 |
| LC 34/690-825/50 0-10V fixC Ip SNC UNV | 825 mA | 30 V | 41.2 V | 34.0 W | 40.0 W | 350 mA | 39.0 W | 16.0 mA | 75 °C | -20 ... +50 °C | ON |

① Valid at 100 % dimming level.

② Depending on the selected output current.

③ 5-year guarantee.

④ Output current is mean value.

1. Standards

UL 8750
 UL 1310
 UL 840
 CSA C22.2
 FCC Part 15, Class A

Product not designed for European Economic Area.

This device complies with Part 15 of the FCC Rules. Operation is subject to the following two conditions:

- (1) this device may not cause harmful interference, and
- (2) this device must accept any interference received, including interference that may cause undesired operation.

2. Thermal details and life-time

2.1 Expected life-time

Expected life-time 120 V

| Type | Output current | ta | 30 °C / 86 °F | 40 °C / 104 °F | 50 °C / 122 °F |
|--|----------------|-----------|----------------|----------------|----------------|
| LC 34/690-825/50 0-10V fixC Ip SNC UNV | 690 / 825 mA | tc | 55 °C / 131 °F | 65 °C / 149 °F | 75 °C / 167 °F |
| | | Life-time | > 100,000 h | 80,000 h | 40,000 h |

Expected life-time 277 V

| Type | Output current | ta | 30 °C / 86 °F | 40 °C / 104 °F | 50 °C / 122 °F |
|--|----------------|-----------|----------------|----------------|----------------|
| LC 34/690-825/50 0-10V fixC Ip SNC UNV | 690 / 825 mA | tc | 55 °C / 131 °F | 65 °C / 149 °F | 75 °C / 167 °F |
| | | Life-time | > 100,000 h | > 100,000 h | 60,000 h |

The LED driver is designed for a life-time stated above under reference conditions and with a failure probability of less than 10 %.

The relation of tc to ta temperature depends also on the luminaire design. If the measured tc temperature is approx. 5 K below tc max., ta temperature should be checked and eventually critical components (e.g. ELCAP) measured. Detailed information on request.

3. Installation / wiring

3.1 Circuit diagram

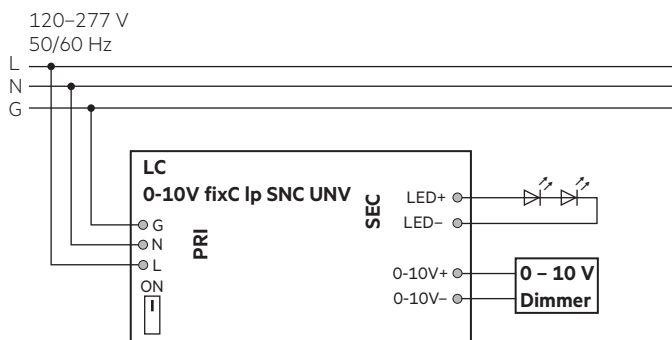

3.3 Loose wiring

Press down the "push button" and remove the cable from front.

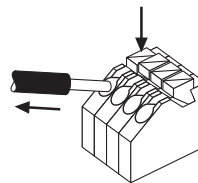

3.2 Wiring type and cross section

For wiring use stranded wire with ferrules or solid wire from 0.2 – 1.5 mm² (AWG24 – 16).

Strip 8.5–9.5 mm (3/8 inch) of insulation from the cables to ensure perfect operation of the push-wire terminals.

Use one wire for each terminal connector only.

LED module/LED driver/supply

wire preparation:
 0.2 – 1.5 mm² (AWG24 – 16)

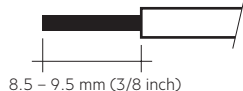

3.4 Wiring guidelines

- The cables should be run separately from the mains connections and mains cables to ensure good EMC conditions.
- The LED wiring should be kept as short as possible to ensure good EMC. The max. secondary cable length is 2 m / 6.56 ft (4 m / 13.12 ft circuit).
- Secondary switching is not permitted.
- The LED driver has no inverse-polarity protection on the secondary side. Wrong polarity can damage LED modules with no inverse-polarity protection.
- Wrong wiring of the LED driver can lead to malfunction or irreparable damage.
- To avoid the damage of the Driver, the wiring must be protected against short circuits to earth (sharp edged metal parts, metal cable clips, louver, etc.).

3.5 Hot plug-in

Hot plug-in is not supported due to residual output voltage of > 0 V. This can damage the LED load.

If a LED load is connected, the device has to be restarted before the output will be activated again.

This can be done via mains reset.

When used in conjunction with a self-contained emergency LED driver the emergency device must break the mains supply to the driver during the test mode/emergency mode (delayed mains supply of the LED driver at mains return) to prevent hot plug-in of the LED load.

3.6 Earth connection

The earth connection is conducted as protection earth (PE). If the LED Driver will be earthed, protection earth (PE) has to be used. There is no earth connection required for the functionality of the LED driver.

Earth connection is recommended to improve following behaviour:

- Electromagnetic interferences (EMI)
- Transmission of mains transients to the LED output

In general it is recommended to earth the LED driver if the LED module is mounted on earthed luminaire parts respectively heat sinks and thereby representing a high capacity against earth.

4. Electrical values

4.1 Efficiency vs load

120 V, 60 Hz:

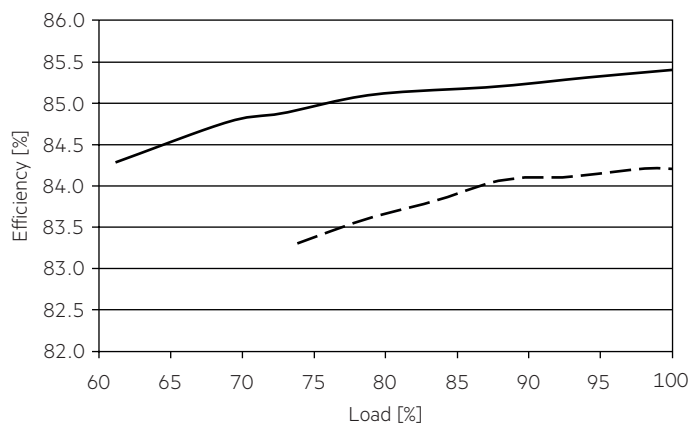

277 V, 60 Hz:

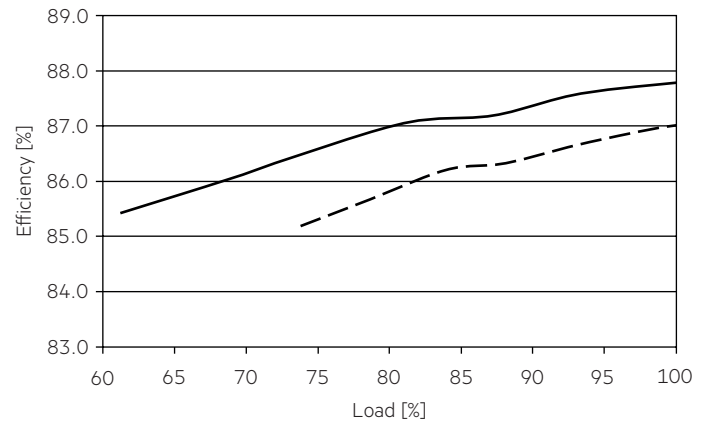

4.2 Power factor vs load

120 V, 60 Hz:

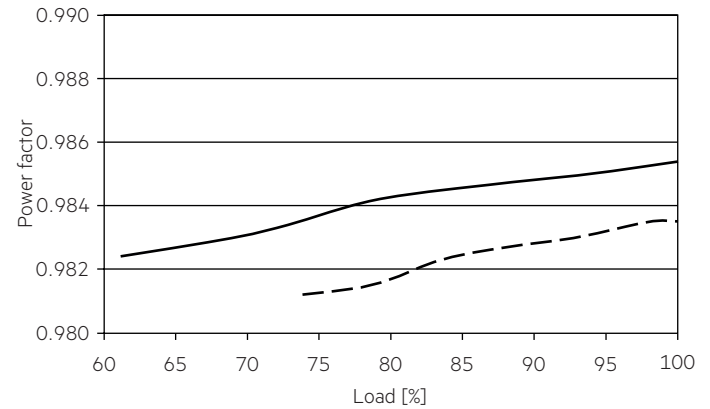

277 V, 60 Hz:

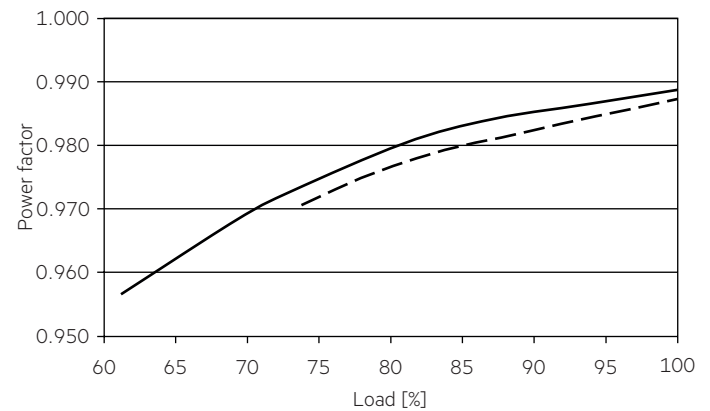

4.3 THD vs load (without harmonic < 5 mA or 0.6 % of the input current)

120 V, 60 Hz:

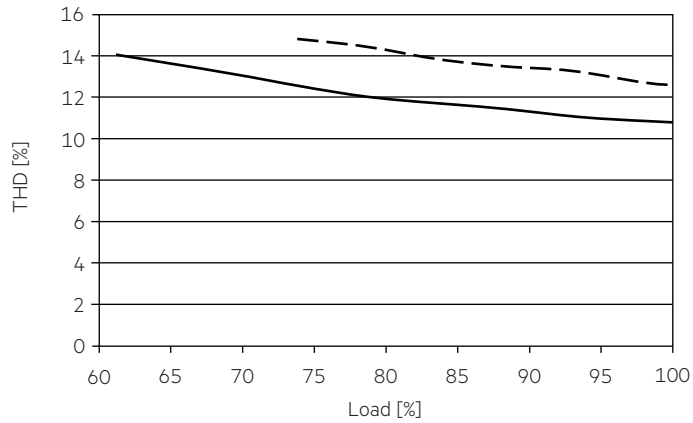

277 V, 60 Hz:

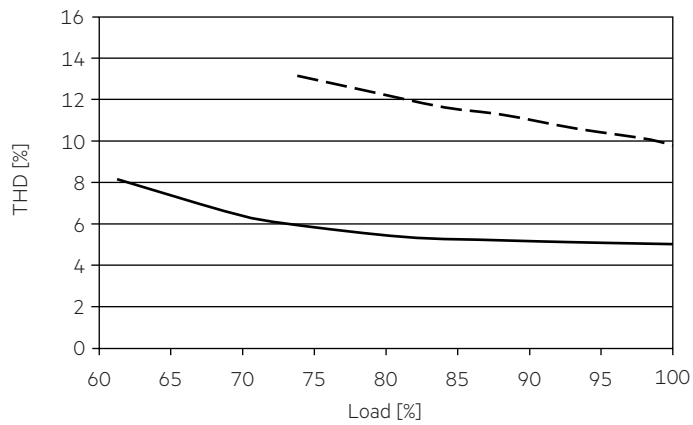

— 690 mA

- - - 825 mA

100 % load corresponds to the max. output power (full load) according to the table on page 2.

4.4 Maximum loading of automatic circuit breakers in relation to inrush current

120 V, 60 Hz:

| Automatic circuit breaker type | C10 | C13 | C16 | C20 | B10 | B13 | B16 | B20 | Inrush current | |
|---|--------------------------------|--------------------------------|--------------------------------|--------------------------------|--------------------------------|--------------------------------|--------------------------------|--------------------------------|----------------|-------|
| Installation Ø | 1.5 mm ² / AWG16 | 1.5 mm ² / AWG16 | 2.5 mm ² / AWG14 | 2.5 mm ² / AWG14 | 1.5 mm ² / AWG16 | 1.5 mm ² / AWG16 | 2.5 mm ² / AWG14 | 2.5 mm ² / AWG14 | I_{max} | time |
| LC 34/690-825/50 0-10V fixC Ip SNC UNV | 35 | 26 | 21 | 17 | 35 | 26 | 21 | 17 | 3.4 A | 28 µs |

277 V, 60 Hz:

| Automatic circuit breaker type | C10 | C13 | C16 | C20 | B10 | B13 | B16 | B20 | Inrush current | |
|---|--------------------------------|--------------------------------|--------------------------------|--------------------------------|--------------------------------|--------------------------------|--------------------------------|--------------------------------|----------------|-------|
| Installation Ø | 1.5 mm ² / AWG16 | 1.5 mm ² / AWG16 | 2.5 mm ² / AWG14 | 2.5 mm ² / AWG14 | 1.5 mm ² / AWG16 | 1.5 mm ² / AWG16 | 2.5 mm ² / AWG14 | 2.5 mm ² / AWG14 | I_{max} | time |
| LC 34/690-825/50 0-10V fixC Ip SNC UNV | 14 | 11 | 8 | 7 | 14 | 11 | 8 | 7 | 3.4 A | 21 µs |

These are max. values calculated out of continuous current running the device on full load.

There is no limitation due to inrush current.

If load is smaller than full load for calculation only continuous current has to be considered.

4.5 Dimming

Dimming range is 10 to 100%.

4.6 Dimming characteristics

Control input (0 – 10 V)

| | |
|-------------------------------|---------------------------------|
| Control input open | max. dimming level |
| Control input short-circuited | min. dimming level |
| Interface current range | 120 µA ± 3 % |
| Max. permitted input voltage | ± 16 V |
| Voltage range dimming | 0 – 10 V ^① |
| Input voltage < 1 V | min. dimming level ^① |
| Input voltage > 8.5 V | max. dimming level ^① |

Interface supports current sink dimmers.

Interface is class 2.

^① See graph below (at full load):

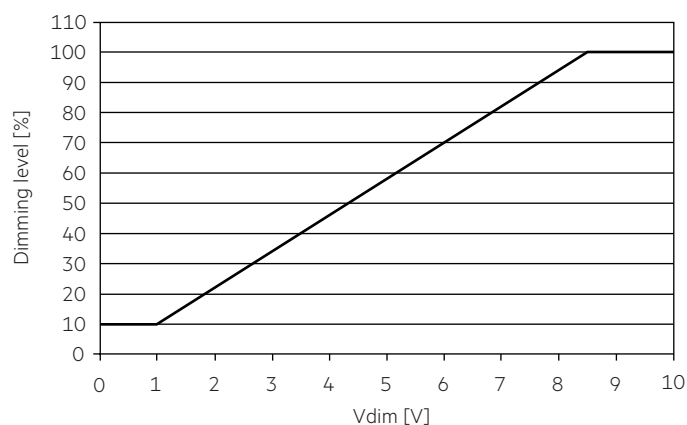

4.7 Insulation between terminals

| Insulation | Mains | -LED / +LED | 0-10V | Protective earth (housing) |
|----------------------------|--------|-------------|--------|----------------------------|
| Mains | - | double | double | basic |
| -LED / +LED | double | - | basic | basic |
| 0-10V | double | basic | - | basic |
| Protective earth (housing) | basic | basic | basic | - |

basic ... represents basic insulation.

double ... represents double or reinforced insulation.

5. Protective features

5.1 Short-circuit behaviour

In case of a short-circuit at the LED output the LED output is switched off. After elimination of the short-circuit fault LED driver will recover automatically.

5.2 No-load operation

The LED driver works in burst working mode to provide a constant output voltage regulation which allows the application to be able to work safely when LED string opens due to a failure.

5.3 Overload protection

If the maximum load is exceeded by a defined internal limit, the LED driver will protect itself and LED may flicker. After elimination of the overload the nominal operation will recover automatically.

5.4 Overtemperature protection

The LED driver is protected against temporary thermal overheating. If the temperature limit is exceeded the LED driver will switch off. It restarts automatically. The temperature protection is activated typically 10 °C above $t_{c\ max}$.

6. Miscellaneous

6.1 Insulation and electric strength testing of luminaires

Electronic devices can be damaged by high voltage. This has to be considered during the routine testing of the luminaires in production.

According to UL 8750 (informative only!) each luminaire should be submitted to an insulation test with 500V_{DC}. The dielectric withstand test equipment shall employ a transformer of 500-VA or larger capacity and have a variable output voltage that is essentially sinusoidal or continuous direct current. The applied potential is to be increased from zero at a substantially uniform rate until the required test level is reached, and is to be held at that level for 1 minute.

As an alternative, UL8750 (informative only!) describes a test of the electrical strength with 2V AC + 1000V (or 1.414 x V DC). To avoid damage to the electronic devices this test must not be conducted.

6.2 Conditions of use and storage

Humidity: 5% up to max. 85%,
not condensed
(max. 56 days/year at 85%)

Storage temperature: -40 °C up to max. +80 °C

The devices have to be acclimatised to the specified temperature range (t_a) before they can be operated.

The LED driver is declared as inbuilt LED controlgear, meaning it is intended to be used within a luminaire enclosure.

If the product is used outside a luminaire, the installation must provide suitable protection for people and environment (e.g. in illuminated ceilings).

6.3 Maximum number of switching cycles

All LED driver are tested with 50,000 switching cycles.

6.4 Additional information

Additional technical information at www.tridonic.com → Technical Data

Life-time declarations are informative and represent no warranty claim. No warranty if device was opened.