

PROJECT \_\_\_\_\_

TYPE \_\_\_\_\_

SPECIFICATION \_\_\_\_\_

### MAIN FEATURES

- 95 CRI Standard
- Versatile linear luminaire designed to easily adapt into your current track layout with a variety of optics
- Effective heat emission for thermal management
- Integrated driver meets IEEE 1789-2015 Low Risk flicker category across dimming range
- Custom optic platform to ensure excellent light control

### CONSTRUCTION + FINISH

- Weight: 2 ft.: 1.5 lbs.; 4ft: 2.5 lbs.
- Rigid aluminum extruded body
- Standard finishes:
  - White: RAL 9003
  - Black: RAL 9005
  - Silver: RAL 7001

### OPTICS + PERFORMANCE

- 4 custom beam spreads available
  - Lambertian
  - Narrow
  - Asymmetric
  - Bat-wing
- 2 ft.: 2300 or 1700 lumens at 19W or 1200 lumens at 13W
- 4 ft.: 4600 or 3600 lumens at 40W or 2600 lumens at 27W
- 6 ft.: 6800 or 5100 lumens at 60W or 3600 lumens at 40W
- Color Temperatures
  - 95 CRI: 2700K, 3000K, 3500K, 4000K, 5000K
- Fixture life: 50,000 hours

### ELECTRICAL + CONTROLS

- 120V with phase-cut TRIAC and ELV dimming to 1%

### MOUNTING

- J-type and H-type Track; 120V, 1-circuit/1-neutral

### RATINGS + CERTIFICATIONS

- IP20 and IK08 rated
- UL Listed for dry location (E487826)
- RoHS-compliant
- BAA compliant
- Designed and assembled in U.S.A.

### WARRANTY

- 5-year warranty

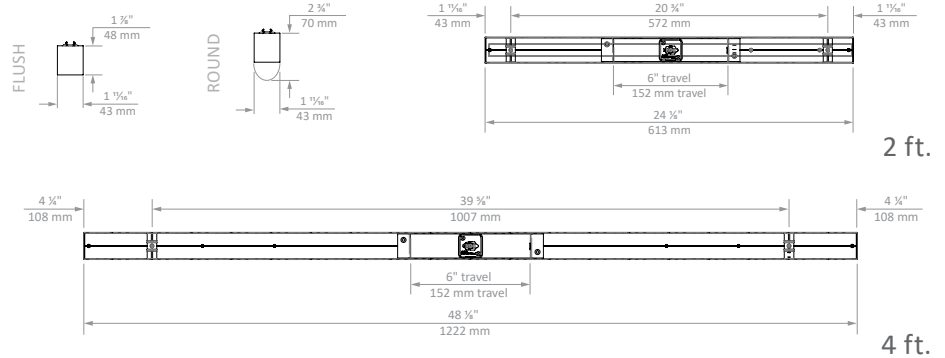
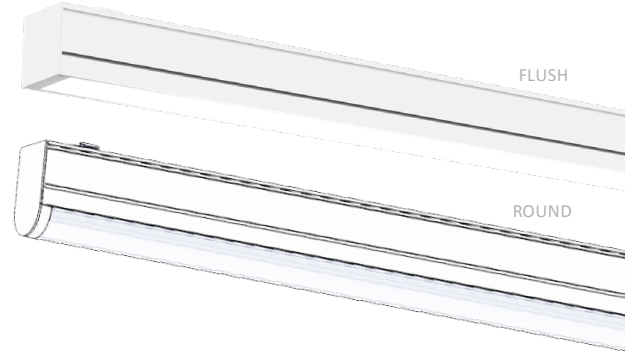

### Ordering Information

Example: LCL/4F/1/DFL/930/3600/PW/J

Fixture	Optic	CRI	CCT	Finish	Track Type
LCL	DFL - Diffuse Flush Lambertian DFN - Diffuse Flush Narrow DFA - Diffuse Flush Asymmetric DFB - Diffuse Flush Bat-wing DRL - Diffuse Round Lambertian	9 - 95+	27 - 2700K 30 - 3000K 35 - 3500K 40 - 4000K 50 - 5000K	PW - Perfect White BK - Black SV* - Silver	J H
Voltage: 1 - 120V; 1% phase-cut dimming					
Length			Output		
2F - 2 feet			2300 (19W) 1700 (19W) 1200 (13W)		
4F - 4 feet			4600 (40W) 3600 (40W) 2600 (27W)		
6F - 6 feet			6800 (60W) 5100 (60W) 3600 (40W)		



\*Consult factory for lead time and availability

## Lucie Linear

2 FT + 4 FT + 6 FT | TRACK MOUNT  
LED TRACK MOUNT LINEARS

### OPTIC DISTRIBUTIONS

LAMBERTIAN

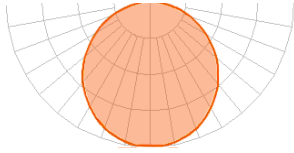

NARROW

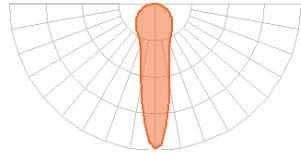

ASYMMETRIC

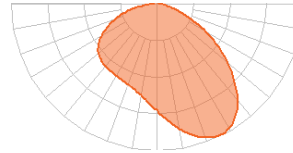

BAT-WING

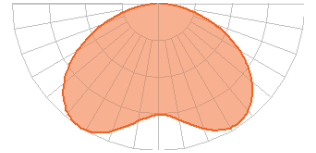

### TM30 COLOR REPORTS

- 3000K with 95 CRI
- $R_A = 95$ ;  $R_g = 62$
- $R_f = 92$ ;  $R_g = 101$

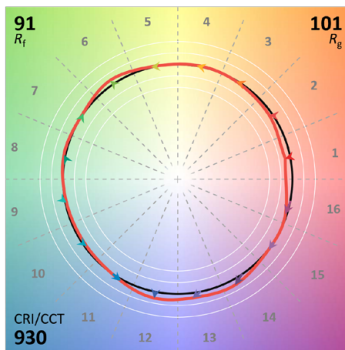

**WARNING:** Not for use in fully enclosed luminaires. Risk of electric shock. Use in an indoor, dry location only. This device is not intended for use with emergency exit fixtures or emergency exit lights. May not be compatible with all dimmers; please visit [solais.com/dimming](http://solais.com/dimming) for up-to-date dimmer compatibility information.

**NOTES:** This device complies with Part 15 of the FCC Rule. This product may cause interference with other devices. If interference occurs, change the locations of the products involved. **Compatible on 120v systems.**

