

Hi-lume 1% EcoSystem LED Driver with Soft-on, Fade-to-Black

Hi-lume 1% EcoSystem LED Drivers with Soft-on, Fade-to-Black provide a high-performance solution for any space, in any application. They provide smooth, continuous dimming down to 1% of full output current, and fade smoothly between 0% and 1% with Soft-on, Fade-to-Black.

Features

- UL Listed Class P.
- UL Type TL rated. Visit “Online Certificates Directory” at www.ul.com, enter file number “E322469” to determine the Type TL numbers specific to the LDEx model Lutron LED Driver.
- Soft-on, Fade-to-Black: fades smoothly between 0% and 1% when turned on and off for an incandescent-like experience.
- Continuous, flicker-free dimming from 100% to 1%¹.
- Dimming Method:
 - Constant-current reduction dimming provides video-friendly performance down to 5%
 - PWM dimming below 5% (240 Hz), % Modulation = 100%
- Guaranteed dimming performance when used with Lutron EcoSystem controls.
- Guaranteed compatibility with Energi Savr Node units with EcoSystem, GRAFIK Eye QS with EcoSystem, PowPak dimming module with EcoSystem, and Quantum systems, allowing for integration into a planned or existing EcoSystem lighting control solution.
- QwikFig compatible models available, see **How to Build a Model Number** page for details. For more information, please refer to the QwikFig User Guide (Lutron P/N 041473) or contact your Lutron sales representative.
- Protected from miswires of input power to EcoSystem control inputs up to 277 V \sim .
- Rated lifetime of 50,000 hours at 75 °C (167 °F) calibration point (t_{90}).
- FCC Part 15 Class A
- 100% performance tested at factory before shipping.
- RoHS compliant.

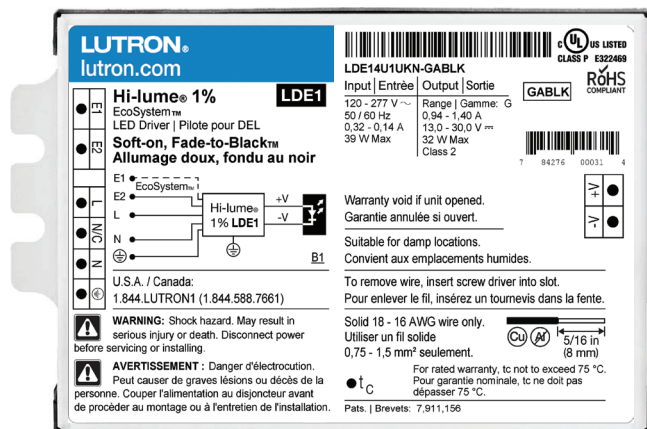

Case type K

3.00 in (76 mm) W × 1.00 in (25 mm) H × 4.90 in (124 mm) L



Case type M

1.18 in (30 mm) W × 1.00 in (25 mm) H × 14.13 in (359 mm) L

- Non-volatile memory restores all settings after power failure.
- For more information please visit: www.lutron.com/hilume1softbled

EcoSystem Features

- Simpler to wire and more reliable than 0–10 V \sim .
- Guarantees compatibility between Lutron controls, LED drivers, ballasts, and sensors.
- Accommodates zone and control changes without rewiring.
- Link to Lutron Quantum Total Light Management System to monitor lighting power consumption.
- Polarity-free and topology-free.
- Digital EcoSystem intelligence allows easy code compliance.
- Digital EcoSystem control link can be Class 1 or Class 2.

¹ Light output at 1% depends on the efficacy of the LED light engine used with the driver.

Job Name:

Model Numbers:

Job Number:

Specifications

Regulatory Approvals and Compliance

- UL Listed Class P
- Lutron Quality Systems registered to ISO 9001.2008
- Manufacturing facilities employ ESD reduction practices that comply with the requirements of ANSI/ESD S20.20
- Meets ANSI C62.41 category A surge protection standards up to and including 4 kV
- Inrush current less than NEMA 410-2011 limit
- FCC Part 15 Class A
- Canadian EMI Class A Compliance Equivalent: CAN ICES-005(A)/NMB-005(A).
- Meets UL® 8750, “Light Emitting Diode (LED) Equipment For Use in Lighting Products”
- Class 2 output
- LED drivers need to meet certain performance criteria in order for the completed luminaires to comply with the ENERGY STAR® Luminaires V2.0 Specification. All models meet these performance criteria throughout their entire load compatibility regions. Consult Application Note #599, “ENERGY STAR® Luminaires V2.0 and Lutron Drivers,” for availability dates of compliant products.
- LED drivers need to meet certain performance criteria in order for the completed luminaires to comply with Title 24 requirements as detailed in CEC-400-2015-037-CMF. All models meet both commercial (at 120 V~/277 V~) and residential (at 120 V~) performance criteria throughout their entire load operating regions. Consult CEC-400-2015-032-CMF Section 6.2.7 for important information on meeting start-up time requirements with fade-in lighting.
- M-case type performance is in compliance with DLC version 2.1 in designated areas (see “Load Compatibility” graph in **Output Range** pages).

Performance

- Soft-on, Fade-to-Black: fades smoothly between 0% and 1% when turned on and off for an incandescent-like experience
- Dimming Range: 100% to 1%¹
- Operating Voltage: 120 V~ to 277 V~ at 50/60 Hz
- Lifetime: 50,000 hours when calibration point (t_c) at 75 °C (167 °F)²
- For rated warranty, t_c not to exceed 75 °C (167 °F) (maximum rated temperature)²
- Patented thermal foldback protection

- At turn on, lighting fades smoothly to the desired level without decreasing or flashing to full brightness
- Non-volatile memory restores all driver settings after power failure
- Typical standby power consumption: 0.2 W at 120 V~ and 0.3 W at 277 V~
- Open-circuit protected output
- Short-circuit and overload-protected output
- Class 2 output designed to withstand hot swap of the LED load.

Environmental

- Sound rated: Class A inaudible in 24 dBA ambient
- Relative Humidity: maximum 90% non-condensing
- Minimum Operating Ambient Temperature: $t_a = 0$ °C (32 °F)³
- Indoor use only
- Rated for dry and damp locations

Driver Wiring and Mounting

- Driver is grounded by a mounting screw to the grounded fixture or by terminal connection
- Terminal blocks on the driver accept one solid wire per terminal from 18 to 16 AWG (0.75 to 1.5 mm²)
- Fixture must be grounded in accordance with local and national electrical codes
- Maximum driver-to-LED light engine wire length for:

Wire Gauge	Maximum Lead Length		
	150 mA to 700 mA	710 mA to 1.50 A	1.51 A to 2.10 A
18 AWG (0.75 mm ²)	30 ft (9 m)	15 ft (4.5 m)	10 ft (3 m)
16 AWG (1.5 mm ²)	35 ft (10.5 m)	25 ft (7.5 m)	15 ft (4.5 m)
14 AWG (2.5 mm ²) ⁴	50 ft (15 m)	40 ft (12 m)	25 ft (7.5 m)
12 AWG (4.0 mm ²) ⁴	100 ft (30 m)	60 ft (18 m)	40 ft (12 m)

¹ Light output at 1% depends on the efficacy of the LED light engine used with the driver.

² To maintain warranty, installer is responsible for ensuring that the driver calibration point does not exceed 75 °C (167 °F).

³ Where t_a is the temperature of the air directly surrounding the driver.

⁴ Terminal blocks on the drivers accept only solid 18 to 16 AWG (0.75 mm² to 1.5 mm²) wire. To use wire gauges larger than the terminal blocks' rated gauge of 16 AWG (1.5 mm²) refer to the **Terminal Wiring Gauges** diagram. Connect up to 3 ft (1.0 m) of 18 to 16 AWG (0.75 mm² to 1.5 mm²) wire to the LED driver terminal blocks, then connect 12 or 14 AWG (4.0 mm² or 2.5 mm²) up to the length allowed in the above table.

ENERGY STAR is a registered trademark of the U.S. Environmental Protection Agency

Job Name:

Model Numbers:

Job Number:

How to Select the Correct LED Driver for Your Load

1. Review the specifications of the LED load.
2. Identify the minimum and maximum operating voltage of the LED load at the desired operating current. This “current” will be the rated output current of the LED driver. Consult the LED load manufacturer for any questions.

Example: An LED load that is rated at 1 A and 33 V nominally, has an output voltage range of 28–38 V (at 1 A) due to unit-to-unit variation, temperature, etc.

3. Determine the proper operating range of the LED driver.
 - a. Identify the output range(s) of the driver family that includes the desired current.

- i. Select Current

Example: Only “B”, “C”, “U”, and “V” models meet the current range of the selected load (1 A).

LED Load Output Range

L = 0.15 – 0.32 A, 20–40 V_{DC}, 5-10 W

M = 0.25 – 0.50 A, 20–40 V_{DC}, 6.5-14 W

N = 0.35 – 0.75 A, 20–40 V_{DC}, 10-20 W

B = 0.50 – 1.25 A, 20–40 V_{DC}, 15-35 W

C = 0.88 – 1.75 A, 20–40 V_{DC}, 25-50 W

D = 1.25 – 2.10 A, 20–40 V_{DC}, 35-75 W

J = 0.15 – 0.30 A, 30–50 V_{DC}, 6-12 W

K = 0.24 – 0.50 A, 30–50 V_{DC}, 9-20 W

T = 0.40 – 0.83 A, 30–50 V_{DC}, 15-35 W

U = 0.70 – 1.33 A, 30–50 V_{DC}, 25-50 W

V = 1.00 – 1.88 A, 30–50 V_{DC}, 40-75 W

- ii. Select Voltage

Example: Out of the 4 models indicated above, only “B” and “C” models meet the voltage requirement for the selected load (28–38 V).

LED Load Output Range

L = 0.15 – 0.32 A, 20–40 V_{DC}, 5-10 W

M = 0.25 – 0.50 A, 20–40 V_{DC}, 6.5-14 W

N = 0.35 – 0.75 A, 20–40 V_{DC}, 10-20 W

B = 0.50 – 1.25 A, 20–40 V_{DC}, 15-35 W

C = 0.88 – 1.75 A, 20–40 V_{DC}, 25-50 W

D = 1.25 – 2.10 A, 20–40 V_{DC}, 35-75 W

J = 0.15 – 0.30 A, 30–50 V_{DC}, 6-12 W

K = 0.24 – 0.50 A, 30–50 V_{DC}, 9-20 W

T = 0.40 – 0.83 A, 30–50 V_{DC}, 15-35 W

U = 0.70 – 1.33 A, 30–50 V_{DC}, 25-50 W

V = 1.00 – 1.88 A, 30–50 V_{DC}, 40-75 W

continued on next page...

Job Name:

Model Numbers:

Job Number:

How to Select the Correct LED Driver for Your Load (continued)

b. Examine the **Load Compatibility** graphs below for each output range to ensure that the voltage range of the LED load is within the safe operating area.

iii. Select Power

Example: Lines marked below indicate load specifications (28–38 V at 1 A).

“B” Model (Not Compatible) ❌

Since the maximum voltage of the load (38 V) exceeds the allowable voltage of “B” model (35 V at 1 A), this model is not compatible.

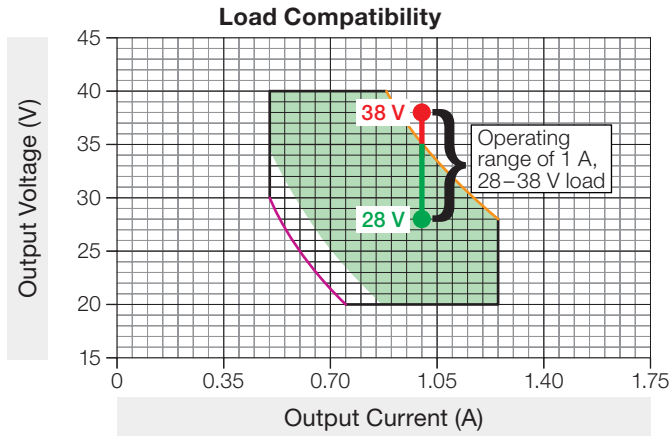

Key: Shaded area meets DLC Version 2.1 (areas outside of shaded areas may not meet THD or PF requirements).
 Constant 15 W output Constant 35 W output

“C” Model (Compatible) ✅

Operating voltage range for “C” model is 25–40 V at 1 A. Since the load specifications are within the operating range, “C” model is compatible for this load.

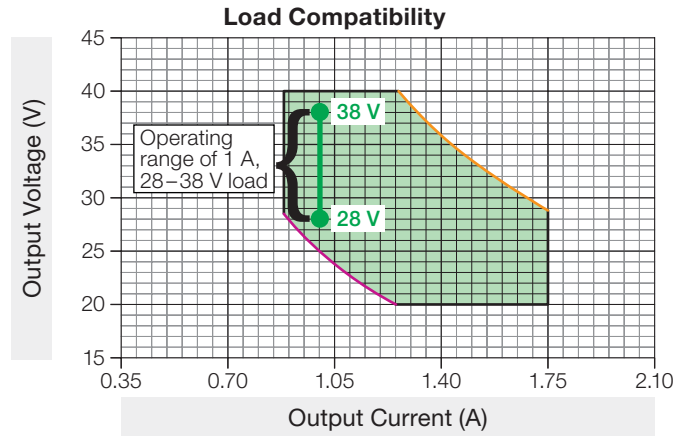

Key: Shaded area meets DLC Version 2.1 (areas outside of shaded areas may not meet THD or PF requirements).
 Constant 25 W output Constant 50 W output

4. See **How to Build A Model Number** to create the appropriate model number for the desired driver. If a QwikFig compatible driver is needed, identify the proper **LED Load Output Range** (voltage and current) and insert “BLK” in the **Current Level (for Constant Current)** section of the model number.

Job Name:	Model Numbers:
Job Number:	

How to Build a Model Number, M-Case Type (“BLK” models for use with Lutron QwikFig technology): Hi-lume 1% EcoSystem (up to 75 W) LED Driver with Soft-on, Fade-to-Black

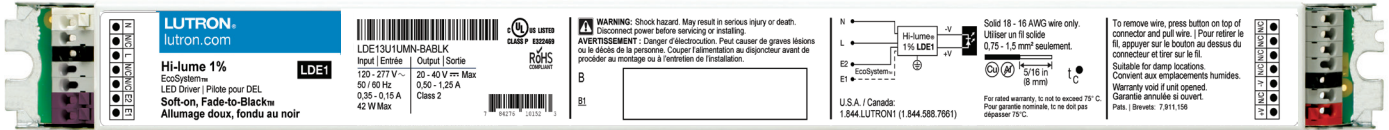

M-case type

L D E 1 U 1 U M N - A

LED Load Power Range

(Power Range number is based on Load Output Range category)

- **1:** select if LED Load Output Range is “J,” “L,” or “M”
- **2:** select if LED Load Output Range is “K” or “N”
- **3:** select if LED Load Output Range is “B” or “T”
- **5:** select if LED Load Output Range is “C” or “U”
- **7:** select if LED Load Output Range is “D” or “V”

LED Load Output Range: Class 2 Constant Current

(see the following pages for more detail)

- **L:** 0.15–0.32 A, 20.0–40.0 V⁻⁻⁻, 5–10 W
- **M:** 0.25–0.50 A, 20.0–40.0 V⁻⁻⁻, 6.5–14 W
- **N:** 0.35–0.75 A, 20.0–40.0 V⁻⁻⁻, 10–20 W
- **B:** 0.50–1.25 A, 20.0–40.0 V⁻⁻⁻, 15–35 W
- **C:** 0.88–1.75 A, 20.0–40.0 V⁻⁻⁻, 25–50 W
- **D:** 1.25–2.10 A, 20.0–40.0 V⁻⁻⁻, 35–75 W
- **J:** 0.15–0.30 A, 30.0–50.0 V⁻⁻⁻, 6–12 W
- **K:** 0.24–0.50 A, 30.0–50.0 V⁻⁻⁻, 9–20 W
- **T:** 0.40–0.83 A, 30.0–50.0 V⁻⁻⁻, 15–35 W
- **U:** 0.70–1.33 A, 30.0–50.0 V⁻⁻⁻, 25–50 W
- **V:** 1.00–1.88 A, 30.0–50.0 V⁻⁻⁻, 40–75 W

Current Level (for Constant-Current)

- **015** = 0.15 A
- **210** = 2.10 A

Option 1: Order a driver configured by Lutron to a desired output current.

Example: LDE13U1UMN-BA070 has been pre-configured at Lutron to an output of 0.70 A. Refer to the example above.

Note: Lutron pre-configured drivers are *not* QwikFig compatible and cannot be re-configured.

Option 2: Order a QwikFig compatible driver.

Example: LDE13U1UMN-BABLK (0.5–1.25 A)*

Note: Default set to minimum output current for the respective **LED Load Output Range**.

Example: LDE13U1UMN-BA070

- 0.70 A
- 15–28 W^{**}
- 21.5–40.0 V⁻⁻⁻† LED driver

For further assistance in selecting your model number, contact our LED Center of Excellence at **LEDs@lutron.com**

^{**} At 0.7 A, maximum voltage of 40 V provides 28 W (0.7 A × 40.0 V = 28 W)

[†] Minimum voltage of LDE13U1UMN-BA070 limited by 15 W minimum power: 15 W ÷ 0.70 A = 21.5 V

Attention: Model numbers may appear similar to Lutron Hi-lume 1% EcoSystem, Hi-lume 1% 3-wire or Hi-lume 1% 2-wire drivers, but they are not direct model-for-model replacements. Please note the driver's output rating and the load ratings to select the correct product for your fixture.

* Output voltage range changes with output current and according to power limits. Check driver specifications on the following pages carefully to understand output voltage range of a particular SKU. Purchaser is responsible for electrical compatibility between LED driver and LED load.

LUTRON SPECIFICATION SUBMITTAL

Page

Job Name:	Model Numbers:
Job Number:	

M-Case Models: "L" Output Range

Driver Type	Output Voltage	Output Current	Output Power	Standards Recognition	Maximum Rated Temp. @ t _c for Warranty
Constant Current Driver (Class 2)	20–40 V \sim	0.15–0.32 A*	5–10 W	 US LISTED CLASS P E322469	75 °C

* QwikFig compatible model number LDE11U1UMN-LABLK is configurable to any current within this range in 0.01 A increments.

Typical Performance Specifications:

Parameter	Value	Test Conditions
Input Current	0.05 A	V _i = 277 V \sim , t _a = 25 °C, I _o = 0.25 A, V _o = 40 V \sim , Maximum Light Output LDE11U1UMN-LA025
Power Factor	0.93	
THD	18%	
Driver Efficiency	78%	

Load Compatibility

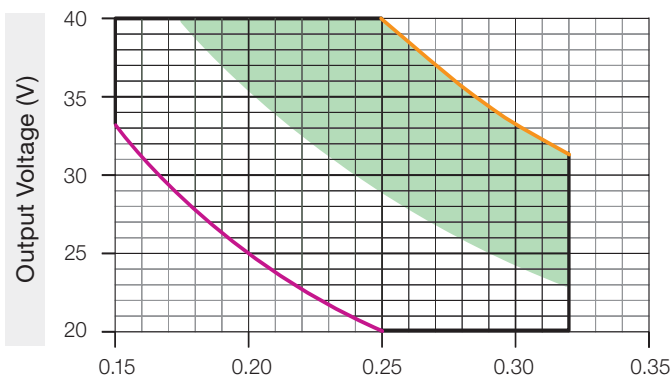

Key:
■ Shaded area meets DLC Version 2.1 (areas outside of shaded areas may not meet THD or PF requirements).
— Constant 5 W output — Constant 10 W output

Typical Efficiency vs Output Current

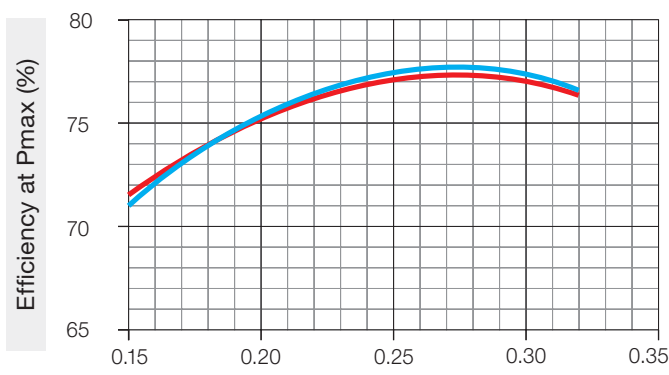

Key: — 120 V \sim — 277 V \sim

Typical THD vs. Output Power

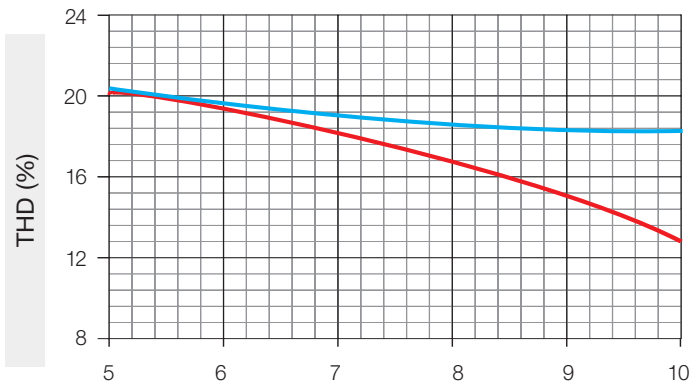

Key: — 120 V \sim — 277 V \sim

Typical Power Factor vs. Output Power

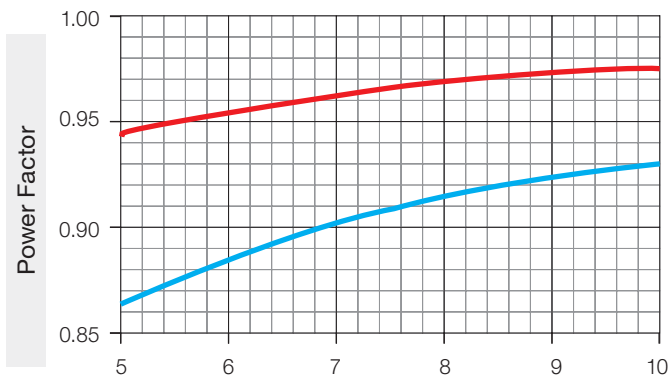

Key: — 120 V \sim — 277 V \sim

Job Name:	Model Numbers:
Job Number:	

M-Case Models: "M" Output Range

Driver Type	Output Voltage	Output Current	Output Power	Standards Recognition	Maximum Rated Temp. @ t _c for Warranty
Constant Current Driver (Class 2)	20–40 V ⁼⁼	0.25–0.50 A*	6.5–14 W	US LISTED CLASS P E322469	75 °C

* QwikFig compatible model number LDE11U1UMN-MABLK is configurable to any current within this range in 0.01 A increments.

Typical Performance Specifications:

Parameter	Value	Test Conditions
Input Current	0.07 A	V _i = 277 V [~] , t _a = 25 °C, I _o = 0.35 A, V _o = 40 V ⁼⁼ , Maximum Light Output LDE11U1UMN-MA035
Power Factor	0.95	
THD	20%	
Driver Efficiency	80%	

Load Compatibility

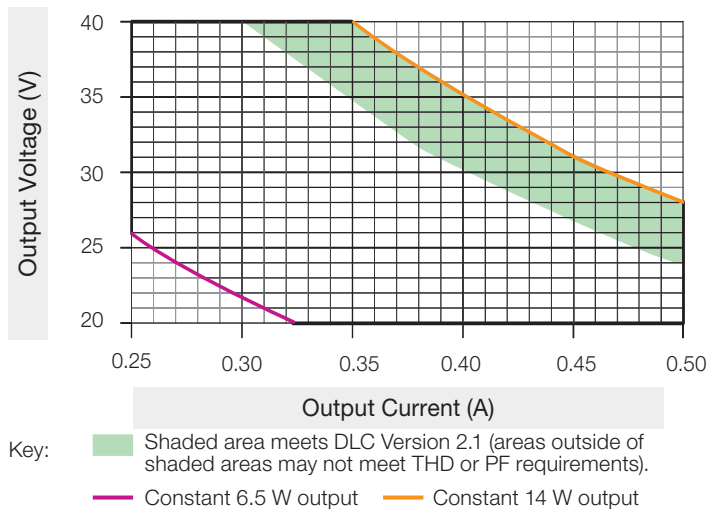

Typical Efficiency vs Output Current

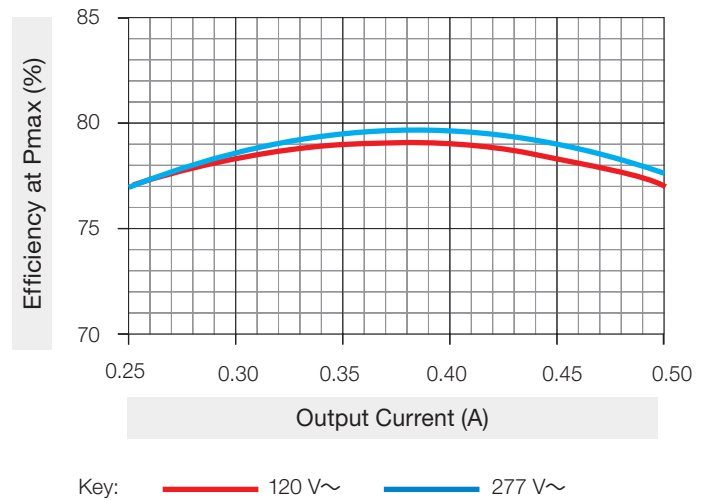

Typical THD vs. Output Power

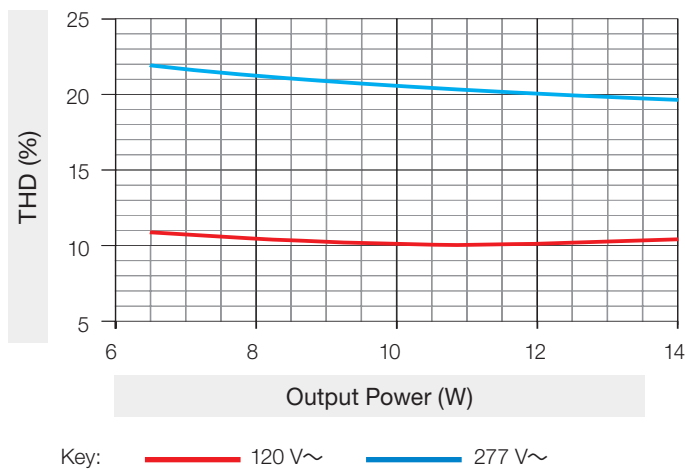

Typical Power Factor vs. Output Power

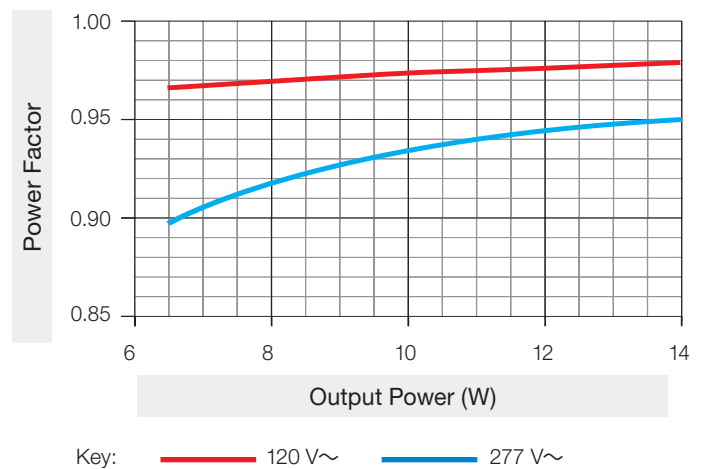

Job Name:	Model Numbers:
Job Number:	

M-Case Models: "N" Output Range

Driver Type	Output Voltage	Output Current	Output Power	Standards Recognition	Maximum Rated Temp. @ t _c for Warranty
Constant Current Driver (Class 2)	20–40 V ⁻⁻⁻	0.35–0.75 A*	10–20 W	US LISTED CLASS P E322469	75 °C

* QwikFig compatible model number LDE12U1UMN-NABLK is configurable to any current within this range in 0.01 A increments.

Typical Performance Specifications:

Parameter	Value	Test Conditions
Input Current	0.09 A	V _i = 277 V [~] , t _a = 25 °C, I _o = 0.50 A, V _o = 40 V ⁻⁻⁻ , Maximum Light Output LDE12U1UMN-NA050
Power Factor	0.97	
THD	16%	
Driver Efficiency	83%	

Load Compatibility

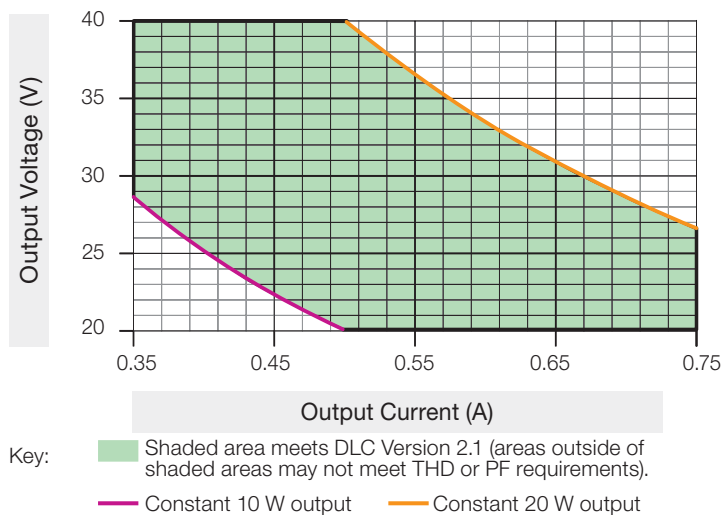

Typical Efficiency vs Output Current

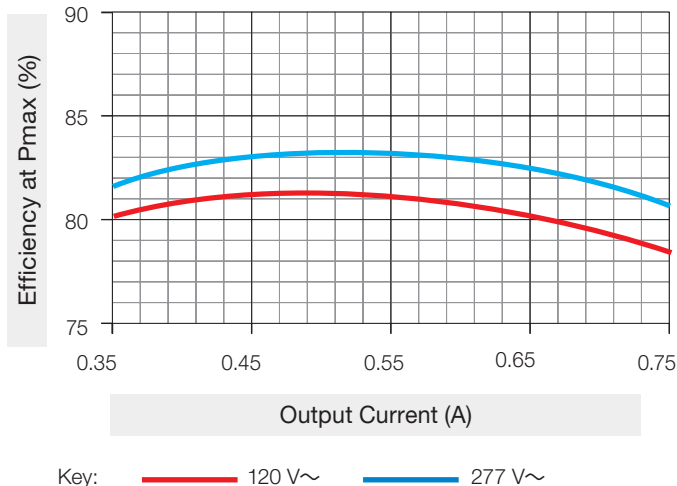

Typical THD vs. Output Power

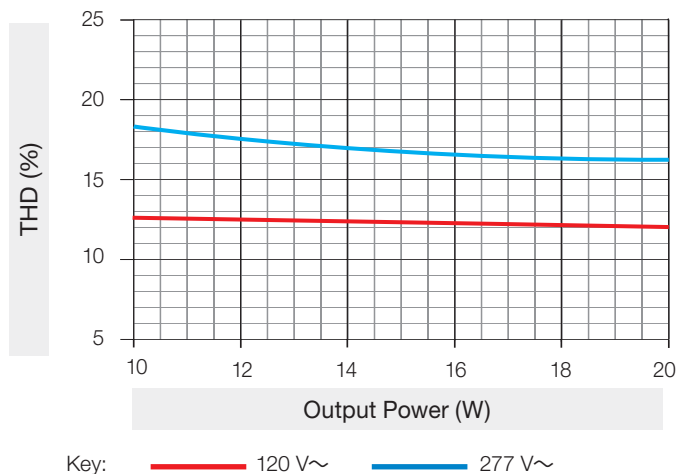

Typical Power Factor vs. Output Power

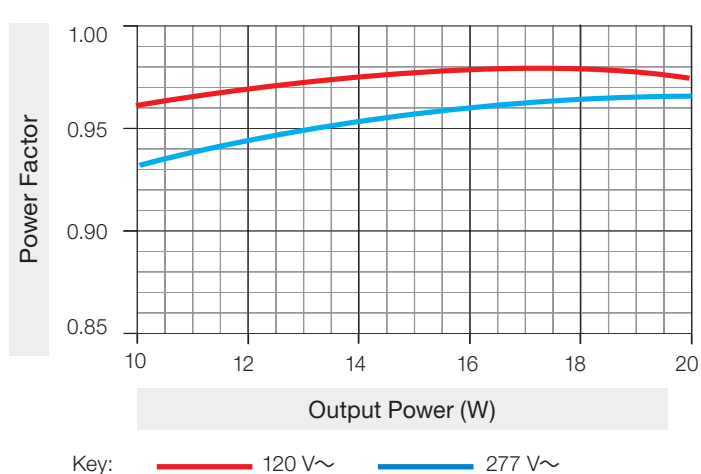

Job Name:	Model Numbers:
Job Number:	

M-Case Models: "B" Output Range

Driver Type	Output Voltage	Output Current	Output Power	Standards Recognition	Maximum Rated Temp. @ t _c for Warranty
Constant Current Driver (Class 2)	20–40 V ⁼⁼	0.50–1.25 A*	15–35 W	 US LISTED CLASS P E322469	75 °C

* QwikFig compatible model number LDE13U1UMN-BABLK is configurable to any current within this range in 0.01 A increments.

Typical Performance Specifications

Parameter	Value	Test Conditions
Input Current	0.15 A	V _i = 277 V [~] , t _a = 25 °C, I _o = 0.88 A, V _o = 40 V ⁼⁼ , Maximum Light Output LDE13U1UMN-BA088
Power Factor	0.96	
THD	15%	
Driver Efficiency	85%	

Load Compatibility

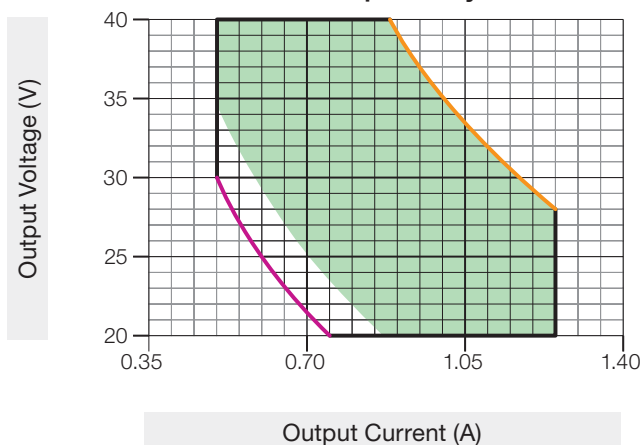

Key:
■ Shaded area meets DLC Version 2.1 (areas outside of shaded areas may not meet THD or PF requirements).
— Constant 15 W output — Constant 35 W output

Typical Efficiency vs. Output Current

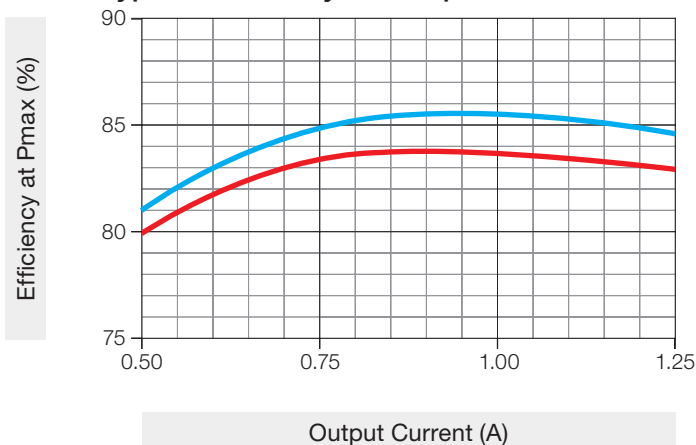

Key: — 120 V[~] — 277 V[~]

Typical THD vs. Output Power

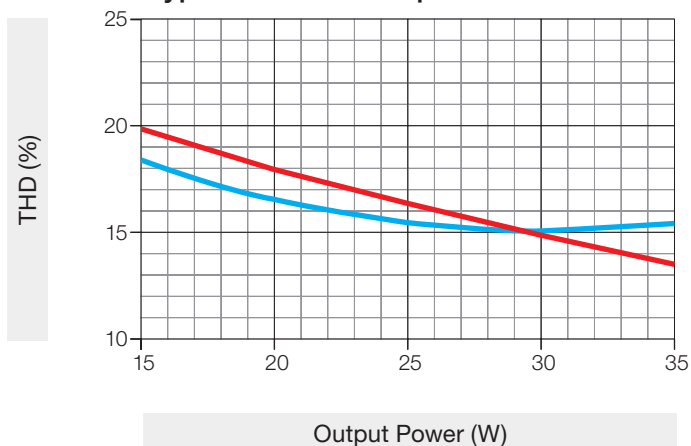

Key: — 120 V[~] — 277 V[~]

Typical Power Factor vs. Output Power

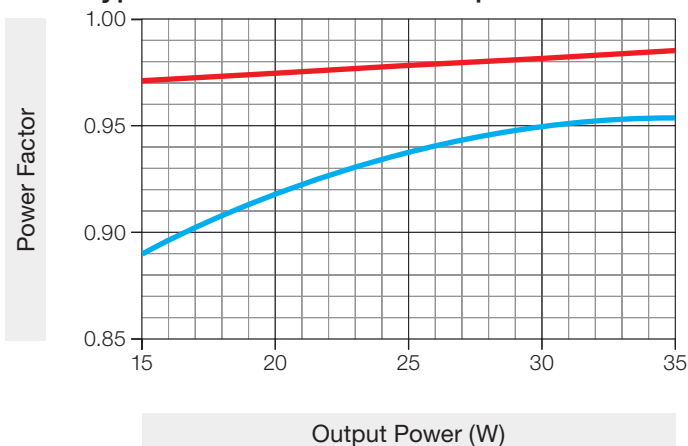

Key: — 120 V[~] — 277 V[~]

Job Name:	Model Numbers:
Job Number:	

M-Case Models: "C" Output Range

Driver Type	Output Voltage	Output Current	Output Power	Standards Recognition	Maximum Rated Temp. @ t _c for Warranty
Constant Current Driver (Class 2)	20–40 V $\overline{\sim}$	0.88–1.75 A*	25–50 W	US LISTED CLASS P E322469	75 °C

* QwikFig compatible model number LDE15U1UMN-CABLK is configurable to any current within this range in 0.01 A increments.

Typical Performance Specifications

Parameter	Value	Test Conditions
Input Current	0.21 A	V _i = 277 V $\overline{\sim}$, t _a = 25 °C, I _o = 1.25 A, V _o = 40 V $\overline{\sim}$, Maximum Light Output LDE15U1UMN-CA125
Power Factor	0.97	
THD	13%	
Driver Efficiency	88%	

Load Compatibility

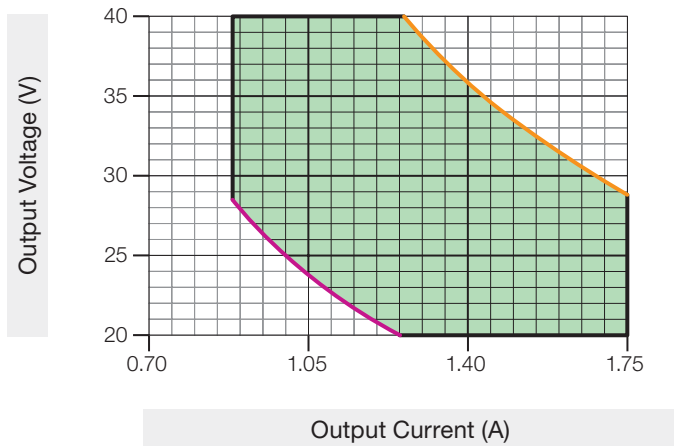

Key:
■ Shaded area meets DLC Version 2.1 (areas outside of shaded areas may not meet THD or PF requirements).
— Constant 25 W output — Constant 50 W output

Typical Efficiency vs. Output Current

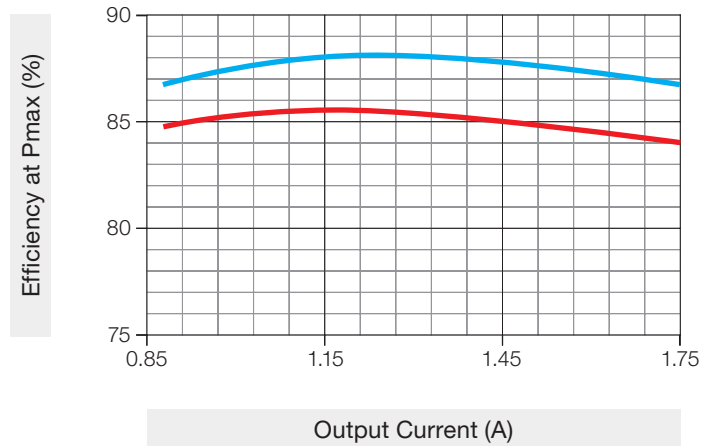

Key: — 120 V $\overline{\sim}$ — 277 V $\overline{\sim}$

Typical THD vs. Output Power

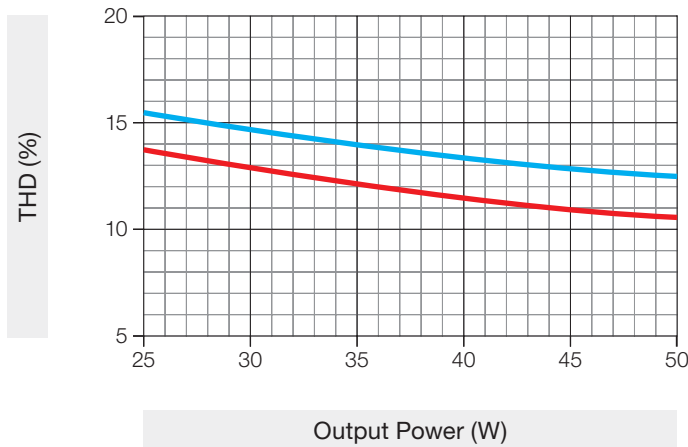

Key: — 120 V $\overline{\sim}$ — 277 V $\overline{\sim}$

Typical Power Factor vs. Output Power

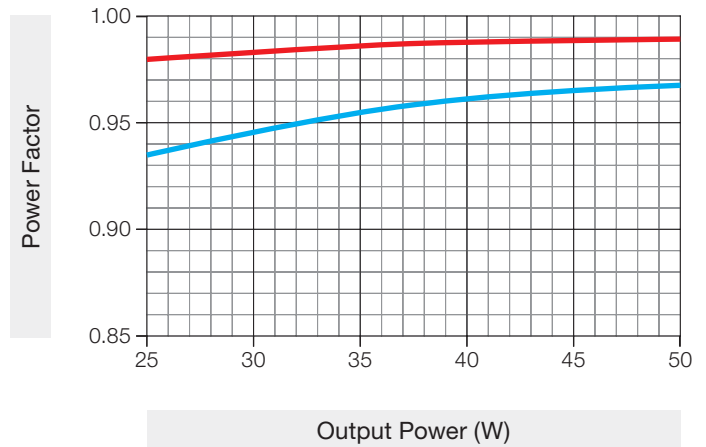

Key: — 120 V $\overline{\sim}$ — 277 V $\overline{\sim}$

Job Name:	Model Numbers:
Job Number:	

M-Case Models: "D" Output Range

Driver Type	Output Voltage	Output Current	Output Power	Standards Recognition	Maximum Rated Temp. @ t_c for Warranty
Constant Current Driver (Class 2)	20–40 V \sim	1.25–2.10 A*	35–75 W	 US LISTED CLASS P E322469	75 °C

* QwikFig compatible model number LDE17U1UMN-DABLK is configurable to any current within this range in 0.01 A increments.

Typical Performance Specifications

Parameter	Value	Test Conditions
Input Current	0.31 A	$V_i = 277\text{ V}\sim$, $t_a = 25\text{ }^\circ\text{C}$, $I_o = 1.88\text{ A}$, $V_o = 40\text{ V}\sim$, Maximum Light Output LDE17U1UMN-DA188
Power Factor	0.95	
THD	13%	
Driver Efficiency	89%	

Load Compatibility

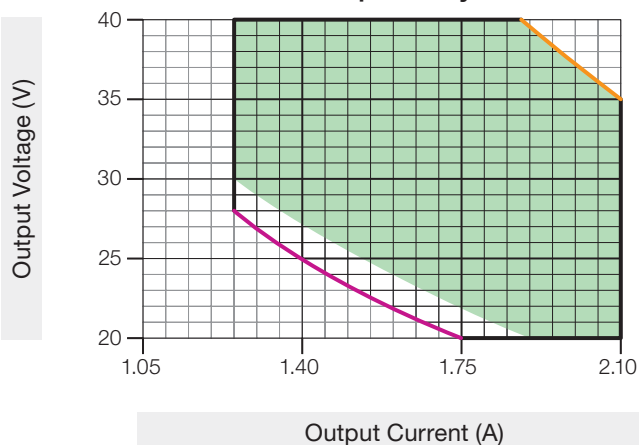

Key:
■ Shaded area meets DLC Version 2.1 (areas outside of shaded areas may not meet THD or PF requirements).
— Constant 35 W output — Constant 75 W output

Typical Efficiency vs. Output Current

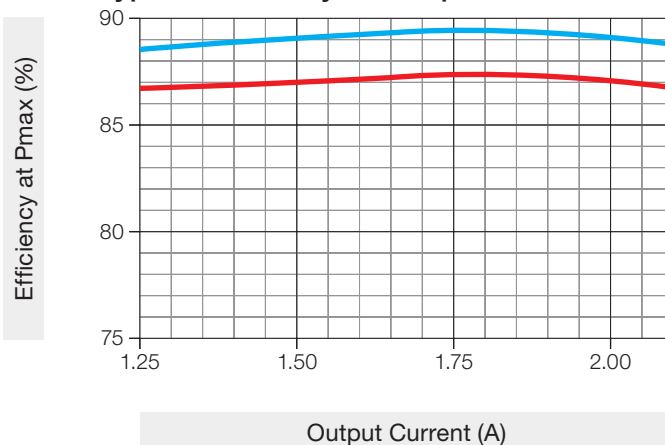

Key: — 120 V \sim — 277 V \sim

Typical THD vs. Output Power

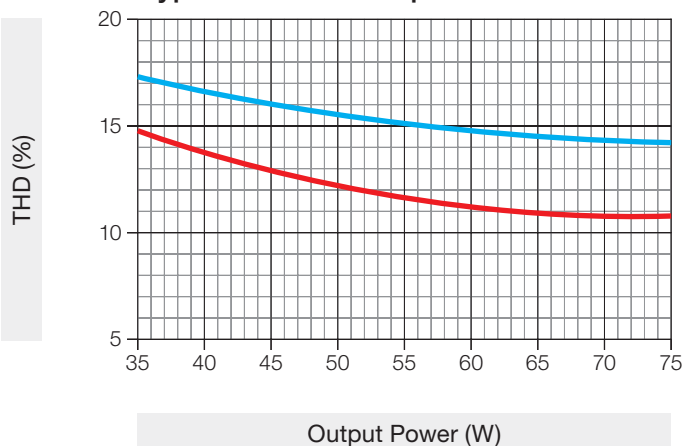

Key: — 120 V \sim — 277 V \sim

Typical Power Factor vs. Output Power

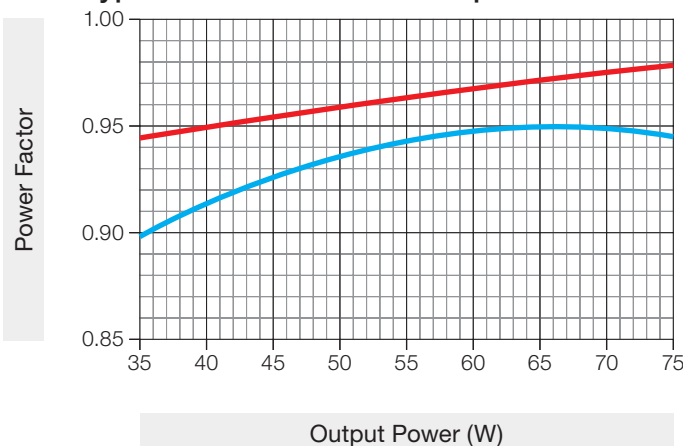

Key: — 120 V \sim — 277 V \sim

Job Name:	Model Numbers:
Job Number:	

M-Case Models: "J" Output Range

Driver Type	Output Voltage	Output Current	Output Power	Standards Recognition	Maximum Rated Temp. @ t _c for Warranty
Constant Current Driver (Class 2)	30–50 V $\overline{\sim}$	0.15–0.30 A*	6–12 W	US LISTED CLASS P E322469	75 °C

* QwikFig compatible model number LDE11U1UMN-JABLK is configurable to any current within this range in 0.01 A increments.

Typical Performance Specifications:

Parameter	Value	Test Conditions
Input Current	0.06 A	V _i = 277 V $\overline{\sim}$, t _a = 25 °C, I _o = 0.24 A, V _o = 50 V $\overline{\sim}$, Maximum Light Output LDE11U1UMN-JA024
Power Factor	0.93	
THD	19%	
Driver Efficiency	79%	

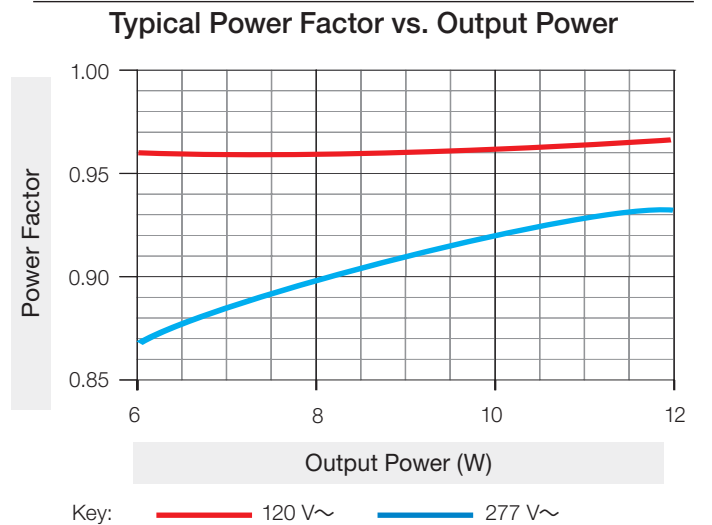
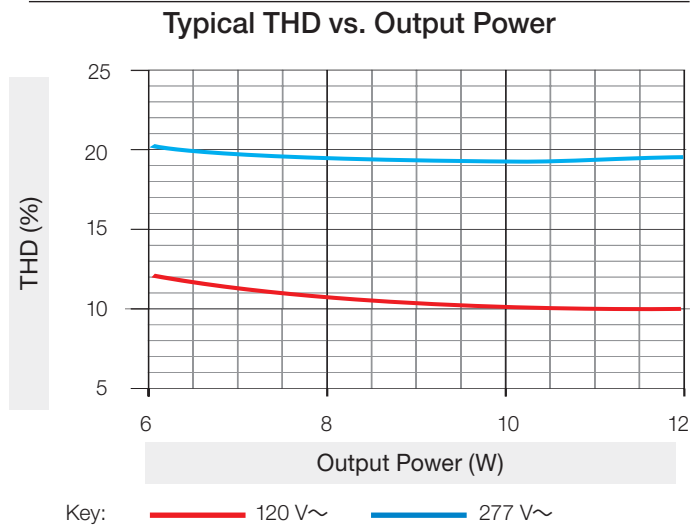
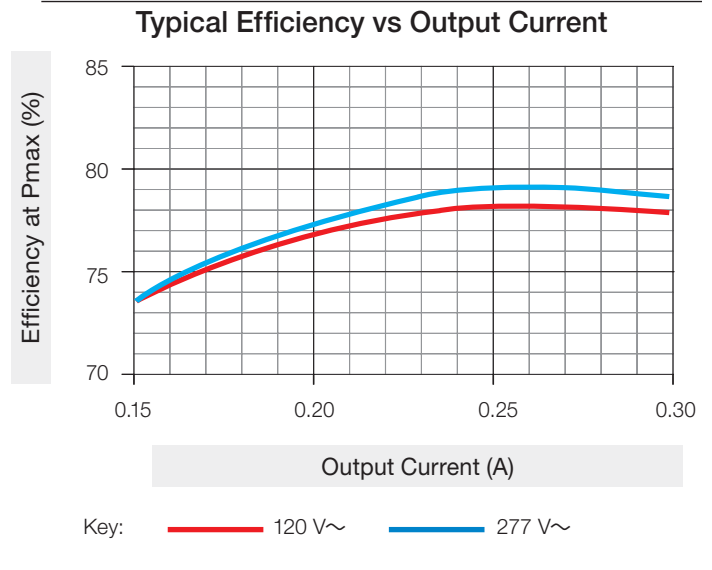
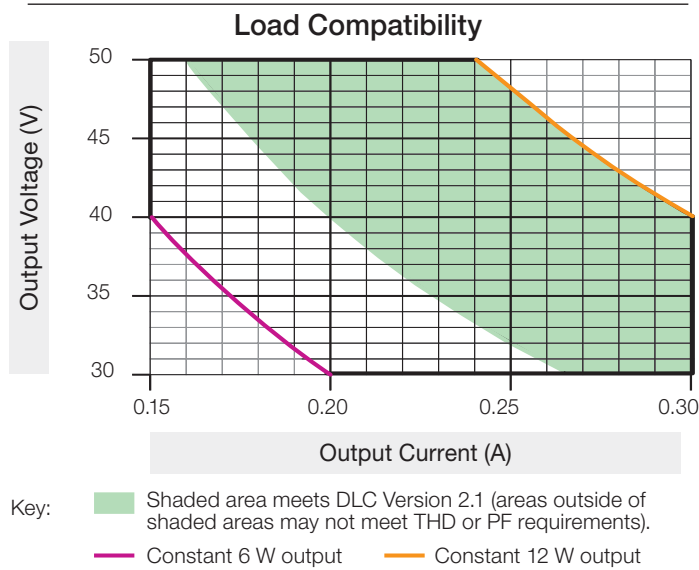

Job Name:	Model Numbers:
Job Number:	

M-Case Models: "K" Output Range

Driver Type	Output Voltage	Output Current	Output Power	Standards Recognition	Maximum Rated Temp. @ t _c for Warranty
Constant Current Driver (Class 2)	30–50 V ⁼⁼	0.24–0.50 A*	9–20 W		75 °C

* QwikFig compatible model number LDE12U1UMN-KABLK is configurable to any current within this range in 0.01 A increments.

Typical Performance Specifications:

Parameter	Value	Test Conditions
Input Current	0.09 A	V _i = 277 V [~] , t _a = 25 °C, I _o = 0.40 A, V _o = 50 V ⁼⁼ , Maximum Light Output LDE12U1UMN-KA040
Power Factor	0.96	
THD	18%	
Driver Efficiency	84%	

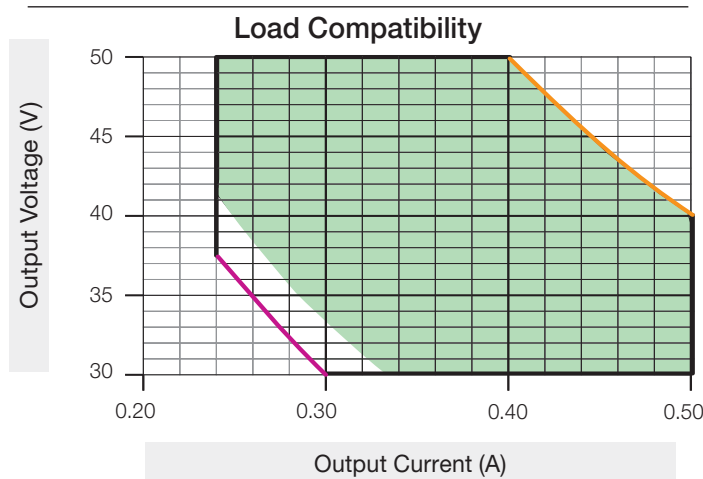

Key:
■ Shaded area meets DLC Version 2.1 (areas outside of shaded areas may not meet THD or PF requirements).
— Constant 9 W output — Constant 20 W output

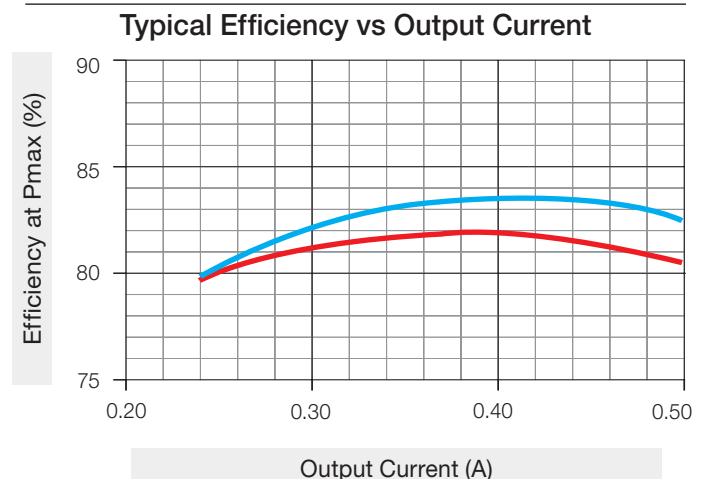

Key: — 120 V[~] — 277 V[~]

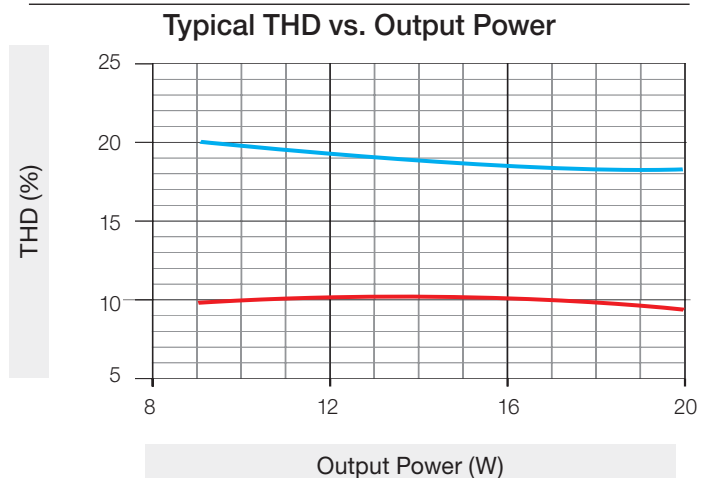

Key: — 120 V[~] — 277 V[~]

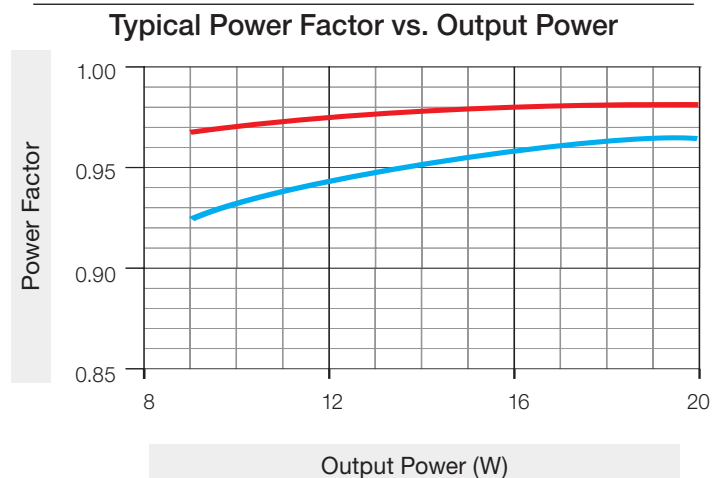

Key: — 120 V[~] — 277 V[~]

Job Name:	Model Numbers:
Job Number:	

M-Case Models: "T" Output Range

Driver Type	Output Voltage	Output Current	Output Power	Standards Recognition	Maximum Rated Temp. @ t _c for Warranty
Constant Current Driver (Class 2)	30–50 V $\overline{\sim}$	0.40–0.83 A*	15–35 W	US LISTED CLASS P E322469	75 °C

* QwikFig compatible model number LDE13U1UMN-TABLK is configurable to any current within this range in 0.01 A increments.

Typical Performance Specifications

Parameter	Value	Test Conditions
Input Current	0.15 A	V _i = 277 V $\overline{\sim}$, t _a = 25 °C, I _o = 0.70 A, V _o = 50 V $\overline{\sim}$, Maximum Light Output LDE13U1UMN-TA070
Power Factor	0.96	
THD	13%	
Driver Efficiency	87%	

Load Compatibility

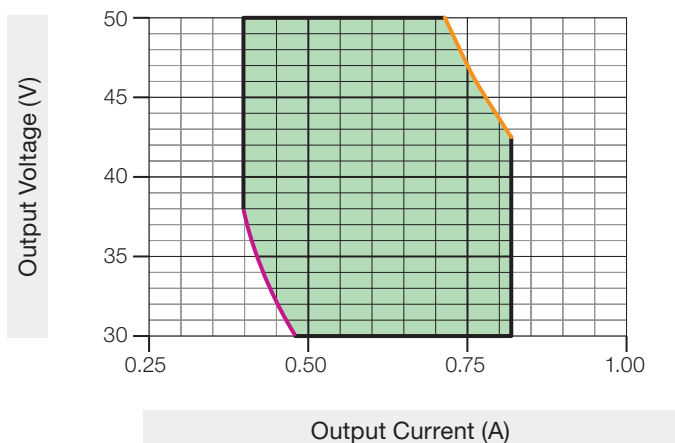

Key:
■ Shaded area meets DLC Version 2.1 (areas outside of shaded areas may not meet THD or PF requirements).
— Constant 15 W output — Constant 35 W output

Typical Efficiency vs. Output Current

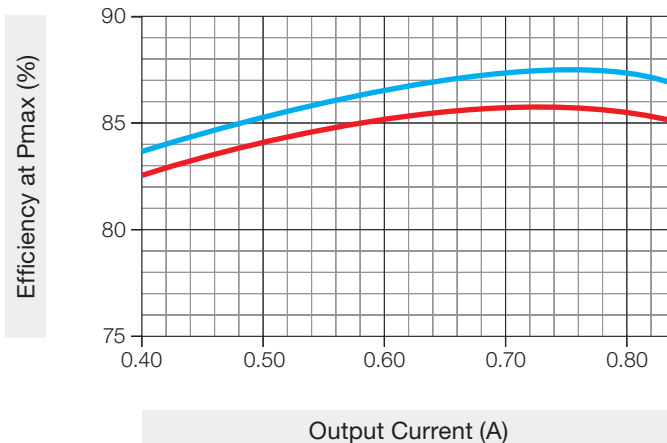

Key: — 120 V $\overline{\sim}$ — 277 V $\overline{\sim}$

Typical THD vs. Output Power

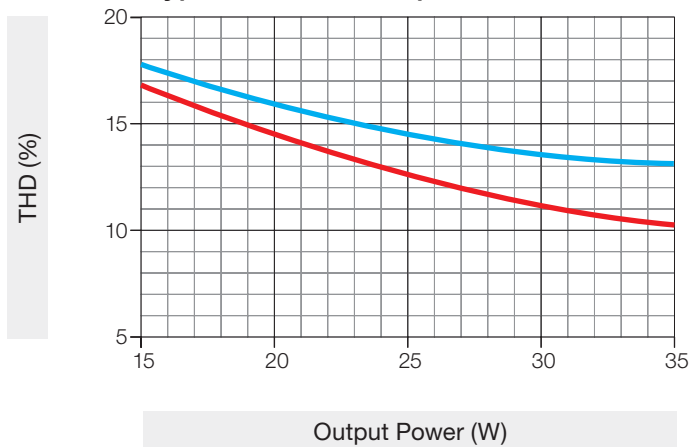

Key: — 120 V $\overline{\sim}$ — 277 V $\overline{\sim}$

Typical Power Factor vs. Output Power

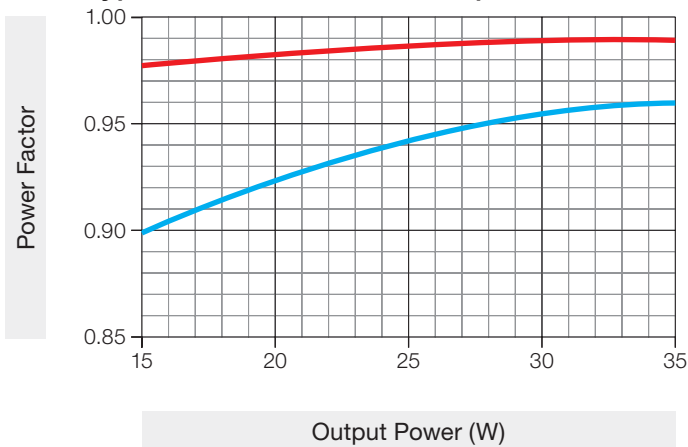

Key: — 120 V $\overline{\sim}$ — 277 V $\overline{\sim}$

Job Name:	Model Numbers:
Job Number:	

M-Case Models: "U" Output Range

Driver Type	Output Voltage	Output Current	Output Power	Standards Recognition	Maximum Rated Temp. @ t _c for Warranty
Constant Current Driver (Class 2)	30–50 V \sim	0.70–1.33 A*	25–50 W	 US LISTED CLASS P E322469	75 °C

* QwikFig compatible model number LDE15U1UMN-UABLK is configurable to any current within this range in 0.01 A increments.

Typical Performance Specifications

Parameter	Value	Test Conditions
Input Current	0.21 A	V _i = 277 V \sim , t _a = 25 °C, I _o = 1.0 A, V _o = 50 V \sim , Maximum Light Output LDE15U1UMN-UA100
Power Factor	0.97	
THD	11%	
Driver Efficiency	86%	

Load Compatibility

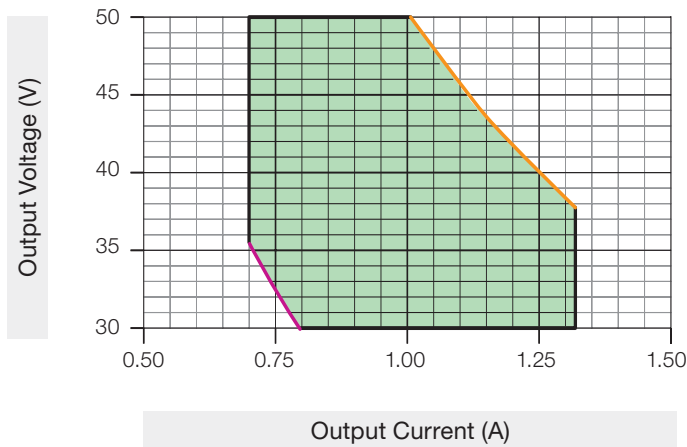

Key:
■ Shaded area meets DLC Version 2.1 (areas outside of shaded areas may not meet THD or PF requirements).
— Constant 25 W output — Constant 50 W output

Typical Efficiency vs. Output Current

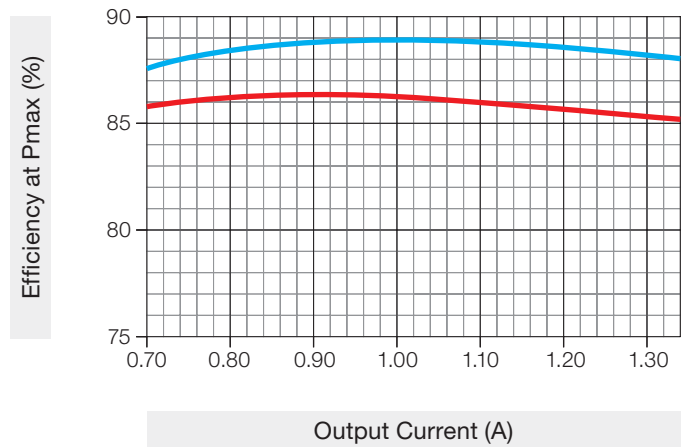

Key: — 120 V \sim — 277 V \sim

Typical THD vs. Output Power

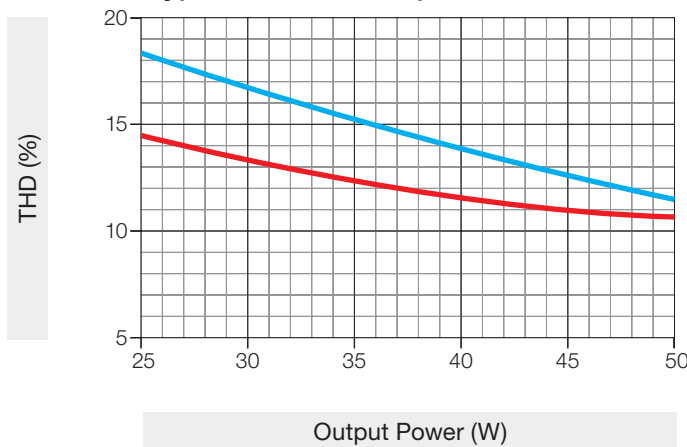

Key: — 120 V \sim — 277 V \sim

Typical Power Factor vs. Output Power

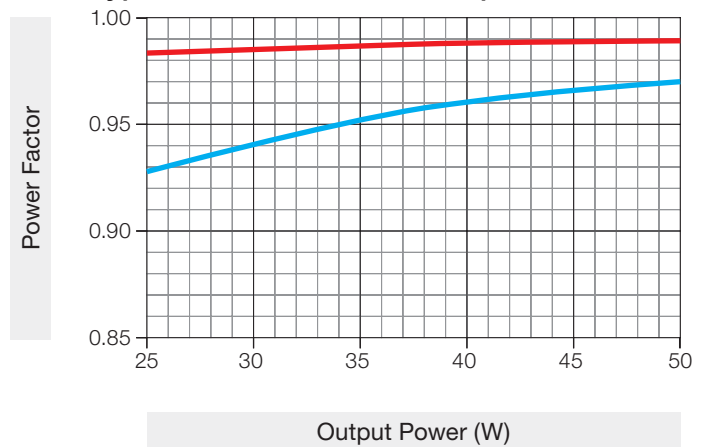

Key: — 120 V \sim — 277 V \sim

Job Name:	Model Numbers:
Job Number:	

M-Case Models: "V" Output Range

Driver Type	Output Voltage	Output Current	Output Power	Standards Recognition	Maximum Rated Temp. @ t _c for Warranty
Constant Current Driver (Class 2)	30–50 V \sim	1.00–1.88 A*	40–75 W	US LISTED CLASS P E322469	75 °C

* QwikFig compatible model number LDE17U1UMN-VABLK is configurable to any current within this range in 0.01 A increments.

Typical Performance Specifications

Parameter	Value	Test Conditions
Input Current	0.31 A	V _i = 277 V \sim , t _a = 25 °C, I _o = 1.5 A, V _o = 50 V \sim , Maximum Light Output LDE17U1UMN-VA150
Power Factor	0.96	
THD	13%	
Driver Efficiency	90%	

Load Compatibility

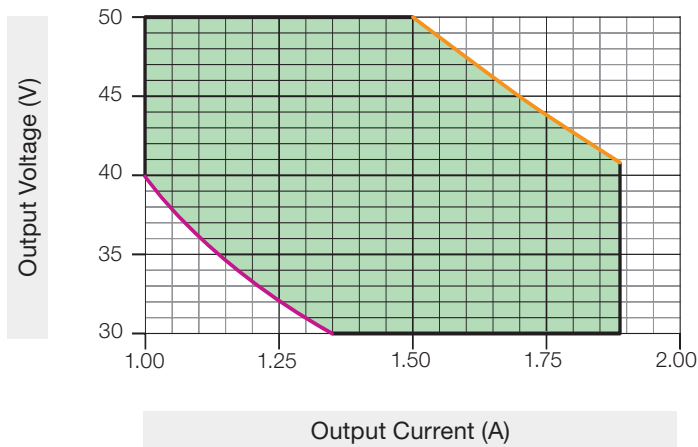

Key:
 Shaded area meets DLC Version 2.1 (areas outside of shaded areas may not meet THD or PF requirements).
— Constant 40 W output — Constant 75 W output

Typical Efficiency vs. Output Current

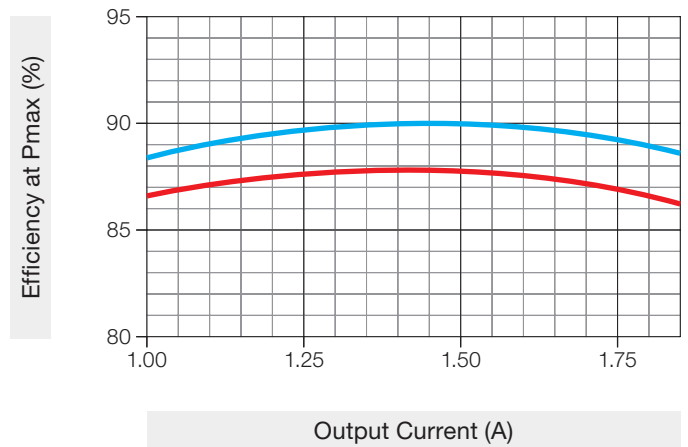

Key: — 120 V \sim — 277 V \sim

Typical THD vs. Output Power

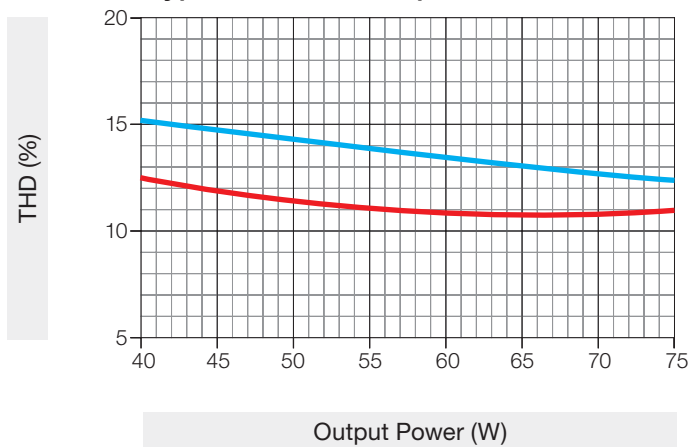

Key: — 120 V \sim — 277 V \sim

Typical Power Factor vs. Output Power

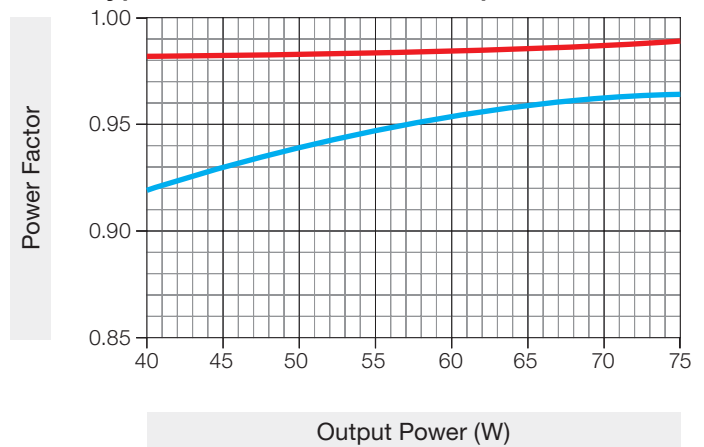

Key: — 120 V \sim — 277 V \sim

Job Name:	Model Numbers:
Job Number:	

How to Build a Model Number, K-Case Type (“BLK” models for use with Lutron QwikFig technology): Hi-lume 1% EcoSystem (up to 40 W) LED Driver with Soft-on, Fade-to-Black

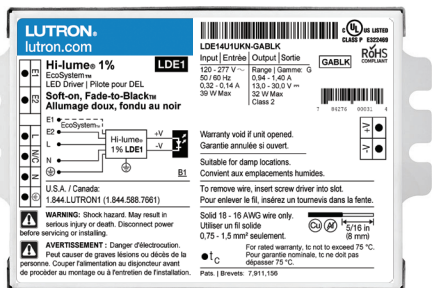

K-case type

L D E 1 4 U 1 U K - A

Case Style

- **S:** Studded (K-case only)
- **N:** Non-Studded

LED Load Output Range: Class 2 Constant Current
(see the following pages for more detail)

- **A:** 0.22–0.45 A, 21.0–50.0 V^{***}, 7–17.5 W
- **B:** 0.33–0.70 A, 30.0–50.0 V^{***}, 14–35 W
- **C:** 0.46–0.93 A, 16.0–37.1 V^{***}, 13–26 W
- **D:** 0.38–0.75 A, 12.0–30.2 V^{***}, 8–16 W
- **E:** 0.71–1.05 A, 31.0–50.0 V^{***}, 22–40 W
- **F:** 0.71–1.40 A, 19.0–38.0 V^{***}, 21–40 W
- **G:** 0.94–1.40 A, 13.0–30.0 V^{***}, 18.5–32 W
- **H:** 0.63–1.05 A, 10.0–21.0 V^{***}, 8–18 W

Current Level (for Constant-Current)

- **022** = 0.22 A
- **140** = 1.40 A

Option 1: Order a driver configured by Lutron to a desired output current.

Example: LDE14U1UKN-BA070 has been pre-configured at Lutron to an output of 0.70 A. Refer to the example above.

Note: Lutron pre-configured drivers are *not* QwikFig compatible and cannot be re-configured.

Option 2: Order a QwikFig compatible driver.

Example: LDE14U1UKN-BABLK (0.33–0.70 A)*

Note: Default set to minimum output current for the respective **LED Load Output Range**.

Example: LDE14U1UKN-BA070

- 0.70 A
- 21–35 W**
- Non-studded case LED driver

For further assistance in selecting your model number, contact our LED Center of Excellence at **LEDs@lutron.com**

** Minimum and maximum wattages derived from minimum and maximum compatible load voltages at 0.7 A:
0.7 A × 30 V = 21 W; 0.7 A × 50 V = 35 W

Attention: Model numbers may appear similar to Lutron Hi-lume 1% EcoSystem, Hi-lume 1% 3-wire or Hi-lume 1% 2-wire drivers, but they are not direct model-for-model replacements. Please note the driver’s output rating and the load ratings to select the correct product for your fixture.

* Output voltage range changes with output current and according to power limits. Check driver specifications on the following pages carefully to understand output voltage range of a particular SKU. Purchaser is responsible for electrical compatibility between LED driver and LED load.

LUTRON SPECIFICATION SUBMITTAL		Page
Job Name:	Model Numbers:	
Job Number:		

K-Case Models: "A" Output Range

Driver Type	Output Voltage	Output Current	Output Power	Standards Recognition	Maximum Rated Temp. @ t _c for Warranty
Constant Current Driver (Class 2)	21–50 V \sim	0.22–0.45 A*	7–17.5 W	 US LISTED CLASS P E322469	75 °C

* QwikFig compatible model number LDE14U1UKx-AABLK is configurable to any current within this range in 0.01 A increments. "x" in the model number is either "S" (Studded) or "N" (Non-Studded).

Typical Performance Specifications

Parameter	Value	Test Conditions
Input Current	0.09 A	V _i = 277 V \sim , t _a = 25 °C, I _o = 0.45 A, V _o = 38.9 V \sim , Maximum Light Output LDE14U1UKN-AA045
Power Factor	0.88	
THD	17%	
Driver Efficiency	83%	

Load Compatibility

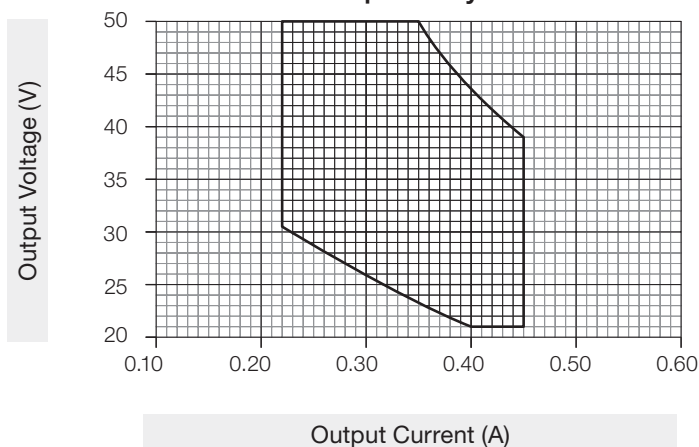

Typical Efficiency vs. Output Current

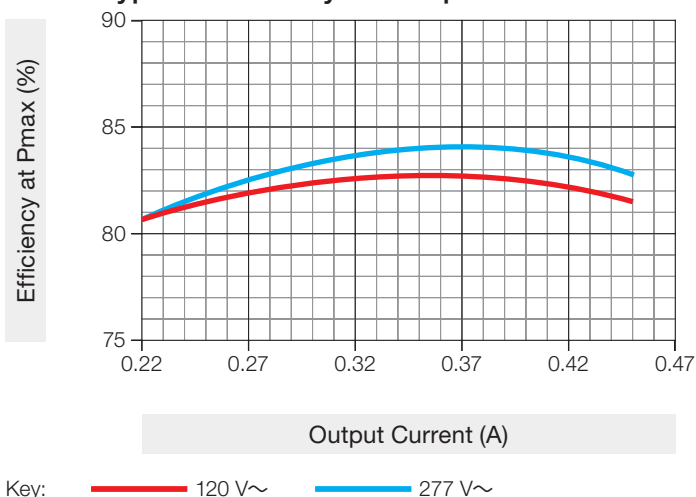

Typical THD vs. Output Power

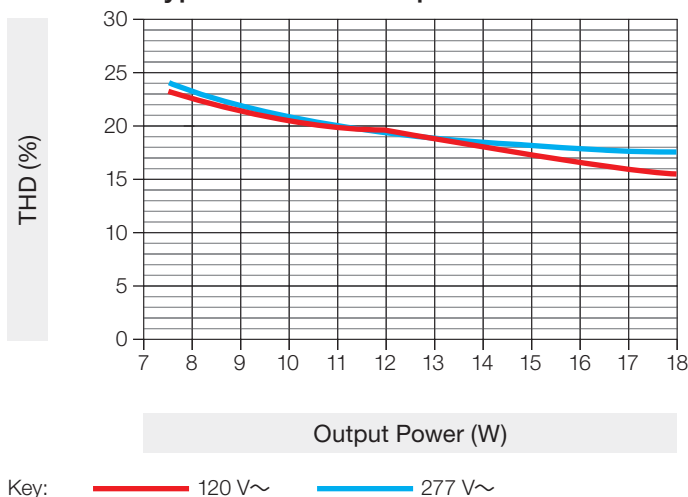

Typical Power Factor vs. Output Power

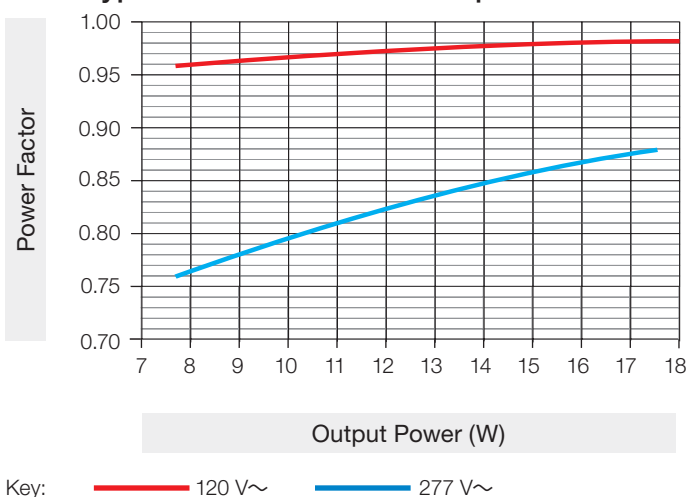

continued on next page...

Job Name:	Model Numbers:
Job Number:	

K-Case Models: "A" Output Range (continued)

Output Current and Compatible Load Voltage

Model Number* LDE14U1UKS/N	Rated Output Current (A)	Compatible Load Voltage (V)		Typical Performance at Minimum Compatible Load Voltage			Typical Performance at Maximum Compatible Load Voltage		
		Minimum	Maximum	Power Factor @ 120 V/277 V	THD @ 120 V/277 V	Efficiency @ 120 V/277 V	Power Factor @ 120 V/277 V	THD @ 120 V/277 V	Efficiency @ 120 V/277 V
-AA022	0.22	30.5	50.0	0.94/0.73	25%/26%	76%/75%	0.97/0.81	20%/20%	80%/80%
-AA023	0.23	29.9	50.0	0.94/0.74	25%/26%	77%/76%	0.97/0.81	20%/19%	81%/81%
-AA024	0.24	29.3	50.0	0.95/0.74	24%/25%	77%/76%	0.97/0.83	19%/19%	81%/81%
-AA025	0.25	28.7	50.0	0.95/0.74	24%/25%	77%/76%	0.97/0.83	19%/19%	81%/82%
-AA026	0.26	28.1	50.0	0.95/0.75	24%/25%	77%/76%	0.97/0.84	19%/19%	81%/82%
-AA027	0.27	27.6	50.0	0.95/0.75	23%/24%	77%/76%	0.98/0.84	18%/18%	82%/82%
-AA028	0.28	27.0	50.0	0.95/0.76	23%/24%	77%/76%	0.98/0.85	18%/18%	82%/83%
-AA029	0.29	26.4	50.0	0.96/0.76	23%/24%	76%/76%	0.98/0.85	18%/18%	82%/83%
-AA030	0.30	25.9	50.0	0.96/0.76	23%/24%	76%/76%	0.98/0.86	17%/18%	82%/83%
-AA031	0.31	25.4	50.0	0.96/0.76	23%/23%	76%/76%	0.98/0.86	17%/18%	82%/83%
-AA032	0.32	24.9	50.0	0.96/0.77	23%/23%	76%/76%	0.98/0.87	17%/18%	82%/83%
-AA033	0.33	24.3	50.0	0.96/0.77	23%/23%	76%/76%	0.98/0.87	16%/18%	82%/83%
-AA034	0.34	23.8	50.0	0.96/0.77	23%/23%	76%/76%	0.98/0.87	16%/18%	82%/84%
-AA035	0.35	23.3	50.0	0.96/0.77	23%/23%	75%/75%	0.98/0.88	16%/17%	83%/84%
-AA036	0.36	22.9	48.6	0.96/0.77	23%/23%	75%/75%	0.98/0.88	16%/17%	83%/84%
-AA037	0.37	22.4	47.3	0.96/0.77	23%/23%	75%/74%	0.98/0.88	16%/17%	83%/84%
-AA038	0.38	21.9	46.1	0.96/0.77	23%/23%	74%/74%	0.98/0.88	16%/17%	82%/84%
-AA039	0.39	21.4	44.9	0.96/0.77	22%/23%	74%/74%	0.98/0.88	16%/17%	82%/84%
-AA040	0.40	21.0	43.8	0.96/0.77	22%/23%	74%/74%	0.98/0.88	16%/17%	82%/84%
-AA041	0.41	21.0	42.7	0.96/0.77	22%/22%	74%/74%	0.98/0.88	16%/17%	82%/83%
-AA042	0.42	21.0	41.7	0.96/0.77	22%/22%	74%/74%	0.98/0.88	16%/17%	82%/83%
-AA043	0.43	21.0	40.7	0.97/0.78	22%/22%	74%/74%	0.98/0.88	16%/17%	82%/83%
-AA044	0.44	21.0	39.8	0.97/0.79	21%/21%	74%/74%	0.98/0.88	16%/17%	81%/83%
-AA045	0.45	21.0	38.9	0.97/0.79	21%/21%	74%/74%	0.98/0.88	16%/17%	81%/83%

* See [How to Build a Model Number, K-Case Type](#) page for a sample model number.

Job Name:	Model Numbers:
Job Number:	

K-Case Models: "B" Output Range

Driver Type	Output Voltage	Output Current	Output Power	Standards Recognition	Maximum Rated Temp. @ t _c for Warranty
Constant Current Driver (Class 2)	30–50 V $\overline{=}$	0.33–0.70 A*	14–35 W	US LISTED CLASS P E322469	75 °C

* QwikFig compatible model number LDE14U1UKx-BABLK is configurable to any current within this range in 0.01 A increments. "x" in the model number is either "S" (Studded) or "N" (Non-Studded).

Typical Performance Specifications

Parameter	Value	Test Conditions
Input Current	0.15 A	V _i = 277 V $\overline{\sim}$, t _a = 25 °C, I _o = 0.7 A, V _o = 50 V $\overline{=}$, Maximum Light Output LDE14U1UKN-BA070
Power Factor	0.96	
THD	17%	
Driver Efficiency	87%	

Load Compatibility

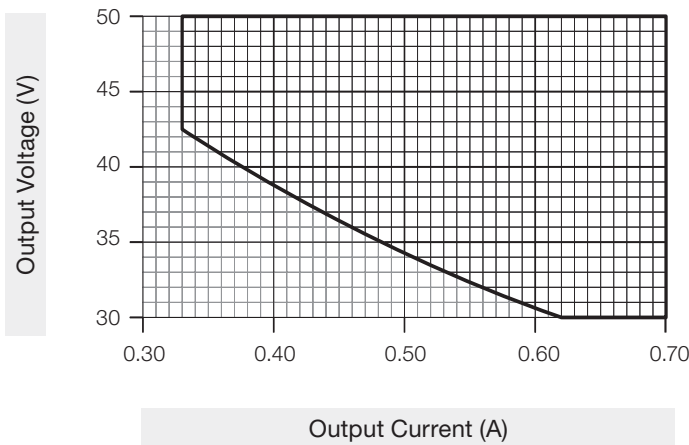

Typical Efficiency vs. Output Current

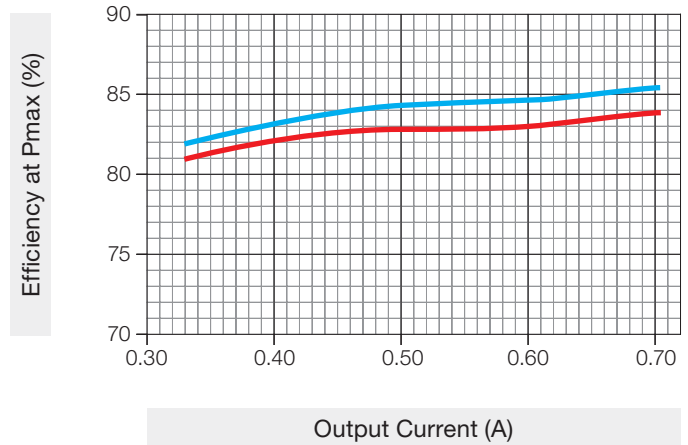

Key: — 120 V $\overline{\sim}$ — 277 V $\overline{\sim}$

Typical THD vs. Output Power

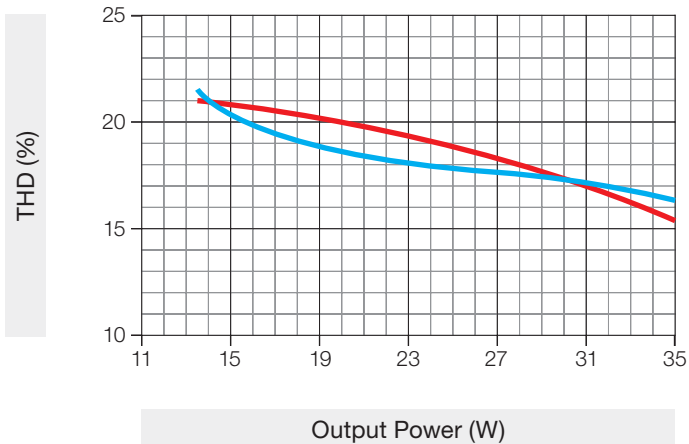

Key: — 120 V $\overline{\sim}$ — 277 V $\overline{\sim}$

Typical Power Factor vs. Output Power

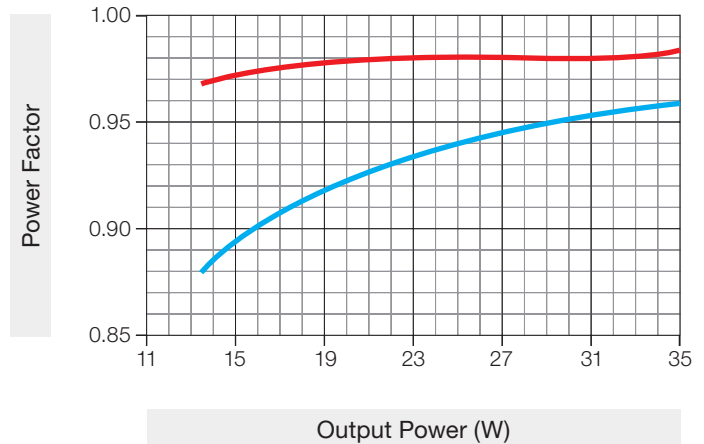

Key: — 120 V $\overline{\sim}$ — 277 V $\overline{\sim}$

continued on next page...

Job Name:	Model Numbers:
Job Number:	

K-Case Models: “B” Output Range (continued)

Output Current and Compatible Load Voltage

Model Number* LDE14U1UKS/N	Rated Output Current (A)	Compatible Load Voltage (V)		Typical Performance at Minimum Compatible Load Voltage			Typical Performance at Maximum Compatible Load Voltage		
		Minimum	Maximum	Power Factor @ 120 V/277 V	THD @ 120 V/277 V	Efficiency @ 120 V/277 V	Power Factor @ 120 V/277 V	THD @ 120 V/277 V	Efficiency @ 120 V/277 V
-BA033	0.33	42.5	50.0	0.97/0.88	21%/21%	80%/81%	0.97/0.90	21%/20%	81%/82%
-BA034	0.34	41.9	50.0	0.97/0.88	21%/21%	80%/81%	0.98/0.91	21%/20%	81%/82%
-BA035	0.35	41.3	50.0	0.97/0.89	21%/21%	80%/81%	0.98/0.91	20%/20%	81%/82%
-BA036	0.36	40.7	50.0	0.97/0.89	21%/21%	80%/81%	0.98/0.91	20%/19%	81%/82%
-BA037	0.37	40.2	50.0	0.97/0.89	21%/21%	80%/82%	0.98/0.92	20%/19%	82%/83%
-BA038	0.38	39.6	50.0	0.97/0.89	21%/21%	80%/82%	0.98/0.92	20%/19%	82%/83%
-BA039	0.39	39.1	50.0	0.97/0.89	21%/21%	81%/82%	0.98/0.92	20%/19%	82%/83%
-BA040	0.40	38.5	50.0	0.97/0.90	21%/21%	81%/82%	0.98/0.92	20%/19%	82%/83%
-BA041	0.41	38.0	50.0	0.97/0.90	21%/20%	81%/82%	0.98/0.93	20%/18%	82%/83%
-BA042	0.42	37.5	50.0	0.97/0.90	21%/20%	81%/82%	0.98/0.93	20%/18%	82%/83%
-BA043	0.43	37.0	50.0	0.97/0.90	21%/20%	81%/82%	0.98/0.93	20%/18%	82%/84%
-BA044	0.44	36.5	50.0	0.97/0.90	21%/20%	81%/82%	0.98/0.93	20%/18%	82%/84%
-BA045	0.45	36.1	50.0	0.97/0.90	21%/20%	81%/82%	0.98/0.93	20%/18%	82%/84%
-BA046	0.46	35.6	50.0	0.97/0.90	21%/20%	81%/82%	0.98/0.93	19%/18%	82%/84%
-BA047	0.47	35.2	50.0	0.97/0.91	21%/20%	81%/82%	0.98/0.94	19%/18%	82%/84%
-BA048	0.48	34.7	50.0	0.97/0.91	21%/20%	81%/82%	0.98/0.94	19%/18%	83%/84%
-BA049	0.49	34.3	50.0	0.98/0.91	21%/20%	81%/82%	0.98/0.94	19%/18%	83%/84%
-BA050	0.50	33.9	50.0	0.98/0.91	21%/20%	81%/82%	0.98/0.94	19%/18%	83%/84%
-BA051	0.51	33.5	50.0	0.98/0.91	21%/20%	81%/82%	0.98/0.94	19%/18%	83%/84%
-BA052	0.52	33.1	50.0	0.98/0.91	20%/19%	81%/82%	0.98/0.94	19%/18%	83%/84%
-BA053	0.53	32.8	50.0	0.98/0.91	20%/19%	81%/82%	0.98/0.94	19%/18%	83%/84%
-BA054	0.54	32.4	50.0	0.98/0.91	20%/19%	81%/82%	0.98/0.94	18%/18%	83%/84%
-BA055	0.55	32.1	50.0	0.98/0.91	20%/19%	81%/82%	0.98/0.95	18%/18%	83%/84%
-BA056	0.56	31.7	50.0	0.98/0.91	20%/19%	81%/82%	0.98/0.95	18%/17%	83%/84%
-BA057	0.57	31.4	50.0	0.98/0.91	20%/19%	81%/82%	0.98/0.95	18%/17%	83%/84%
-BA058	0.58	31.1	50.0	0.98/0.91	20%/19%	81%/82%	0.98/0.95	18%/17%	83%/84%
-BA059	0.59	30.8	50.0	0.98/0.91	20%/19%	81%/82%	0.98/0.95	18%/17%	83%/84%
-BA060	0.60	30.5	50.0	0.98/0.91	20%/19%	81%/82%	0.98/0.95	18%/17%	83%/84%
-BA061	0.61	30.3	50.0	0.98/0.92	20%/19%	81%/82%	0.98/0.95	17%/17%	83%/85%
-BA062	0.62	30.0	50.0	0.98/0.92	20%/19%	81%/82%	0.98/0.95	17%/17%	83%/85%
-BA063	0.63	30.0	50.0	0.98/0.92	20%/19%	81%/83%	0.98/0.95	17%/17%	83%/85%
-BA064	0.64	30.0	50.0	0.98/0.92	20%/19%	81%/83%	0.98/0.96	17%/17%	83%/85%
-BA065	0.65	30.0	50.0	0.98/0.92	20%/19%	81%/83%	0.98/0.96	17%/17%	83%/85%
-BA066	0.66	30.0	50.0	0.98/0.92	20%/19%	82%/83%	0.98/0.96	16%/17%	83%/85%
-BA067	0.67	30.0	50.0	0.98/0.92	20%/19%	82%/83%	0.98/0.96	16%/17%	83%/85%
-BA068	0.68	30.0	50.0	0.98/0.92	20%/18%	82%/83%	0.98/0.96	16%/17%	83%/85%
-BA069	0.69	30.0	50.0	0.98/0.93	20%/18%	82%/83%	0.98/0.96	16%/16%	84%/85%
-BA070	0.70	30.0	50.0	0.98/0.93	20%/18%	82%/83%	0.98/0.96	16%/16%	84%/85%

* See How to Build a Model Number, K-Case Type page for a sample model number.



Job Name:	Model Numbers:
Job Number:	

K-Case Models: "C" Output Range

Driver Type	Output Voltage	Output Current	Output Power	Standards Recognition	Maximum Rated Temp. @ t_c for Warranty
Constant Current Driver (Class 2)	16–37.1 V \equiv	0.46–0.93 A*	13–26 W	 US LISTED CLASS P E322469	75 °C

* QwikFig compatible model number LDE14U1UKx-CABLK is configurable to any current within this range in 0.01 A increments. "x" in the model number is either "S" (Studded) or "N" (Non-Studded).

Typical Performance Specifications

Parameter	Value	Test Conditions
Input Current	0.12 A	$V_i = 277\text{ V}\sim$, $t_a = 25\text{ }^\circ\text{C}$, $I_o = 0.93\text{ A}$, $V_o = 28\text{ V}\equiv$, Maximum Light Output LDE14U1UKN-CA093
Power Factor	0.95	
THD	16%	
Driver Efficiency	83%	

Load Compatibility

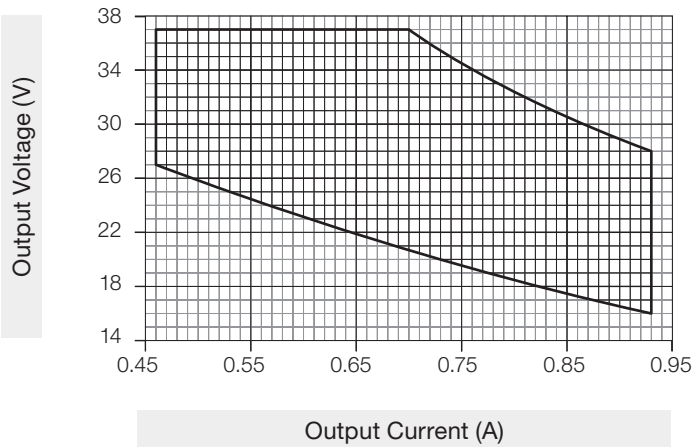

Typical Efficiency vs. Output Current

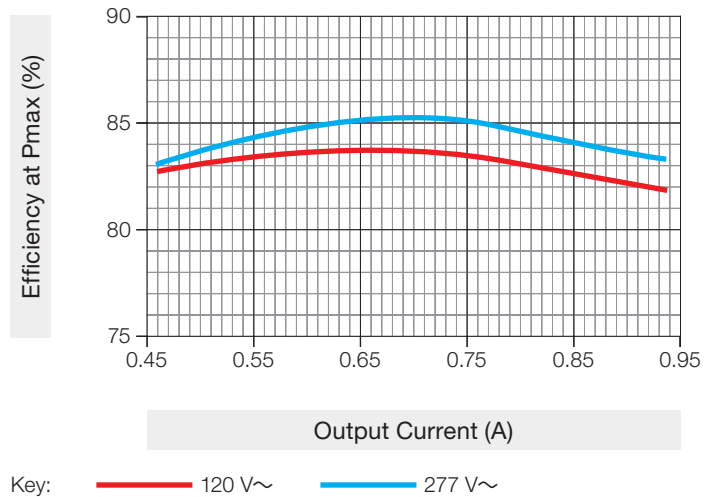

Typical THD vs. Output Power

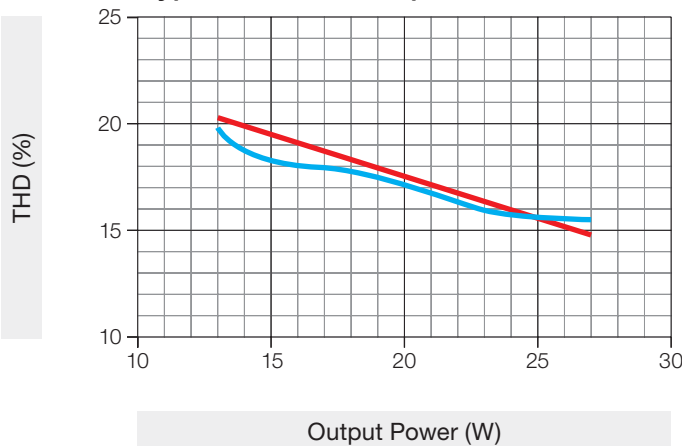

Typical Power Factor vs. Output Power

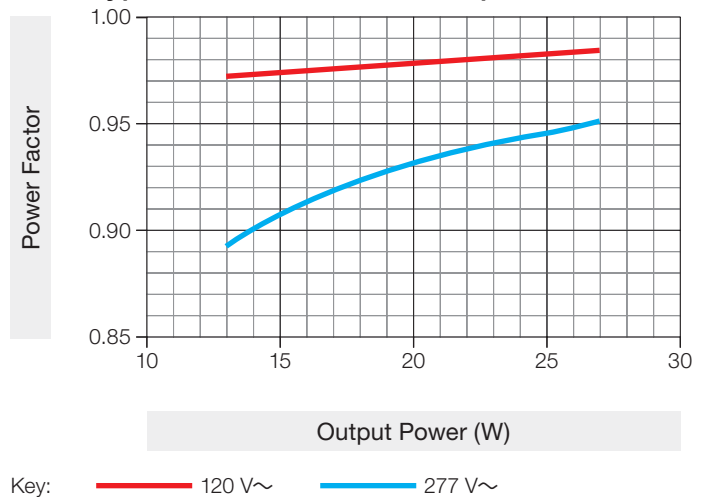

Key: — 120 V \sim — 277 V \sim

Key: — 120 V \sim — 277 V \sim

continued on next page...

Job Name:	Model Numbers:
Job Number:	

K-Case Models: "C" Output Range (continued)

Output Current and Compatible Load Voltage

Model Number* LDE14U1UKS/N	Rated Output Current (A)	Compatible Load Voltage (V)		Typical Performance at Minimum Compatible Load Voltage			Typical Performance at Maximum Compatible Load Voltage		
		Minimum	Maximum	Power Factor @ 120 V/277 V	THD @ 120 V/277 V	Efficiency @ 120 V/277 V	Power Factor @ 120 V/277 V	THD @ 120 V/277 V	Efficiency @ 120 V/277 V
-CA046	0.46	27.1	37.1	0.97/0.89	21%/20%	80%/80%	0.98/0.92	19%/18%	83%/83%
-CA047	0.47	26.8	37.1	0.97/0.89	21%/20%	80%/80%	0.98/0.92	19%/18%	83%/83%
-CA048	0.48	26.5	37.1	0.97/0.89	21%/20%	80%/80%	0.98/0.92	18%/18%	83%/83%
-CA049	0.49	26.2	37.1	0.97/0.90	21%/20%	80%/80%	0.98/0.92	18%/18%	83%/84%
-CA050	0.50	25.9	37.1	0.97/0.90	20%/19%	80%/80%	0.98/0.92	18%/18%	83%/84%
-CA051	0.51	25.6	37.1	0.97/0.90	20%/19%	80%/80%	0.98/0.93	18%/17%	83%/84%
-CA052	0.52	25.3	37.1	0.97/0.90	20%/19%	80%/80%	0.98/0.93	18%/17%	83%/84%
-CA053	0.53	25.0	37.1	0.97/0.90	20%/19%	80%/80%	0.98/0.93	18%/17%	83%/84%
-CA054	0.54	24.7	37.1	0.97/0.90	20%/19%	80%/80%	0.98/0.93	18%/17%	84%/84%
-CA055	0.55	24.4	37.1	0.97/0.90	20%/19%	80%/80%	0.98/0.93	17%/17%	84%/84%
-CA056	0.56	24.2	37.1	0.97/0.90	20%/19%	80%/80%	0.98/0.93	17%/17%	84%/85%
-CA057	0.57	23.9	37.1	0.97/0.90	20%/19%	80%/80%	0.98/0.93	17%/17%	84%/85%
-CA058	0.58	23.6	37.1	0.97/0.90	20%/19%	79%/80%	0.98/0.93	17%/17%	84%/85%
-CA059	0.59	23.3	37.1	0.97/0.90	20%/19%	79%/80%	0.98/0.94	17%/16%	84%/85%
-CA060	0.60	23.1	37.1	0.97/0.90	20%/19%	79%/80%	0.98/0.94	17%/16%	84%/85%
-CA061	0.61	22.8	37.1	0.97/0.90	20%/19%	79%/80%	0.98/0.94	17%/16%	84%/85%
-CA062	0.62	22.5	37.1	0.97/0.90	20%/19%	79%/80%	0.98/0.94	16%/16%	84%/85%
-CA063	0.63	22.3	37.1	0.97/0.90	20%/19%	79%/80%	0.98/0.94	16%/16%	84%/85%
-CA064	0.64	22.0	37.1	0.97/0.90	20%/19%	79%/80%	0.98/0.94	16%/16%	84%/85%
-CA065	0.65	21.8	37.1	0.97/0.90	20%/19%	79%/80%	0.98/0.94	16%/16%	84%/85%
-CA066	0.66	21.5	37.1	0.97/0.90	20%/19%	79%/79%	0.98/0.94	16%/16%	84%/85%
-CA067	0.67	21.3	37.1	0.97/0.90	20%/19%	79%/79%	0.98/0.94	16%/16%	84%/85%
-CA068	0.68	21.0	37.1	0.97/0.90	20%/19%	79%/79%	0.98/0.94	15%/16%	84%/85%
-CA069	0.69	20.8	37.1	0.97/0.90	20%/19%	79%/79%	0.98/0.95	15%/16%	84%/85%
-CA070	0.70	20.6	37.1	0.97/0.90	20%/19%	79%/79%	0.98/0.95	15%/16%	84%/85%
-CA071	0.71	20.3	36.6	0.97/0.90	20%/19%	78%/79%	0.98/0.95	15%/16%	84%/85%
-CA072	0.72	20.1	36.1	0.97/0.90	20%/18%	78%/79%	0.98/0.95	15%/16%	84%/85%
-CA073	0.73	19.9	35.6	0.97/0.90	20%/18%	78%/79%	0.98/0.95	15%/16%	84%/85%
-CA074	0.74	19.6	35.1	0.97/0.90	20%/18%	78%/79%	0.98/0.95	15%/16%	84%/85%
-CA075	0.75	19.4	34.7	0.97/0.90	20%/18%	78%/79%	0.98/0.95	15%/16%	83%/85%
-CA076	0.76	19.2	34.2	0.97/0.90	20%/18%	78%/79%	0.98/0.95	15%/16%	83%/85%
-CA077	0.77	19.0	33.8	0.97/0.90	20%/18%	78%/78%	0.98/0.95	15%/16%	83%/85%
-CA078	0.78	18.8	33.3	0.97/0.90	20%/18%	78%/78%	0.98/0.95	15%/16%	83%/85%
-CA079	0.79	18.6	32.9	0.97/0.90	19%/18%	78%/78%	0.98/0.95	15%/16%	83%/85%
-CA080	0.80	18.4	32.5	0.97/0.90	19%/18%	77%/78%	0.98/0.95	15%/16%	83%/85%
-CA081	0.81	18.2	32.1	0.97/0.91	19%/18%	77%/78%	0.98/0.95	15%/16%	83%/84%
-CA082	0.82	18.0	31.7	0.97/0.91	19%/18%	77%/78%	0.98/0.95	15%/16%	83%/84%
-CA083	0.83	17.8	31.3	0.97/0.91	19%/18%	77%/78%	0.98/0.95	15%/16%	83%/84%

* See How to Build a Model Number, K-Case Type page for a sample model number.

continued on next page...

 SPECIFICATION SUBMITTAL

Page

Job Name:	Model Numbers:
Job Number:	

K-Case Models: "C" Output Range (continued)

Output Current and Compatible Load Voltage (continued)

Model Number* LDE14U1UKS/N	Rated Output Current (A)	Compatible Load Voltage (V)		Typical Performance at Minimum Compatible Load Voltage			Typical Performance at Maximum Compatible Load Voltage		
		Minimum	Maximum	Power Factor @ 120 V/277 V	THD @ 120 V/277 V	Efficiency @ 120 V/277 V	Power Factor @ 120 V/277 V	THD @ 120 V/277 V	Efficiency @ 120 V/277 V
-CA084	0.84	17.6	31.0	0.97/0.91	19%/18%	77%/78%	0.98/0.95	15%/16%	83%/84%
-CA085	0.85	17.4	30.6	0.97/0.91	19%/18%	77%/78%	0.98/0.95	15%/16%	83%/84%
-CA086	0.86	17.2	30.2	0.97/0.91	19%/18%	77%/78%	0.98/0.95	15%/16%	83%/84%
-CA087	0.87	17.0	29.9	0.97/0.91	19%/18%	77%/77%	0.98/0.95	15%/16%	83%/84%
-CA088	0.88	16.8	29.5	0.97/0.91	19%/18%	77%/77%	0.98/0.95	15%/16%	82%/84%
-CA089	0.89	16.7	29.2	0.97/0.91	19%/18%	77%/77%	0.98/0.95	15%/16%	82%/84%
-CA090	0.90	16.5	28.9	0.97/0.91	19%/18%	77%/77%	0.98/0.95	15%/16%	82%/84%
-CA091	0.91	16.3	28.6	0.97/0.91	19%/18%	76%/77%	0.98/0.95	15%/16%	82%/84%
-CA092	0.92	16.2	28.3	0.97/0.91	19%/18%	76%/77%	0.98/0.95	15%/16%	82%/84%
-CA093	0.93	16.0	28.0	0.97/0.91	19%/18%	76%/77%	0.98/0.95	15%/16%	82%/83%

* See [How to Build a Model Number, K-Case Type](#) page for a sample model number.

Job Name:	Model Numbers:
Job Number:	

K-Case Models: "D" Output Range

Driver Type	Output Voltage	Output Current	Output Power	Standards Recognition	Maximum Rated Temp. @ t_c for Warranty
Constant Current Driver (Class 2)	12–30.2 V $\overline{\text{---}}$	0.38–0.75 A*	8–16 W		75 °C

* QwikFig compatible model number LDE14U1UKx-DABLK is configurable to any current within this range in 0.01 A increments. "x" in the model number is either "S" (Studded) or "N" (Non-Studded).

Typical Performance Specifications

Parameter	Value	Test Conditions
Input Current	0.09 A	$V_i = 277\text{ V}\sim$, $t_a = 25\text{ }^\circ\text{C}$, $I_o = 0.75\text{ A}$, $V_o = 21.3\text{ V}\overline{\text{---}}$, Maximum Light Output LDE14U1UKN-DA075
Power Factor	0.89	
THD	20%	
Driver Efficiency	77%	

Load Compatibility

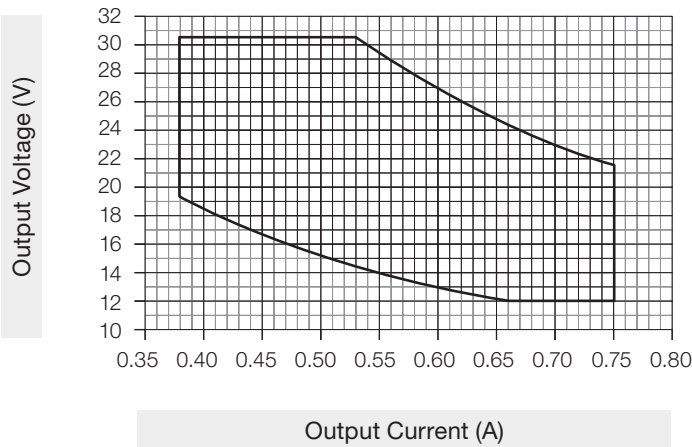

Typical Efficiency vs. Output Current

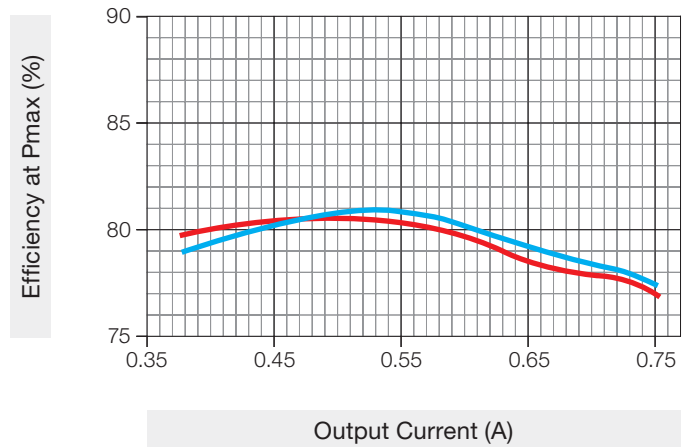

Key: — 120 V \sim — 277 V \sim

Typical THD vs. Output Power

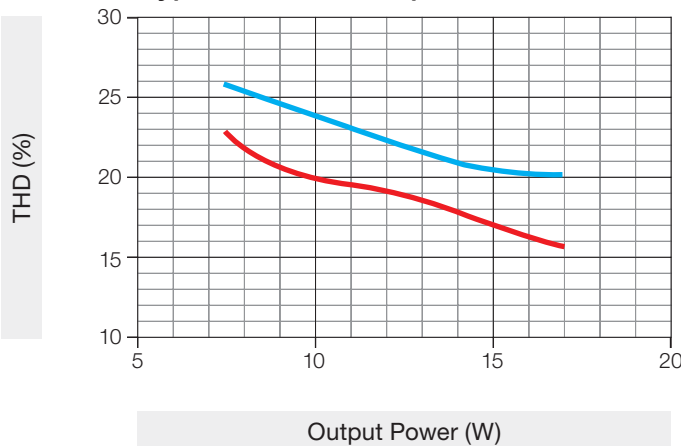

Key: — 120 V \sim — 277 V \sim

Typical Power Factor vs. Output Power

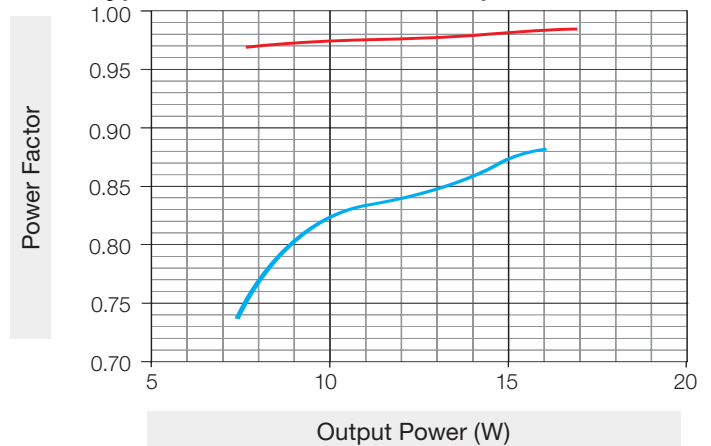

Key: — 120 V \sim — 277 V \sim

continued on next page...

Job Name:	Model Numbers:
Job Number:	

K-Case Models: "D" Output Range (continued)

Output Current and Compatible Load Voltage

Model Number* LDE14U1UKS/N	Rated Output Current (A)	Compatible Load Voltage (V)		Typical Performance at Minimum Compatible Load Voltage			Typical Performance at Maximum Compatible Load Voltage		
		Minimum	Maximum	Power Factor @ 120 V/277 V	THD @ 120 V/277 V	Efficiency @ 120 V/277 V	Power Factor @ 120 V/277 V	THD @ 120 V/277 V	Efficiency @ 120 V/277 V
-DA038	0.38	19.5	30.2	0.96/0.74	23%/26%	74%/72%	0.97/0.83	20%/23%	80%/79%
-DA039	0.39	19.1	30.2	0.96/0.74	23%/26%	74%/72%	0.97/0.84	19%/23%	80%/79%
-DA040	0.40	18.7	30.2	0.96/0.74	23%/26%	74%/72%	0.97/0.84	19%/23%	80%/79%
-DA041	0.41	18.4	30.2	0.96/0.74	23%/26%	74%/72%	0.97/0.84	19%/22%	80%/80%
-DA042	0.42	18.0	30.2	0.96/0.74	23%/26%	74%/72%	0.97/0.85	19%/22%	80%/80%
-DA043	0.43	17.7	30.2	0.96/0.75	23%/26%	73%/72%	0.97/0.85	19%/22%	80%/80%
-DA044	0.44	17.3	30.2	0.96/0.75	23%/26%	73%/72%	0.97/0.85	18%/22%	80%/80%
-DA045	0.45	17.0	30.2	0.96/0.75	23%/26%	73%/71%	0.97/0.86	18%/21%	80%/80%
-DA046	0.46	16.7	30.2	0.96/0.75	23%/26%	73%/71%	0.97/0.86	18%/21%	80%/80%
-DA047	0.47	16.4	30.2	0.96/0.75	23%/26%	73%/71%	0.97/0.86	18%/21%	81%/81%
-DA048	0.48	16.1	30.2	0.96/0.75	23%/26%	73%/71%	0.98/0.87	17%/21%	81%/81%
-DA049	0.49	15.8	30.2	0.96/0.75	23%/26%	72%/71%	0.98/0.87	17%/21%	81%/81%
-DA050	0.50	15.5	30.2	0.96/0.76	23%/26%	72%/71%	0.98/0.87	17%/21%	81%/81%
-DA051	0.51	15.2	30.2	0.96/0.76	22%/26%	72%/71%	0.98/0.87	17%/20%	81%/81%
-DA052	0.52	15.0	30.2	0.96/0.76	22%/25%	72%/71%	0.98/0.88	17%/20%	81%/81%
-DA053	0.53	14.7	30.2	0.96/0.76	22%/25%	72%/71%	0.98/0.88	16%/20%	81%/81%
-DA054	0.54	14.5	29.6	0.96/0.76	22%/25%	72%/71%	0.98/0.88	16%/20%	81%/81%
-DA055	0.55	14.2	29.1	0.96/0.77	22%/25%	72%/70%	0.98/0.88	16%/20%	81%/81%
-DA056	0.56	14.0	28.6	0.96/0.77	22%/25%	71%/70%	0.98/0.88	16%/20%	80%/81%
-DA057	0.57	13.8	28.1	0.96/0.77	22%/25%	71%/70%	0.98/0.88	16%/20%	80%/81%
-DA058	0.58	13.5	27.6	0.96/0.77	22%/25%	71%/70%	0.98/0.88	16%/20%	80%/80%
-DA059	0.59	13.3	27.1	0.96/0.77	22%/25%	71%/70%	0.98/0.88	16%/20%	80%/80%
-DA060	0.60	13.1	26.7	0.96/0.77	22%/25%	71%/70%	0.98/0.88	16%/20%	80%/80%
-DA061	0.61	12.9	26.2	0.96/0.77	22%/25%	71%/69%	0.98/0.88	16%/20%	80%/80%
-DA062	0.62	12.8	25.8	0.96/0.77	22%/25%	71%/69%	0.98/0.88	16%/20%	79%/80%
-DA063	0.63	12.6	25.4	0.96/0.77	22%/25%	70%/69%	0.98/0.88	16%/20%	79%/80%
-DA064	0.64	12.4	25.0	0.96/0.77	22%/25%	70%/69%	0.98/0.88	16%/20%	79%/79%
-DA065	0.65	12.2	24.6	0.96/0.77	22%/25%	70%/69%	0.98/0.88	16%/20%	79%/79%
-DA066	0.66	12.1	24.2	0.96/0.78	22%/25%	70%/69%	0.98/0.88	16%/20%	79%/79%
-DA067	0.67	12.0	23.9	0.96/0.78	22%/25%	70%/69%	0.98/0.88	16%/20%	79%/79%
-DA068	0.68	12.0	23.5	0.96/0.78	22%/25%	70%/69%	0.98/0.88	16%/20%	78%/79%
-DA069	0.69	12.0	23.2	0.96/0.78	22%/25%	70%/69%	0.98/0.88	16%/20%	78%/79%
-DA070	0.70	12.0	22.9	0.96/0.79	22%/25%	70%/68%	0.98/0.88	16%/20%	78%/79%
-DA071	0.71	12.0	22.5	0.97/0.79	21%/25%	70%/68%	0.98/0.88	16%/20%	78%/78%
-DA072	0.72	12.0	22.2	0.97/0.79	21%/25%	69%/68%	0.98/0.89	16%/20%	78%/78%
-DA073	0.73	12.0	21.9	0.97/0.79	21%/25%	69%/68%	0.98/0.89	16%/20%	78%/78%
-DA074	0.74	12.0	21.6	0.97/0.80	21%/25%	69%/68%	0.98/0.89	16%/20%	77%/78%
-DA075	0.75	12.0	21.3	0.97/0.82	21%/25%	69%/68%	0.98/0.89	16%/20%	77%/78%

* See How to Build a Model Number, K-Case Type page for a sample model number.

Job Name:	Model Numbers:
Job Number:	

K-Case Models: "E" Output Range

Driver Type	Output Voltage	Output Current	Output Power	Standards Recognition	Maximum Rated Temp. @ t_c for Warranty
Constant Current Driver (Class 2)	31 – 50 V \sim	0.71 – 1.05 A*	22 – 40 W	 US LISTED CLASS P E322469	75 °C

* QwikFig compatible model number LDE14U1UKx-EABLK is configurable to any current within this range in 0.01 A increments. "x" in the model number is either "S" (Studded) or "N" (Non-Studded).

Typical Performance Specifications

Parameter	Value	Test Conditions
Input Current	0.17 A	$V_i = 277\text{ V}\sim$, $t_a = 25\text{ }^\circ\text{C}$, $I_o = 1.05\text{ A}$, $V_o = 38.1\text{ V}\sim$, Maximum Light Output LDE14U1UKN-EA105
Power Factor	0.96	
THD	17%	
Driver Efficiency	87%	

Load Compatibility

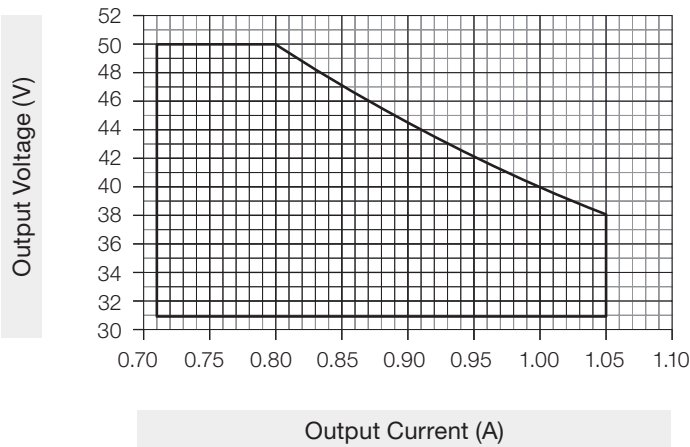

Typical Efficiency vs. Output Current

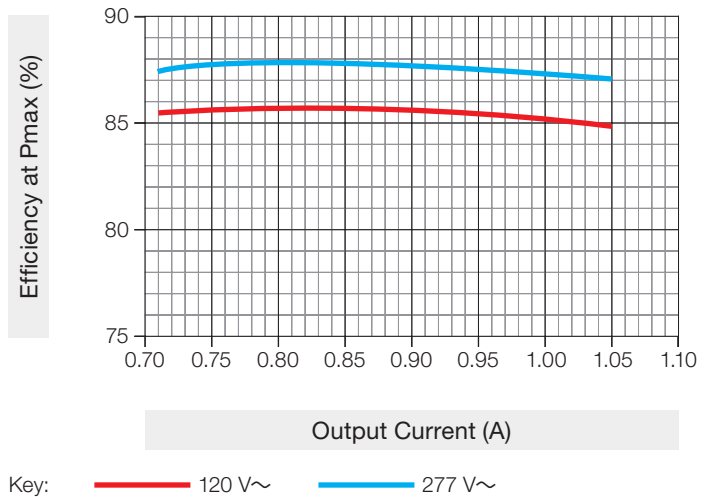

Typical THD vs. Output Power

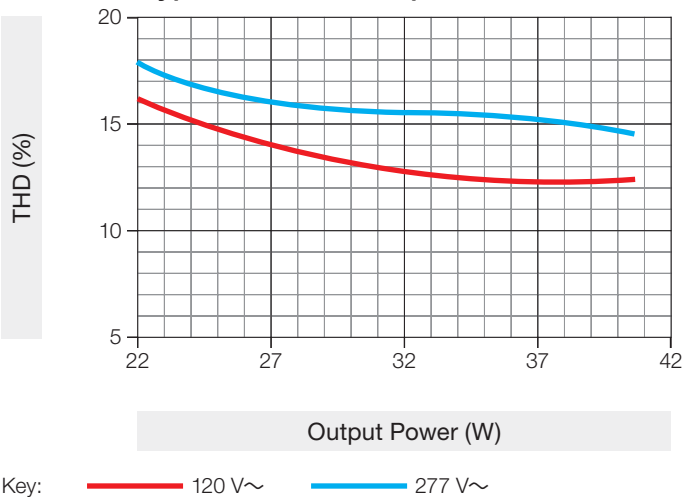

Typical Power Factor vs. Output Power

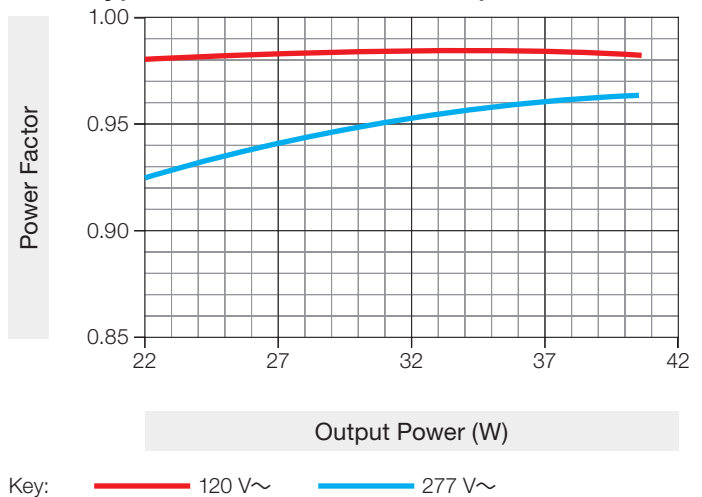

continued on next page...

Job Name:	Model Numbers:
Job Number:	

K-Case Models: "E" Output Range (continued)

Output Current and Compatible Load Voltage

Model Number* LDE14U1UKS/N	Rated Output Current (A)	Compatible Load Voltage (V)		Typical Performance at Minimum Compatible Load Voltage			Typical Performance at Maximum Compatible Load Voltage		
		Minimum	Maximum	Power Factor @ 120 V/277 V	THD @ 120 V/277 V	Efficiency @ 120 V/277 V	Power Factor @ 120 V/277 V	THD @ 120 V/277 V	Efficiency @ 120 V/277 V
-EA071	0.71	31.0	50.0	0.98/0.93	16%/18%	82%/83%	0.98/0.96	13%/15%	85%/87%
-EA072	0.72	31.0	50.0	0.98/0.93	16%/18%	82%/83%	0.98/0.96	13%/15%	85%/87%
-EA073	0.73	31.0	50.0	0.98/0.93	16%/18%	82%/83%	0.98/0.96	13%/15%	85%/87%
-EA074	0.74	31.0	50.0	0.98/0.93	16%/18%	83%/84%	0.98/0.96	12%/15%	85%/87%
-EA075	0.75	31.0	50.0	0.98/0.93	16%/18%	83%/84%	0.98/0.96	12%/15%	85%/87%
-EA076	0.76	31.0	50.0	0.98/0.93	16%/17%	83%/84%	0.98/0.96	12%/15%	85%/87%
-EA077	0.77	31.0	50.0	0.98/0.93	15%/17%	83%/84%	0.98/0.96	12%/15%	86%/88%
-EA078	0.78	31.0	50.0	0.98/0.93	15%/17%	83%/84%	0.98/0.96	12%/15%	86%/88%
-EA079	0.79	31.0	50.0	0.98/0.93	15%/17%	83%/84%	0.98/0.96	12%/15%	86%/88%
-EA080	0.80	31.0	50.0	0.98/0.93	15%/17%	83%/84%	0.98/0.96	12%/15%	86%/88%
-EA081	0.81	31.0	49.4	0.98/0.94	15%/17%	83%/84%	0.98/0.96	12%/15%	86%/88%
-EA082	0.82	31.0	48.8	0.98/0.94	15%/17%	83%/84%	0.98/0.96	12%/15%	86%/88%
-EA083	0.83	31.0	48.2	0.98/0.94	15%/16%	83%/84%	0.98/0.96	12%/15%	86%/88%
-EA084	0.84	31.0	47.6	0.98/0.94	15%/16%	83%/85%	0.98/0.96	12%/15%	86%/88%
-EA085	0.85	31.0	47.1	0.98/0.94	15%/16%	83%/85%	0.98/0.96	12%/15%	86%/88%
-EA086	0.86	31.0	46.5	0.98/0.94	14%/16%	83%/85%	0.98/0.96	12%/15%	86%/88%
-EA087	0.87	31.0	46.0	0.98/0.94	14%/16%	83%/85%	0.98/0.96	12%/15%	86%/88%
-EA088	0.88	31.0	45.5	0.98/0.94	14%/16%	83%/85%	0.98/0.96	12%/15%	86%/88%
-EA089	0.89	31.0	44.9	0.98/0.94	14%/16%	84%/85%	0.98/0.96	12%/15%	86%/88%
-EA090	0.90	31.0	44.4	0.98/0.94	14%/16%	84%/85%	0.98/0.96	12%/15%	86%/88%
-EA091	0.91	31.0	44.0	0.98/0.94	14%/16%	84%/85%	0.98/0.96	12%/15%	86%/88%
-EA092	0.92	31.0	43.5	0.98/0.94	14%/16%	84%/85%	0.98/0.96	12%/15%	85%/88%
-EA093	0.93	31.0	43.0	0.98/0.94	14%/16%	84%/85%	0.98/0.96	12%/15%	85%/88%
-EA094	0.94	31.0	42.6	0.98/0.95	14%/16%	84%/85%	0.98/0.96	12%/15%	85%/88%
-EA095	0.95	31.0	42.1	0.98/0.95	14%/16%	84%/85%	0.98/0.96	12%/15%	85%/87%
-EA096	0.96	31.0	41.7	0.98/0.95	13%/16%	84%/85%	0.98/0.96	12%/15%	85%/87%
-EA097	0.97	31.0	41.2	0.98/0.95	13%/16%	84%/85%	0.98/0.96	12%/15%	85%/87%
-EA098	0.98	31.0	40.8	0.98/0.95	13%/16%	84%/85%	0.98/0.96	12%/15%	85%/87%
-EA099	0.99	31.0	40.4	0.98/0.95	13%/16%	84%/85%	0.98/0.96	12%/15%	85%/87%
-EA100	1.00	31.0	40.0	0.98/0.95	13%/16%	84%/85%	0.98/0.96	12%/15%	85%/87%
-EA101	1.01	31.0	39.6	0.98/0.95	13%/16%	84%/85%	0.98/0.96	12%/15%	85%/87%
-EA102	1.02	31.0	39.2	0.98/0.95	13%/16%	84%/85%	0.98/0.96	12%/15%	85%/87%
-EA103	1.03	31.0	38.8	0.98/0.95	13%/16%	84%/85%	0.98/0.96	12%/15%	85%/87%
-EA104	1.04	31.0	38.5	0.98/0.95	13%/16%	84%/85%	0.98/0.96	12%/15%	85%/87%
-EA105	1.05	31.0	38.1	0.98/0.95	13%/16%	84%/85%	0.98/0.96	12%/15%	85%/87%

* See [How to Build a Model Number, K-Case Type](#) page for a sample model number.

Job Name:	Model Numbers:
Job Number:	

K-Case Models: "F" Output Range

Driver Type	Output Voltage	Output Current	Output Power	Standards Recognition	Maximum Rated Temp. @ t_c for Warranty
Constant Current Driver (Class 2)	19–38 V \sim	0.71–1.4 A*	21–40 W	US LISTED CLASS P E322469	75 °C

* QwikFig compatible model number LDE14U1UKx-FABLK is configurable to any current within this range in 0.01 A increments. "x" in the model number is either "S" (Studded) or "N" (Non-Studded).

Typical Performance Specifications

Parameter	Value	Test Conditions
Input Current	0.17 A	$V_i = 277\text{ V}\sim$, $t_a = 25\text{ }^\circ\text{C}$, $I_o = 1.4\text{ A}$, $V_o = 28.6\text{ V}\sim$, Maximum Light Output LDE14U1UKN-FA140
Power Factor	0.96	
THD	18%	
Driver Efficiency	86%	

Load Compatibility

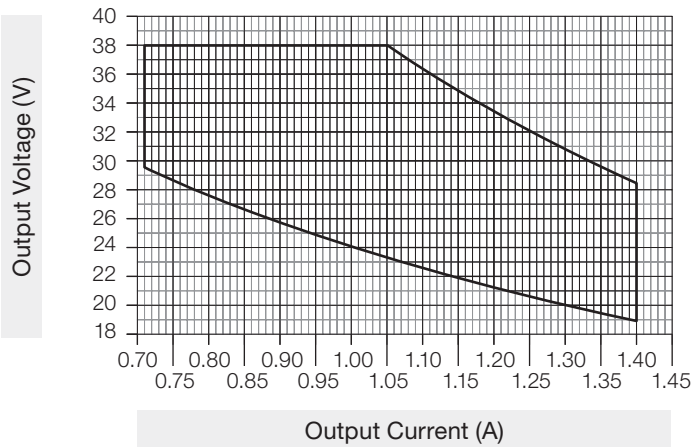

Typical Efficiency vs. Output Current

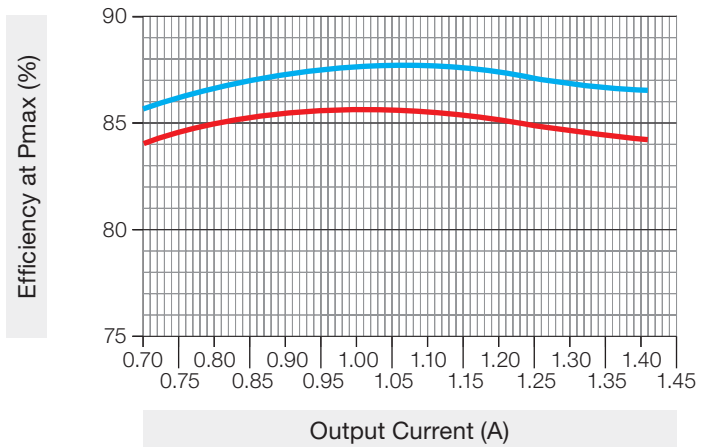

Key: — 120 V \sim — 277 V \sim

Typical THD vs. Output Power

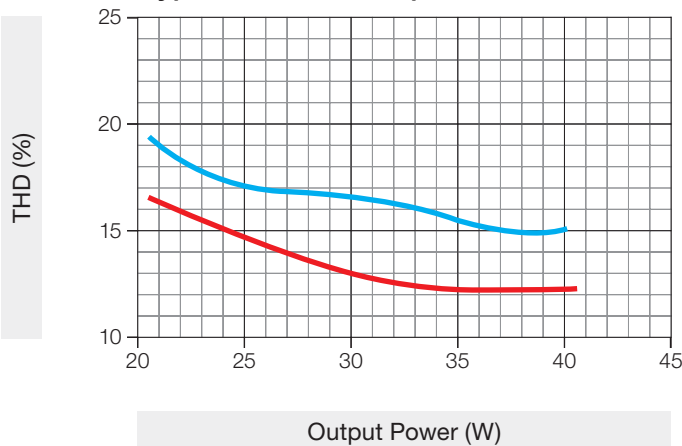

Key: — 120 V \sim — 277 V \sim

Typical Power Factor vs. Output Power

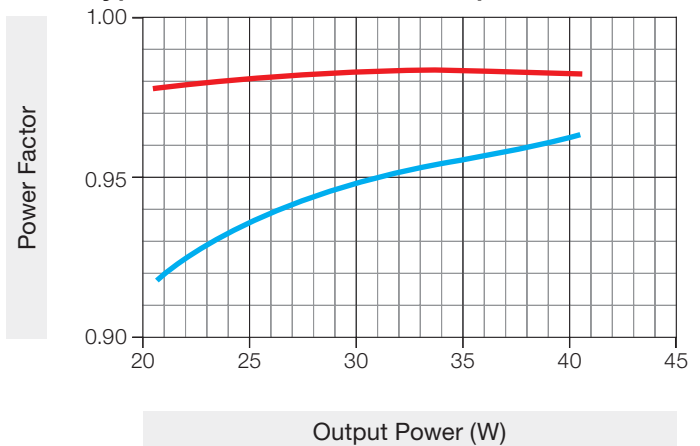

Key: — 120 V \sim — 277 V \sim

continued on next page...

Job Name:	Model Numbers:
Job Number:	

K-Case Models: "F" Output Range (continued)

Output Current and Compatible Load Voltage

Model Number* LDE14U1UKS/N	Rated Output Current (A)	Compatible Load Voltage (V)		Typical Performance at Minimum Compatible Load Voltage			Typical Performance at Maximum Compatible Load Voltage		
		Minimum	Maximum	Power Factor @ 120 V/277 V	THD @ 120 V/277 V	Efficiency @ 120 V/277 V	Power Factor @ 120 V/277 V	THD @ 120 V/277 V	Efficiency @ 120 V/277 V
-FA071	0.71	29.5	38.0	0.98/0.93	17%/19%	82%/84%	0.98/0.94	14%/17%	84%/86%
-FA072	0.72	29.3	38.0	0.98/0.93	17%/19%	82%/84%	0.98/0.94	14%/17%	84%/86%
-FA073	0.73	29.1	38.0	0.98/0.93	17%/19%	82%/84%	0.98/0.94	14%/17%	84%/86%
-FA074	0.74	28.9	38.0	0.98/0.93	17%/19%	82%/84%	0.98/0.94	14%/17%	84%/86%
-FA075	0.75	28.7	38.0	0.98/0.93	16%/19%	82%/84%	0.98/0.94	13%/17%	84%/86%
-FA076	0.76	28.5	38.0	0.98/0.93	16%/19%	82%/84%	0.98/0.94	13%/17%	84%/86%
-FA077	0.77	28.3	38.0	0.98/0.93	16%/19%	83%/84%	0.98/0.95	13%/17%	84%/86%
-FA078	0.78	28.1	38.0	0.98/0.93	16%/18%	83%/84%	0.98/0.95	13%/17%	84%/86%
-FA079	0.79	27.9	38.0	0.98/0.93	16%/18%	83%/84%	0.98/0.95	13%/17%	84%/86%
-FA080	0.80	27.7	38.0	0.98/0.93	16%/18%	83%/84%	0.98/0.95	13%/17%	85%/87%
-FA081	0.81	27.5	38.0	0.98/0.93	16%/18%	83%/84%	0.98/0.95	13%/16%	85%/87%
-FA082	0.82	27.3	38.0	0.98/0.93	16%/18%	83%/84%	0.98/0.95	13%/16%	85%/87%
-FA083	0.83	27.1	38.0	0.98/0.93	16%/18%	83%/84%	0.98/0.95	13%/16%	85%/87%
-FA084	0.84	27.0	38.0	0.98/0.93	16%/18%	83%/84%	0.98/0.95	12%/16%	85%/87%
-FA085	0.85	26.8	38.0	0.98/0.93	16%/18%	83%/84%	0.98/0.95	12%/16%	85%/87%
-FA086	0.86	26.6	38.0	0.98/0.93	16%/18%	83%/84%	0.98/0.95	12%/16%	85%/87%
-FA087	0.87	26.4	38.0	0.98/0.93	16%/18%	83%/84%	0.98/0.95	12%/16%	85%/87%
-FA088	0.88	26.2	38.0	0.98/0.93	16%/18%	83%/84%	0.98/0.95	12%/16%	85%/87%
-FA089	0.89	26.0	38.0	0.98/0.93	16%/18%	83%/84%	0.98/0.95	12%/16%	85%/87%
-FA090	0.90	25.9	38.0	0.98/0.93	16%/18%	83%/84%	0.98/0.95	12%/16%	85%/87%
-FA091	0.91	25.7	38.0	0.98/0.93	15%/18%	83%/84%	0.98/0.95	12%/16%	85%/87%
-FA092	0.92	25.5	38.0	0.98/0.93	15%/18%	83%/84%	0.98/0.95	12%/15%	85%/87%
-FA093	0.93	25.3	38.0	0.98/0.93	15%/18%	83%/84%	0.98/0.95	12%/15%	85%/87%
-FA094	0.94	25.2	38.0	0.98/0.93	15%/18%	83%/84%	0.98/0.95	12%/15%	85%/87%
-FA095	0.95	25.0	38.0	0.98/0.93	15%/18%	83%/84%	0.98/0.96	12%/15%	85%/87%
-FA096	0.96	24.8	38.0	0.98/0.93	15%/18%	83%/84%	0.98/0.96	12%/15%	85%/87%
-FA097	0.97	24.7	38.0	0.98/0.93	15%/17%	83%/84%	0.98/0.96	12%/15%	85%/87%
-FA098	0.98	24.5	38.0	0.98/0.93	15%/17%	83%/84%	0.98/0.96	12%/15%	85%/87%
-FA099	0.99	24.3	38.0	0.98/0.93	15%/17%	83%/84%	0.98/0.96	12%/15%	85%/87%
-FA100	1.00	24.2	38.0	0.98/0.93	15%/17%	83%/84%	0.98/0.96	12%/15%	85%/87%
-FA101	1.01	24.0	38.0	0.98/0.93	15%/17%	83%/84%	0.98/0.96	12%/15%	85%/87%
-FA102	1.02	23.9	38.0	0.98/0.93	15%/17%	83%/84%	0.98/0.96	12%/15%	85%/87%
-FA103	1.03	23.7	38.0	0.98/0.93	15%/17%	83%/84%	0.98/0.96	12%/15%	85%/88%
-FA104	1.04	23.5	38.0	0.98/0.94	15%/17%	83%/84%	0.98/0.96	12%/15%	85%/88%
-FA105	1.05	23.4	38.0	0.98/0.94	15%/17%	83%/84%	0.98/0.96	12%/15%	85%/88%
-FA106	1.06	23.2	37.7	0.98/0.94	15%/17%	83%/84%	0.98/0.96	12%/15%	85%/88%
-FA107	1.07	23.1	37.4	0.98/0.94	15%/17%	83%/84%	0.98/0.96	12%/15%	85%/88%
-FA108	1.08	22.9	37.0	0.98/0.94	15%/17%	83%/84%	0.98/0.96	12%/15%	85%/88%

* See How to Build a Model Number, K-Case Type page for a sample model number.

continued on next page...

 SPECIFICATION SUBMITTAL

Page

Job Name:	Model Numbers:
Job Number:	

K-Case Models: "F" Output Range (continued)

Output Current and Compatible Load Voltage (continued)

Model Number* LDE14U1UKS/N	Rated Output Current (A)	Compatible Load Voltage (V)		Typical Performance at Minimum Compatible Load Voltage			Typical Performance at Maximum Compatible Load Voltage		
		Minimum	Maximum	Power Factor @ 120 V/277 V	THD @ 120 V/277 V	Efficiency @ 120 V/277 V	Power Factor @ 120 V/277 V	THD @ 120 V/277 V	Efficiency @ 120 V/277 V
-FA109	1.09	22.8	36.7	0.98/0.94	15%/17%	83%/84%	0.98/0.96	12%/15%	85%/87%
-FA110	1.10	22.6	36.4	0.98/0.94	15%/17%	83%/84%	0.98/0.96	12%/15%	85%/87%
-FA111	1.11	22.5	36.0	0.98/0.94	15%/17%	83%/84%	0.98/0.96	12%/15%	85%/87%
-FA112	1.12	22.4	35.7	0.98/0.94	15%/17%	83%/84%	0.98/0.96	12%/15%	85%/87%
-FA113	1.13	22.2	35.4	0.98/0.94	15%/17%	83%/84%	0.98/0.96	12%/15%	85%/87%
-FA114	1.14	22.1	35.1	0.98/0.94	15%/17%	83%/84%	0.98/0.96	12%/15%	85%/87%
-FA115	1.15	21.9	34.8	0.98/0.94	15%/17%	83%/84%	0.98/0.96	12%/15%	85%/87%
-FA116	1.16	21.8	34.5	0.98/0.94	15%/17%	83%/84%	0.98/0.96	12%/15%	85%/87%
-FA117	1.17	21.7	34.2	0.98/0.94	15%/17%	83%/84%	0.98/0.96	12%/15%	85%/87%
-FA118	1.18	21.5	33.9	0.98/0.94	15%/17%	83%/84%	0.98/0.96	12%/15%	85%/87%
-FA119	1.19	21.4	33.6	0.98/0.94	15%/17%	83%/84%	0.98/0.96	12%/15%	85%/87%
-FA120	1.20	21.3	33.3	0.98/0.94	15%/17%	83%/84%	0.98/0.96	12%/15%	85%/87%
-FA121	1.21	21.1	33.1	0.98/0.94	15%/17%	83%/84%	0.98/0.96	12%/15%	85%/87%
-FA122	1.22	21.0	32.8	0.98/0.94	15%/17%	83%/84%	0.98/0.96	12%/15%	85%/87%
-FA123	1.23	20.9	32.5	0.98/0.94	14%/17%	82%/84%	0.98/0.96	12%/15%	85%/87%
-FA124	1.24	20.8	32.3	0.98/0.94	14%/17%	82%/84%	0.98/0.96	12%/15%	85%/87%
-FA125	1.25	20.6	32.0	0.98/0.94	14%/17%	82%/84%	0.98/0.96	12%/15%	85%/87%
-FA126	1.26	20.5	31.7	0.98/0.94	14%/17%	82%/84%	0.98/0.96	12%/15%	85%/87%
-FA127	1.27	20.4	31.5	0.98/0.94	14%/17%	82%/84%	0.98/0.96	12%/15%	85%/87%
-FA128	1.28	20.3	31.3	0.98/0.94	14%/17%	82%/84%	0.98/0.96	12%/15%	85%/87%
-FA129	1.29	20.2	31.0	0.98/0.94	14%/17%	82%/84%	0.98/0.96	12%/15%	85%/87%
-FA130	1.30	20.1	30.8	0.98/0.94	14%/17%	82%/84%	0.98/0.96	12%/15%	84%/87%
-FA131	1.31	19.9	30.5	0.98/0.94	14%/17%	82%/84%	0.98/0.96	12%/15%	84%/87%
-FA132	1.32	19.8	30.3	0.98/0.94	14%/17%	82%/84%	0.98/0.96	12%/15%	84%/87%
-FA133	1.33	19.7	30.1	0.98/0.94	14%/17%	82%/84%	0.98/0.96	12%/15%	84%/87%
-FA134	1.34	19.6	29.9	0.98/0.94	14%/17%	82%/83%	0.98/0.96	12%/15%	84%/87%
-FA135	1.35	19.5	29.6	0.98/0.94	14%/17%	82%/83%	0.98/0.96	12%/15%	84%/86%
-FA136	1.36	19.4	29.4	0.98/0.94	14%/17%	82%/83%	0.98/0.96	12%/15%	84%/86%
-FA137	1.37	19.3	29.2	0.98/0.94	14%/17%	82%/83%	0.98/0.96	12%/15%	84%/86%
-FA138	1.38	19.2	29.0	0.98/0.94	14%/17%	82%/83%	0.98/0.96	12%/15%	84%/86%
-FA139	1.39	19.1	28.8	0.98/0.94	14%/17%	82%/83%	0.98/0.96	12%/15%	84%/86%
-FA140	1.40	19.0	28.6	0.98/0.94	14%/17%	82%/83%	0.98/0.96	12%/15%	84%/86%

* See [How to Build a Model Number, K-Case Type](#) page for a sample model number.

Job Name:	Model Numbers:
Job Number:	

K-Case Models: "G" Output Range

Driver Type	Output Voltage	Output Current	Output Power	Standards Recognition	Maximum Rated Temp. @ t_c for Warranty
Constant Current Driver (Class 2)	13–30 V $\overline{=}$	0.94–1.4 A*	18.5–32 W	 US LISTED CLASS P E322469	75 °C

* QwikFig compatible model number LDE14U1UKx-GABLK is configurable to any current within this range in 0.01 A increments. "x" in the model number is either "S" (Studded) or "N" (Non-Studded).

Typical Performance Specifications

Parameter	Value	Test Conditions
Input Current	0.14 A	$V_i = 277\text{ V}\sim$, $t_a = 25\text{ }^\circ\text{C}$, $I_o = 1.4\text{ A}$, $V_o = 22.9\text{ V}\overline{=}$, Maximum Light Output LDE14U1UKN-GA140
Power Factor	0.96	
THD	18%	
Driver Efficiency	84%	

Load Compatibility

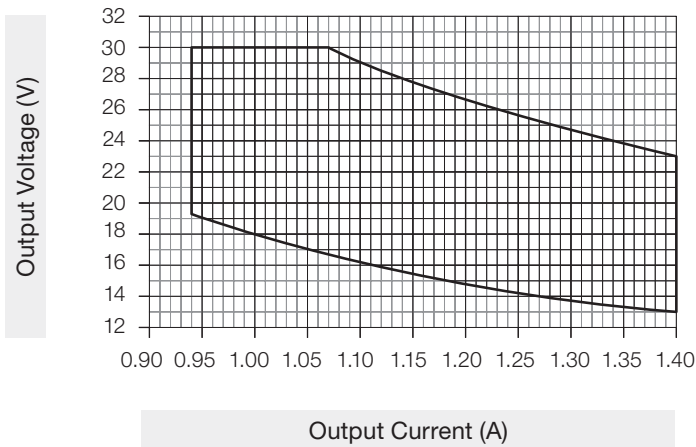

Typical Efficiency vs. Output Current

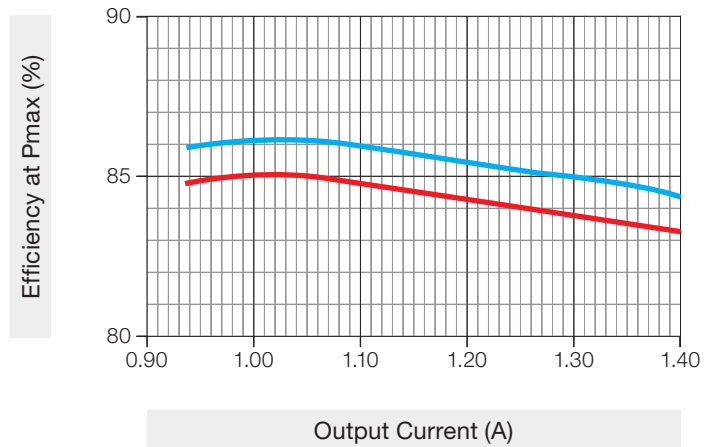

Key: — 120 V \sim — 277 V \sim

Typical THD vs. Output Power

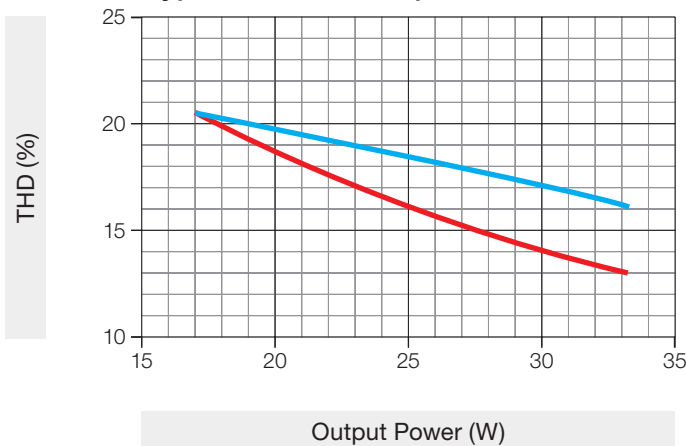

Key: — 120 V \sim — 277 V \sim

Typical Power Factor vs. Output Power

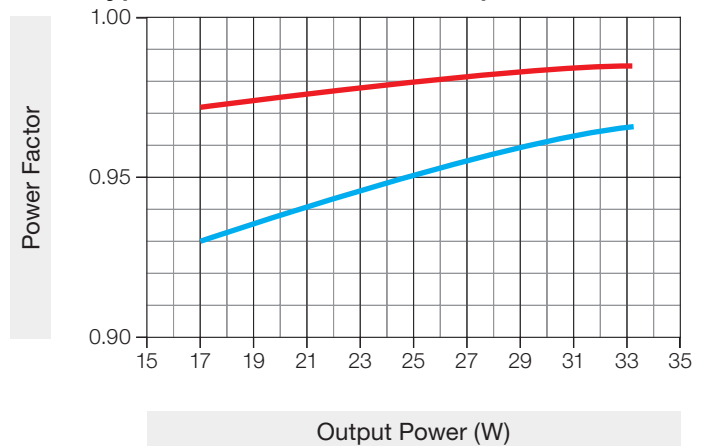

Key: — 120 V \sim — 277 V \sim

continued on next page...

Job Name:	Model Numbers:
Job Number:	

K-Case Models: “G” Output Range (continued)

Output Current and Compatible Load Voltage

Model Number* LDE14U1UKS/N	Rated Output Current (A)	Compatible Load Voltage (V)		Typical Performance at Minimum Compatible Load Voltage			Typical Performance at Maximum Compatible Load Voltage		
		Minimum	Maximum	Power Factor @ 120 V/277 V	THD @ 120 V/277 V	Efficiency @ 120 V/277 V	Power Factor @ 120 V/277 V	THD @ 120 V/277 V	Efficiency @ 120 V/277 V
-GA094	0.94	19.4	30.0	0.97/0.93	20%/20%	81%/82%	0.98/0.96	18%/18%	85%/86%
-GA095	0.95	19.2	30.0	0.97/0.93	20%/20%	81%/81%	0.98/0.96	18%/18%	85%/86%
-GA096	0.96	19.0	30.0	0.97/0.93	20%/20%	81%/81%	0.98/0.96	18%/18%	85%/86%
-GA097	0.97	18.8	30.0	0.97/0.93	20%/20%	81%/81%	0.98/0.96	18%/18%	85%/86%
-GA098	0.98	18.6	30.0	0.97/0.93	20%/20%	81%/81%	0.98/0.96	18%/17%	85%/86%
-GA099	0.99	18.4	30.0	0.97/0.93	20%/20%	80%/81%	0.98/0.96	18%/17%	85%/86%
-GA100	1.00	18.2	30.0	0.97/0.93	20%/20%	80%/81%	0.98/0.96	17%/17%	85%/86%
-GA101	1.01	18.0	30.0	0.97/0.93	20%/20%	80%/81%	0.98/0.96	17%/17%	85%/86%
-GA102	1.02	17.8	30.0	0.97/0.93	20%/20%	80%/81%	0.98/0.96	17%/17%	85%/86%
-GA103	1.03	17.7	30.0	0.97/0.93	20%/20%	80%/81%	0.98/0.96	17%/17%	85%/86%
-GA104	1.04	17.5	30.0	0.97/0.93	20%/20%	80%/81%	0.98/0.96	17%/17%	85%/86%
-GA105	1.05	17.3	30.0	0.97/0.93	20%/20%	80%/81%	0.98/0.96	17%/17%	85%/86%
-GA106	1.06	17.2	30.0	0.97/0.93	20%/20%	80%/81%	0.98/0.96	17%/17%	85%/86%
-GA107	1.07	17.0	30.0	0.97/0.93	20%/20%	80%/81%	0.98/0.96	17%/17%	85%/86%
-GA108	1.08	16.9	29.6	0.97/0.93	20%/20%	80%/81%	0.98/0.96	17%/17%	85%/86%
-GA109	1.09	16.7	29.4	0.97/0.93	20%/20%	80%/81%	0.98/0.96	17%/17%	85%/86%
-GA110	1.10	16.5	29.1	0.97/0.93	20%/20%	80%/81%	0.98/0.96	17%/17%	85%/86%
-GA111	1.11	16.4	28.8	0.97/0.93	20%/20%	80%/81%	0.98/0.96	17%/17%	85%/86%
-GA112	1.12	16.3	28.6	0.97/0.93	20%/20%	80%/80%	0.98/0.96	17%/17%	84%/86%
-GA113	1.13	16.1	28.3	0.97/0.93	20%/20%	80%/80%	0.98/0.96	17%/17%	84%/86%
-GA114	1.14	16.0	28.1	0.97/0.93	20%/20%	80%/80%	0.98/0.96	17%/17%	84%/86%
-GA115	1.15	15.8	27.8	0.97/0.93	20%/20%	79%/80%	0.98/0.96	17%/17%	84%/86%
-GA116	1.16	15.7	27.6	0.97/0.93	20%/20%	79%/80%	0.98/0.96	17%/17%	84%/86%
-GA117	1.17	15.6	27.4	0.97/0.93	20%/20%	79%/80%	0.98/0.96	17%/17%	84%/86%
-GA118	1.18	15.4	27.1	0.97/0.93	20%/20%	79%/80%	0.98/0.96	17%/17%	84%/86%
-GA119	1.19	15.3	26.9	0.97/0.93	20%/20%	79%/80%	0.98/0.96	17%/17%	84%/86%
-GA120	1.20	15.2	26.7	0.97/0.93	20%/20%	79%/80%	0.98/0.96	17%/17%	84%/86%
-GA121	1.21	15.0	26.4	0.97/0.93	20%/20%	79%/80%	0.98/0.96	17%/17%	84%/85%
-GA122	1.22	14.9	26.2	0.97/0.93	20%/20%	79%/79%	0.98/0.96	17%/17%	84%/85%
-GA123	1.23	14.8	26.0	0.97/0.93	20%/20%	79%/79%	0.98/0.96	17%/17%	84%/85%
-GA124	1.24	14.7	25.8	0.97/0.93	20%/20%	79%/79%	0.98/0.96	17%/17%	84%/85%
-GA125	1.25	14.6	25.6	0.97/0.93	20%/20%	79%/79%	0.98/0.96	17%/17%	84%/85%
-GA126	1.26	14.4	25.4	0.97/0.93	20%/20%	79%/79%	0.98/0.96	17%/17%	84%/85%
-GA127	1.27	14.3	25.2	0.97/0.93	20%/20%	78%/79%	0.98/0.96	17%/17%	84%/85%
-GA128	1.28	14.2	25.0	0.97/0.93	20%/20%	78%/79%	0.98/0.96	17%/17%	84%/85%
-GA129	1.29	14.1	24.8	0.97/0.93	20%/20%	78%/79%	0.98/0.96	17%/17%	84%/85%
-GA130	1.30	14.0	24.6	0.97/0.93	20%/20%	78%/79%	0.98/0.96	17%/17%	84%/85%
-GA131	1.31	13.9	24.4	0.97/0.93	20%/20%	78%/79%	0.98/0.96	17%/17%	84%/85%

* See How to Build a Model Number, K-Case Type page for a sample model number.

continued on next page...

Job Name:	Model Numbers:
Job Number:	

K-Case Models: "G" Output Range (continued)

Output Current and Compatible Load Voltage (continued)

Model Number* LDE14U1UKS/N	Rated Output Current (A)	Compatible Load Voltage (V)		Typical Performance at Minimum Compatible Load Voltage			Typical Performance at Maximum Compatible Load Voltage		
		Minimum	Maximum	Power Factor @ 120 V/277 V	THD @ 120 V/277 V	Efficiency @ 120 V/277 V	Power Factor @ 120 V/277 V	THD @ 120 V/277 V	Efficiency @ 120 V/277 V
-GA132	1.32	13.8	24.2	0.97/0.93	20%/20%	78%/79%	0.98/0.96	17%/17%	83%/85%
-GA133	1.33	13.7	24.1	0.97/0.93	20%/20%	78%/79%	0.98/0.96	17%/17%	83%/85%
-GA134	1.34	13.6	23.9	0.97/0.93	20%/20%	78%/79%	0.98/0.96	17%/17%	83%/85%
-GA135	1.35	13.5	23.7	0.97/0.93	20%/20%	78%/79%	0.98/0.96	17%/17%	83%/85%
-GA136	1.36	13.4	23.5	0.97/0.93	20%/20%	78%/79%	0.98/0.96	17%/17%	83%/85%
-GA137	1.37	13.3	23.4	0.97/0.93	20%/20%	78%/79%	0.98/0.96	17%/17%	83%/85%
-GA138	1.38	13.2	23.2	0.97/0.93	20%/20%	78%/79%	0.98/0.96	17%/17%	83%/84%
-GA139	1.39	13.1	23.0	0.97/0.93	20%/20%	78%/79%	0.98/0.96	17%/17%	83%/84%
-GA140	1.40	13.0	22.9	0.97/0.93	20%/20%	78%/79%	0.98/0.96	17%/17%	83%/84%

* See [How to Build a Model Number, K-Case Type](#) page for a sample model number.

Job Name:	Model Numbers:
Job Number:	

K-Case Models: "H" Output Range

Driver Type	Output Voltage	Output Current	Output Power	Standards Recognition	Maximum Rated Temp. @ t_c for Warranty
Constant Current Driver (Class 2)	10–21 V \sim	0.63–1.05 A*	8–18 W	US LISTED CLASS P E322469	75 °C

* QwikFig compatible model number LDE14U1UKx-HABLK is configurable to any current within this range in 0.01 A increments. "x" in the model number is either "S" (Studded) or "N" (Non-Studded).

Typical Performance Specifications

Parameter	Value	Test Conditions
Input Current	0.09 A	$V_i = 277\text{ V}\sim$, $t_a = 25\text{ }^\circ\text{C}$, $I_o = 1.05\text{ A}$, $V_o = 17\text{ V}\sim$, Maximum Light Output LDE14U1UKN-HA105
Power Factor	0.92	
THD	17%	
Driver Efficiency	79%	

Load Compatibility

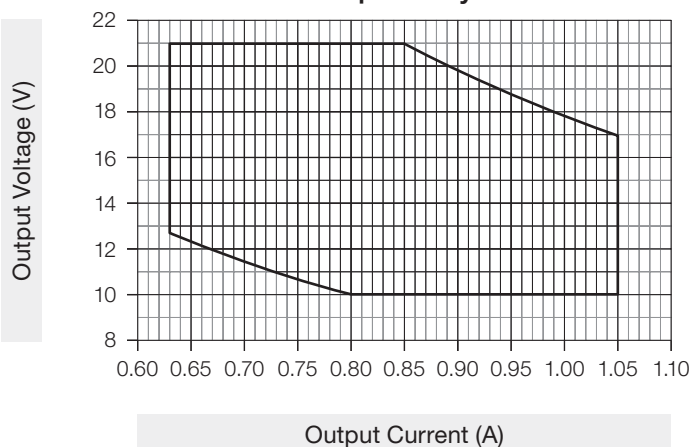

Typical Efficiency vs. Output Current

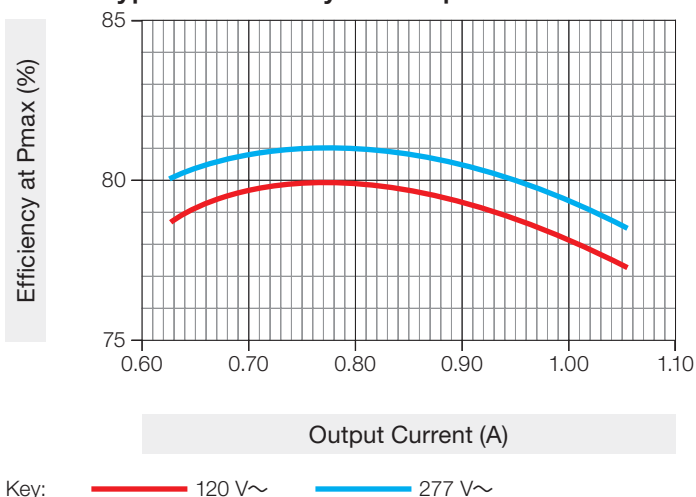

Typical THD vs. Output Power

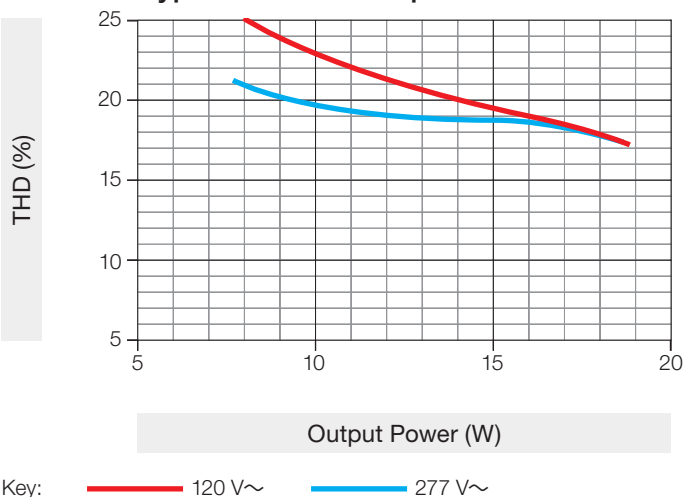

Typical Power Factor vs. Output Power

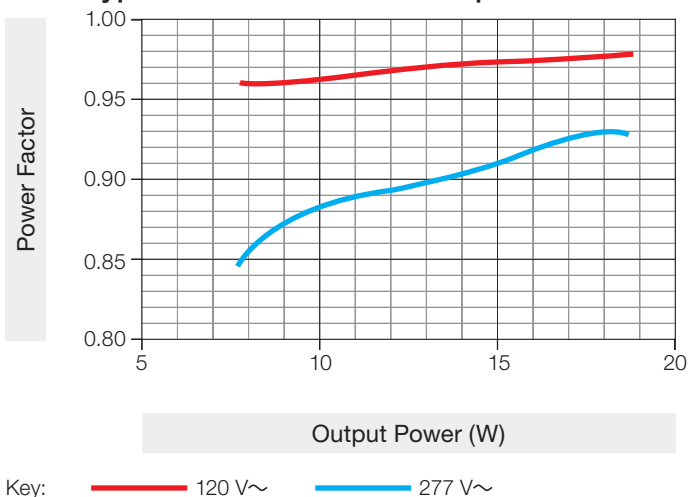

continued on next page...

Job Name:	Model Numbers:
Job Number:	

K-Case Models: "H" Output Range (continued)

Output Current and Compatible Load Voltage

Model Number* LDE14U1UKS/N	Rated Output Current (A)	Compatible Load Voltage (V)		Typical Performance at Minimum Compatible Load Voltage			Typical Performance at Maximum Compatible Load Voltage		
		Minimum	Maximum	Power Factor @ 120 V/277 V	THD @ 120 V/277 V	Efficiency @ 120 V/277 V	Power Factor @ 120 V/277 V	THD @ 120 V/277 V	Efficiency @ 120 V/277 V
-HA063	0.63	12.7	21.0	0.96/0.85	25%/21%	71%/72%	0.97/0.90	21%/19%	79%/80%
-HA064	0.64	12.5	21.0	0.96/0.85	25%/21%	71%/72%	0.97/0.90	21%/19%	79%/80%
-HA065	0.65	12.3	21.0	0.96/0.85	25%/21%	71%/72%	0.97/0.90	20%/19%	79%/80%
-HA066	0.66	12.1	21.0	0.96/0.85	25%/21%	71%/71%	0.97/0.90	20%/19%	79%/80%
-HA067	0.67	11.9	21.0	0.96/0.85	25%/21%	71%/71%	0.97/0.90	20%/19%	79%/81%
-HA068	0.68	11.8	21.0	0.96/0.85	25%/21%	70%/71%	0.97/0.90	20%/19%	79%/81%
-HA069	0.69	11.6	21.0	0.96/0.85	25%/21%	70%/71%	0.97/0.91	20%/19%	79%/81%
-HA070	0.70	11.4	21.0	0.96/0.85	25%/21%	70%/71%	0.97/0.91	20%/19%	80%/81%
-HA071	0.71	11.3	21.0	0.96/0.85	25%/21%	70%/71%	0.97/0.91	20%/19%	80%/81%
-HA072	0.72	11.1	21.0	0.96/0.85	25%/21%	70%/71%	0.97/0.91	20%/19%	80%/81%
-HA073	0.73	11.0	21.0	0.96/0.85	25%/21%	70%/70%	0.97/0.92	19%/19%	80%/81%
-HA074	0.74	10.8	21.0	0.96/0.86	25%/21%	70%/70%	0.97/0.92	19%/19%	80%/81%
-HA075	0.75	10.7	21.0	0.96/0.86	25%/21%	70%/70%	0.97/0.92	19%/19%	80%/81%
-HA076	0.76	10.5	21.0	0.96/0.86	25%/21%	70%/70%	0.97/0.92	19%/18%	80%/81%
-HA077	0.77	10.4	21.0	0.96/0.86	25%/21%	70%/70%	0.97/0.92	19%/18%	80%/81%
-HA078	0.78	10.3	21.0	0.96/0.86	25%/21%	69%/70%	0.97/0.92	19%/18%	80%/81%
-HA079	0.79	10.1	21.0	0.96/0.86	25%/21%	69%/70%	0.97/0.92	19%/18%	80%/81%
-HA080	0.80	10.0	21.0	0.96/0.86	25%/21%	69%/70%	0.98/0.92	19%/18%	80%/81%
-HA081	0.81	10.0	21.0	0.96/0.86	25%/21%	69%/70%	0.98/0.93	18%/18%	80%/81%
-HA082	0.82	10.0	21.0	0.96/0.86	25%/21%	69%/70%	0.98/0.93	18%/18%	80%/81%
-HA083	0.83	10.0	21.0	0.96/0.86	25%/21%	69%/70%	0.98/0.93	18%/18%	80%/81%
-HA084	0.84	10.0	21.0	0.96/0.86	25%/21%	69%/70%	0.98/0.93	18%/18%	80%/81%
-HA085	0.85	10.0	21.0	0.96/0.86	25%/21%	69%/70%	0.98/0.93	18%/18%	80%/81%
-HA086	0.86	10.0	20.9	0.96/0.87	24%/21%	69%/70%	0.98/0.93	18%/18%	80%/81%
-HA087	0.87	10.0	20.7	0.96/0.87	24%/20%	69%/70%	0.98/0.93	18%/18%	80%/81%
-HA088	0.88	10.0	20.5	0.96/0.87	24%/20%	69%/70%	0.98/0.93	18%/18%	80%/81%
-HA089	0.89	10.0	20.2	0.96/0.87	24%/20%	69%/70%	0.98/0.93	18%/18%	79%/81%
-HA090	0.90	10.0	20.0	0.96/0.87	24%/20%	69%/70%	0.98/0.93	18%/18%	79%/80%
-HA091	0.91	10.0	19.8	0.96/0.87	24%/20%	69%/70%	0.98/0.93	18%/18%	79%/80%
-HA092	0.92	10.0	19.6	0.96/0.87	24%/20%	69%/70%	0.98/0.93	18%/18%	79%/80%
-HA093	0.93	10.0	19.4	0.96/0.87	24%/20%	70%/70%	0.98/0.93	18%/18%	79%/80%
-HA094	0.94	10.0	19.1	0.96/0.88	24%/20%	70%/70%	0.98/0.93	18%/18%	79%/80%
-HA095	0.95	10.0	18.9	0.96/0.88	23%/20%	70%/70%	0.98/0.93	18%/18%	79%/80%
-HA096	0.96	10.0	18.8	0.96/0.88	23%/20%	70%/71%	0.98/0.93	18%/18%	79%/80%
-HA097	0.97	10.0	18.6	0.96/0.88	23%/20%	70%/71%	0.98/0.93	18%/18%	79%/80%
-HA098	0.98	10.0	18.4	0.96/0.88	23%/20%	70%/71%	0.98/0.93	18%/18%	79%/80%
-HA099	0.99	10.0	18.2	0.96/0.88	23%/20%	70%/71%	0.98/0.93	18%/18%	78%/80%
-HA100	1.00	10.0	18.0	0.96/0.88	23%/19%	70%/71%	0.98/0.93	18%/18%	78%/80%

* See How to Build a Model Number, K-Case Type page for a sample model number.

continued on next page...

 SPECIFICATION SUBMITTAL

Page

Job Name:	Model Numbers:
Job Number:	

K-Case Models: “H” Output Range (continued)**Output Current and Compatible Load Voltage** (continued)

Model Number* LDE14U1UKS/N	Rated Output Current (A)	Compatible Load Voltage (V)		Typical Performance at Minimum Compatible Load Voltage			Typical Performance at Maximum Compatible Load Voltage		
		Minimum	Maximum	Power Factor @ 120 V/277 V	THD @ 120 V/277 V	Efficiency @ 120 V/277 V	Power Factor @ 120 V/277 V	THD @ 120 V/277 V	Efficiency @ 120 V/277 V
-HA101	1.01	10.0	17.8	0.96/0.88	23%/19%	70%/71%	0.98/0.93	18%/18%	78%/79%
-HA102	1.02	10.0	17.6	0.96/0.88	23%/19%	70%/71%	0.98/0.93	18%/18%	78%/79%
-HA103	1.03	10.0	17.5	0.97/0.89	23%/19%	70%/71%	0.98/0.93	18%/18%	78%/79%
-HA104	1.04	10.0	17.3	0.97/0.89	23%/19%	70%/71%	0.98/0.93	18%/18%	78%/79%
-HA105	1.05	10.0	17.1	0.97/0.89	23%/19%	70%/71%	0.98/0.93	18%/18%	77%/79%

* See **How to Build a Model Number, K-Case Type** page for a sample model number.

Job Name:	Model Numbers:
Job Number:	

Dimensions

All measurements shown as: in (mm)

K Case

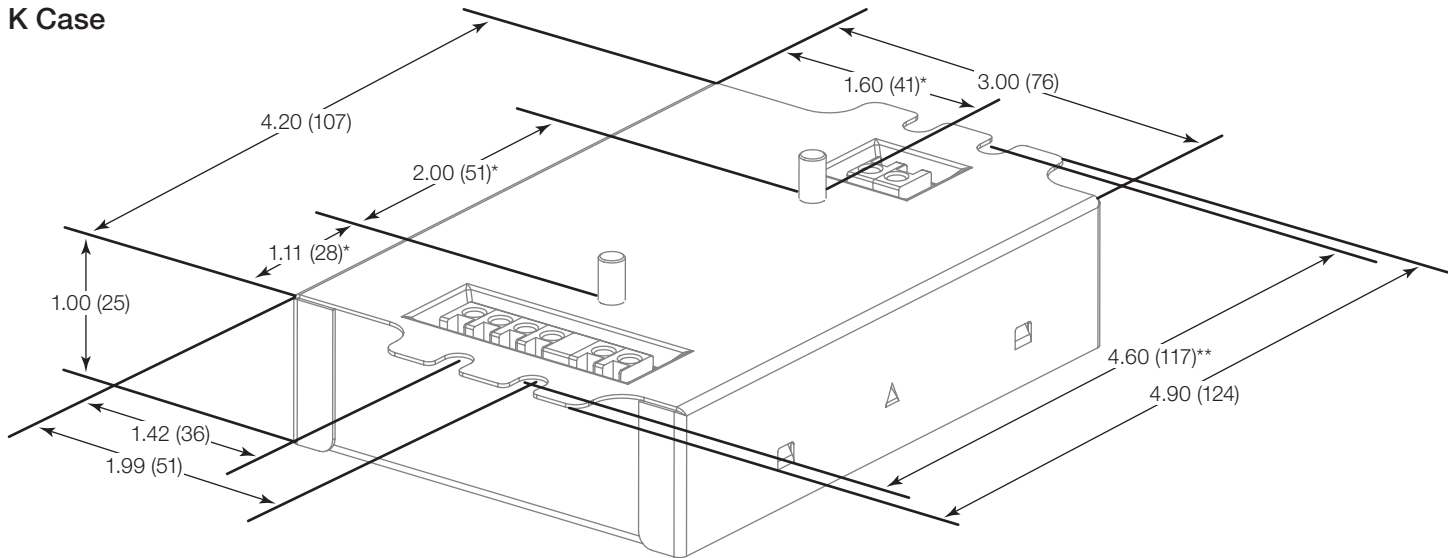

K Case Connector Locations

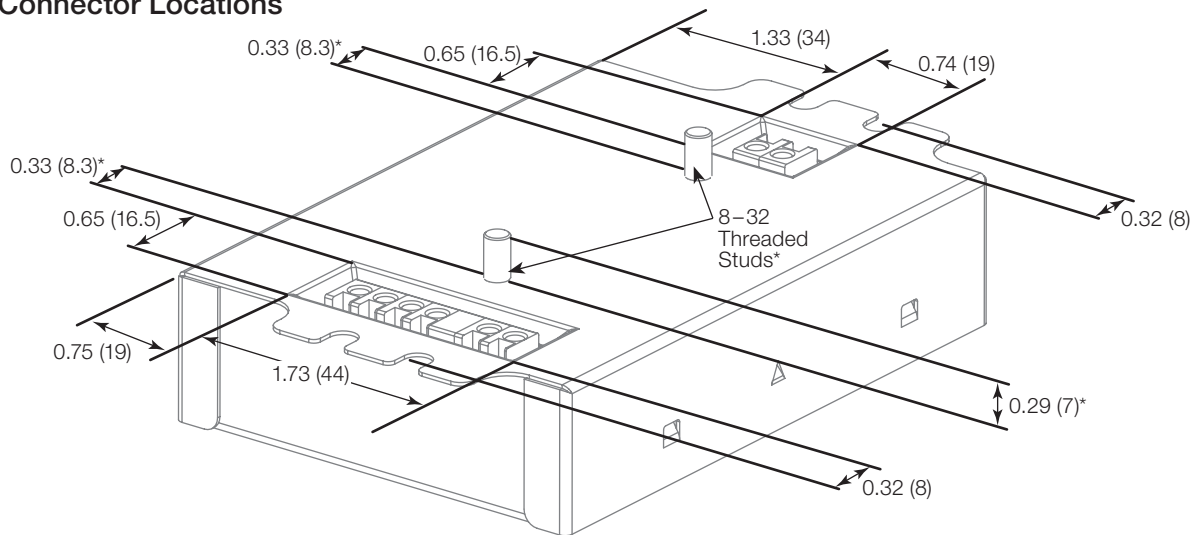

* Applies to studded K case only.

** Mounting center

continued on next page...

Job Name:	Model Numbers:
Job Number:	

Dimensions (continued)

All measurements shown as: in (mm)

K Case Side Entry Connector Locations*

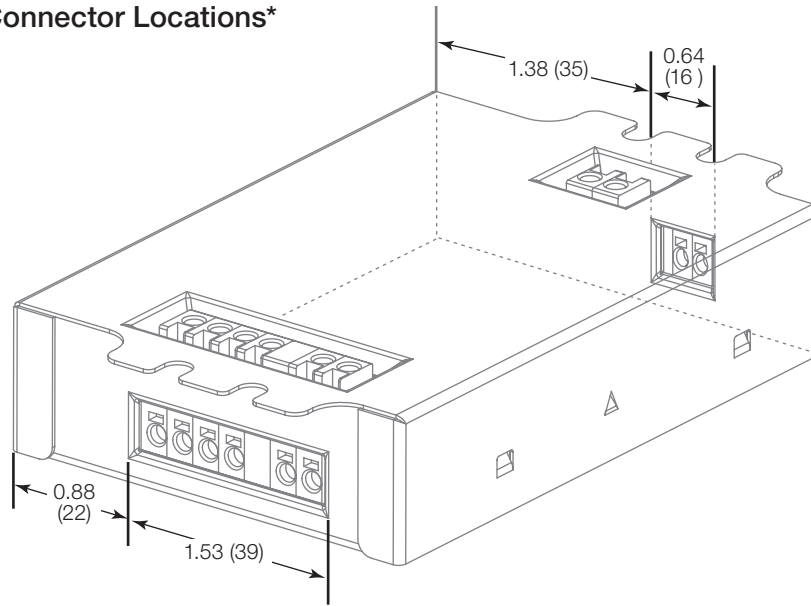

M Case

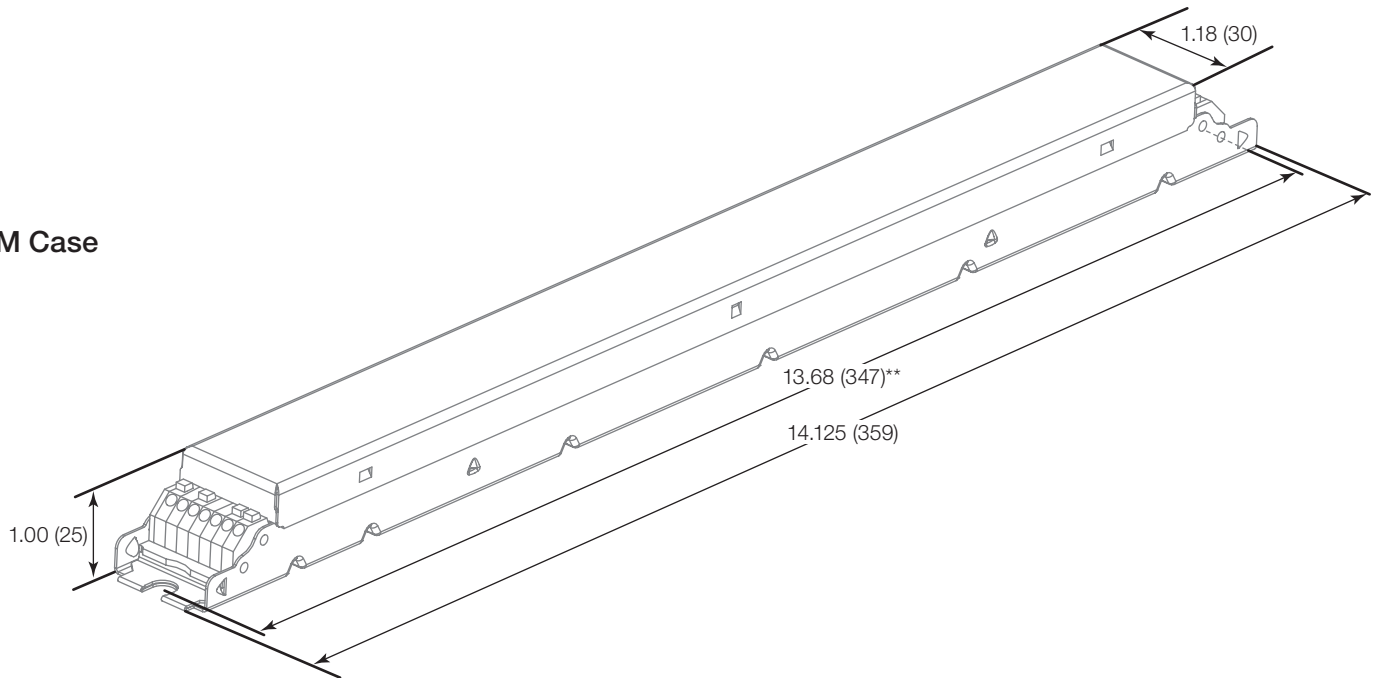

* Applies to non-studded K case only.

** Mounting center

Job Name:	Model Numbers:
Job Number:	

Terminal Wiring Gauges

Wire colors shown correspond to terminal blocks on driver.

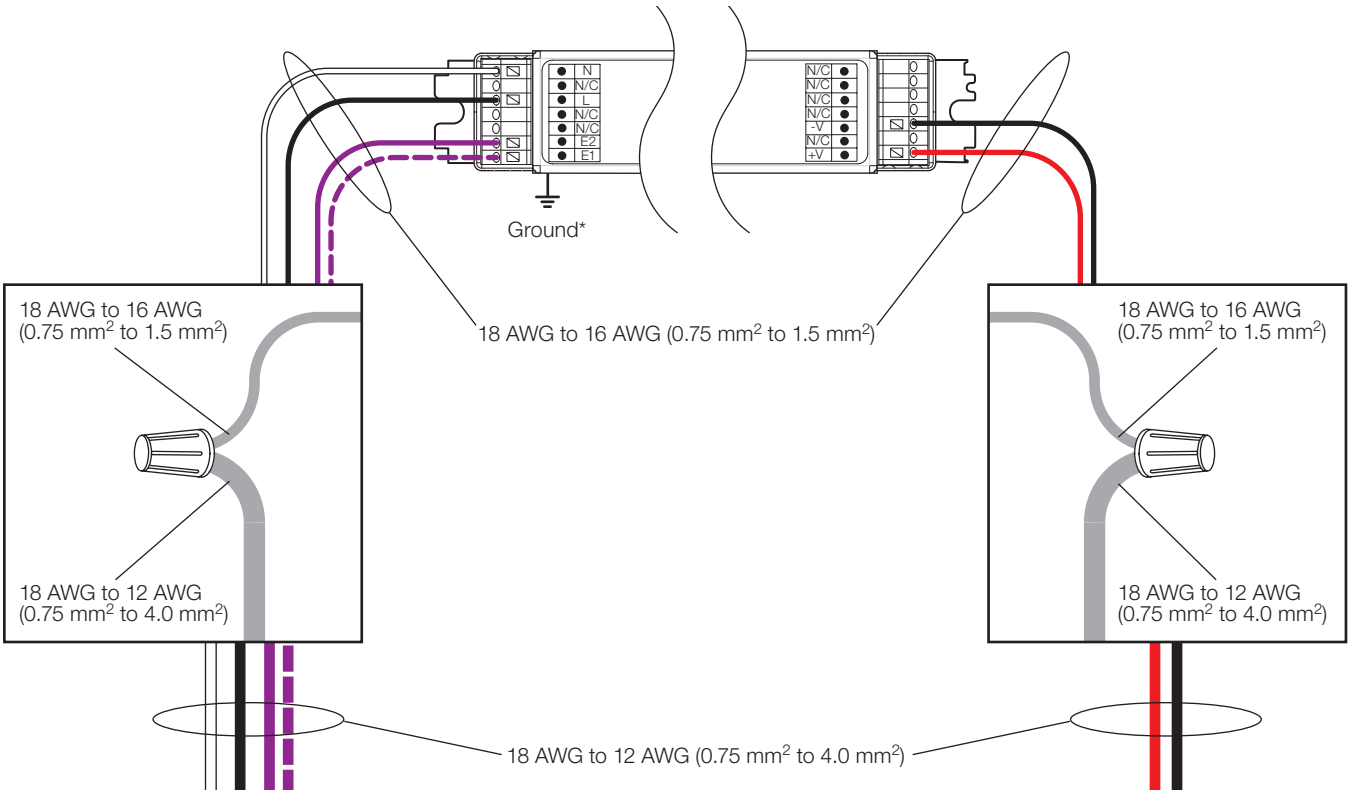

Wiring for EcoSystem Digital Control**

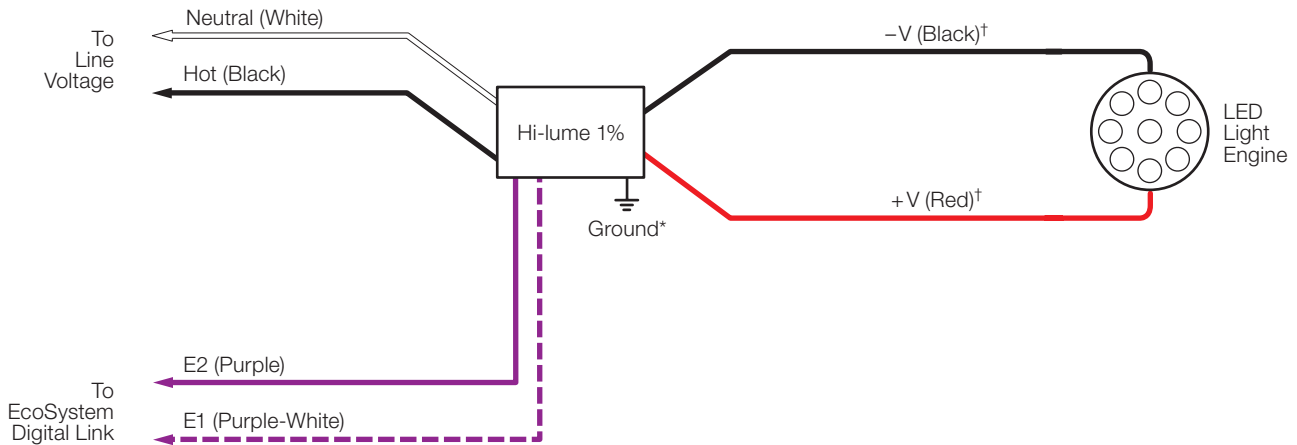

* Fixture and driver case must be grounded in accordance with local and national electrical codes. Ground connection to driver case can be accomplished through ground terminal, and/or grounding the case. Ground connection to M case driver (shown) requires connection to stud in fixture.

** Refer to Lutron Application note #142, "EcoSystem Bus Class 1 and Class 2 listing" for more information on wiring options.

† For maximum driver-to-LED light engine wire length, see charts in the **Driver Wiring and Mounting** section on page 2.

Job Name:	Model Numbers:
Job Number:	

Compatible Controls: Lutron EcoSystem Digital Controls

Guaranteed performance specifications with the controls listed in the chart below.

For assistance selecting controls, contact our LED Center of Excellence at **1.877.346.5338** or **LEDs@lutron.com**

Lutron EcoSystem Compatible Controls	Part Number		Drivers per Control			Measured Light Output Range
	120 V~	277 V~	EcoSystem Loops per Control	Drivers per EcoSystem Loop	Maximum Drivers per Control	
PowPak Dimming Modules	RMJ-ECO32-DV-B		1	32	32	100%-1%
	FCJ/FCJS-ECO ^{1,2}		1	3	3	100%-1%
Energi Savr Node	QSN-1ECO-S	N/A	1	64	64	100%-1%
	QSN-2ECO-S		2	64	128	
GRAFIK Eye QS / Homeworks QS control unit	QSGRJ-_E (wireless) QSGR-_E	N/A	1	64	64	100%-1%
Quantum Hub	QP2-__2C	N/A	2	64	128	100%-1%
	QP2-__4C		4	64	256	
	QP2-__6C		6	64	384	
	QP2-__8C		8	64	512	
Homeworks QS / myRoom Plus power module	LQSE-2ECO-D	N/A	2	64	128	100%-1%

¹ All devices connected to one FCJ/FCJS-ECO will be controlled together. Devices will dim to the same level as the result of a control command. For more detail on adjusting low-end light level refer to Application Note #556 at www.lutron.com.

² For the Line/Hot (L/H) terminal on the driver, it is preferred not to use the switched hot (red) wire from the control but rather the hot wire directly from the power source.

Job Name:	Model Numbers:
Job Number:	

EcoSystem Wiring

EcoSystem Digital Link Overview

- The EcoSystem Digital Link wiring (E1 and E2) connects the digital ballasts and drivers together to form a lighting control system.
- Sensors do not connect directly to Hi-lume 1% EcoSystem LED drivers. Sensors are integrated through the EcoSystem controllers.
- E1 and E2 (EcoSystem digital link wires) are polarity-insensitive and can be wired in any topology (e.g., T-tap and daisy-chain).
- Power is supplied to the EcoSystem Digital Link from the control system.

EcoSystem Digital Link Wiring

- EcoSystem Digital Link terminals accept only one 18 AWG to 16 AWG (0.75 mm² to 1.5 mm²) solid copper wire per terminal.
- Make sure that the supply breaker to the drivers and EcoSystem Digital Link Supply is OFF when wiring.
- Connect the two conductors to the two driver terminals E1 and E2 as shown.
- Using two different colors for E1 and E2 will reduce confusion when wiring several drivers together.
- The EcoSystem Digital Link may be wired Class 1 or Class 2. Consult applicable electrical codes for proper wiring practices.
- For emergency wiring, please refer to Lutron Application Note #106.

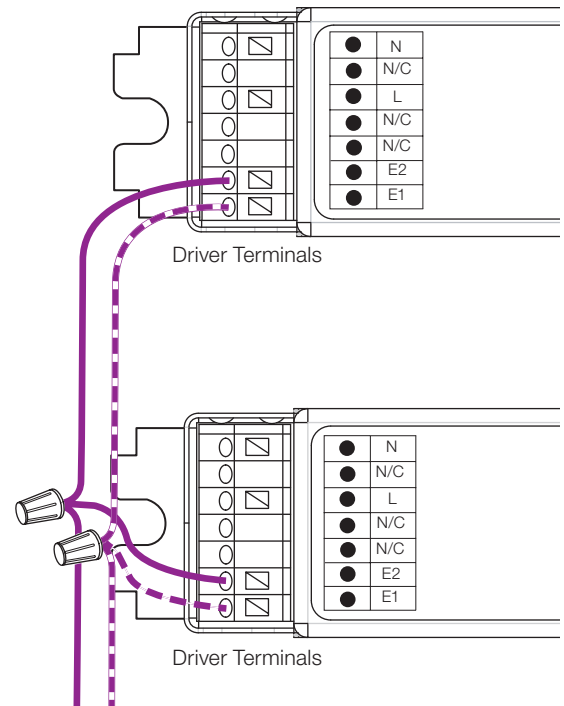

To the EcoSystem Digital Link Supply and additional drivers and/or ballasts

Notes

- The EcoSystem Digital Link Supply does not have to be located at the end of the Digital Link.
- EcoSystem Digital Link length is limited by the wire gauge used for E1 and E2 as follows:

Wire Gauge	Digital Link Length (max)
12 AWG*	2200 ft
14 AWG*	1400 ft
16 AWG	900 ft
18 AWG	550 ft

Wire Size	Digital Link Length (max)
4.0 mm ² *	828 m
2.5 mm ² *	517 m
1.5 mm ²	310 m
1.0 mm ²	207 m
0.75 mm ²	155 m

* Terminal blocks on the drivers accept only solid 18 to 16 AWG (0.75 mm² to 1.5 mm²) wire. To use wire gauges larger than the terminal blocks' rated gauge of 16 AWG (1.5 mm²) refer to the **Terminal Wiring Gauges** diagram. Connect up to 3 ft (1.0 m) of 18 to 16 AWG (0.75 mm² to 1.5 mm²) wire to the LED driver terminal blocks, then connect 12 or 14 AWG (4.0 mm² or 2.5 mm²) up to the length allowed in the above table.

Job Name:

Model Numbers:

Job Number:

Service

Warranty

For warranty information, please visit www.lutron.com/driverwarranty

Replacement Parts

When ordering Lutron replacement parts, please provide the full model number. Consult Lutron if you have any questions.

Further Information

For further information, please visit us at www.lutron.com/hilume1softbled or contact our LED Control Center of Excellence at 1.877.346.5338 or LEDs@lutron.com

 Lutron, Lutron, EcoSystem, Hi-lume, GRAFIK Eye, PowPak, Quantum, and HomeWorks are trademarks of Lutron Electronics Co., Inc. registered in the U.S. and other countries.

Soft-on, Fade-to-Black, Energi Savr Node, and QwikFig are trademarks of Lutron Electronics Co., Inc.

LUTRON SPECIFICATION SUBMITTAL

Page

Job Name:	Model Numbers:
Job Number:	