

| |
|-----------------|
| Project |
| Schedule / Date |
| Notes |
| Catalog Number |

Product Description

Our naturalLED® DLC Premium and Standard Flat Panels have an Integrated LED technology with a low profile design. The perfect solution for your interior lighting needs. Our lightweight LED flat panels provide a smooth and uniform light distribution from edge-to-edge for an even and consistent color design.

The LED Panel is designed for easy installation and maximum energy savings. The Flat Panel comes in standard configurations of 1x4, 2x2, and 2x4 for mounting in T-Bar/Grid ceilings. They can also be ordered with an optional surface mount/box kit.

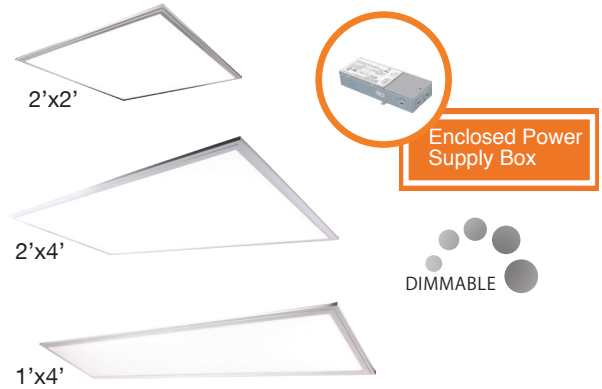

Features & Benefits

- ▶ DLC Premium/ Standard
- ▶ Lightweight for easy installation
- ▶ Uniform and excellent consistency
- ▶ Long Life LED Chip
- ▶ Excellent Thermal design

Specifications

- ▶ Input line voltage: 120-277
- ▶ Powerfactor >0.9
- ▶ Dimming 0-10V
- ▶ Operating temperature: -22°F ~ 122°F
- ▶ Available in 2'x2', 1'x4', 2'x4' configurations
- ▶ Beam Angle 120°
- ▶ Usage Temp: -4 - 113°F (-20 - 45°C)
- ▶ Storage Temp: -22 - 149°F (-30 - 65°C)

Applications

- ▶ Conferences/ Meeting Rooms
- ▶ Factories/ Offices
- ▶ Schools
- ▶ Hospitals
- ▶ Hospitalities
- ▶ Hotels



Optional Accessories

- ▶ Surface Mount Kit

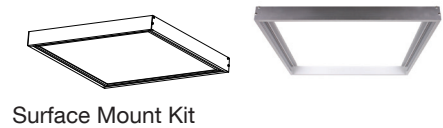

- ▶ Emergency LED Driver



Included with Fixture

- ▶ Earthquake Hook (Pre-installed)

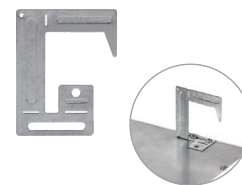

Earthquake Hook

Ordering Information

*P= Premium DLC / *S = Standard DLC

| Code | Description | CCT | Watt | Lumen | Equiv Wattage | Size | Beam Angle | Dim | Rated Hrs | DAMP LOCATION | DLC |
|------|---------------------|-------|------|-------|---------------|---------|------------|-------|-----------|---------------|-----|
| 7101 | LED-FXPNL32/1X4/840 | 4000K | 32 | 3,804 | 90-100W | 1' X 4' | 120° | 0-10V | 50,000 | • | P |
| 7100 | LED-FXPNL25/2X2/840 | 4000K | 25 | 3,040 | 60-70W | 2' X 2' | 120° | 0-10V | 50,000 | • | P |
| 7102 | LED-FXPNL40/2X4/840 | 4000K | 40 | 5,005 | 120-130W | 2' X 4' | 120° | 0-10V | 50,000 | • | P |
| 7721 | LED-FXPNL40/1X4/835 | 3500K | 40 | 4,149 | 90-100W | 1' X 4' | 120° | 0-10V | 50,000 | • | S |
| 7675 | LED-FXPNL40/1X4/840 | 4000K | 40 | 4,149 | 90-100W | 1' X 4' | 120° | 0-10V | 50,000 | • | S |
| 7686 | LED-FXPNL40/1X4/850 | 5000K | 40.8 | 4,600 | 90-100W | 1' X 4' | 120° | 0-10V | 50,000 | • | S |
| 7720 | LED-FXPNL40/2X2/835 | 3500K | 41 | 4,134 | 90-100W | 2' X 2' | 120° | 0-10V | 50,000 | • | S |
| 7674 | LED-FXPNL40/2X2/840 | 4000K | 41 | 4,134 | 90-100W | 2' X 2' | 120° | 0-10V | 50,000 | • | S |
| 7685 | LED-FXPNL40/2X2/850 | 5000K | 47 | 4,480 | 90-100W | 2' X 2' | 120° | 0-10V | 50,000 | • | S |
| 7722 | LED-FXPNL50/2X4/835 | 3500K | 47 | 4,652 | 120-130W | 2' X 4' | 120° | 0-10V | 50,000 | • | S |
| 7676 | LED-FXPNL50/2X4/840 | 4000K | 47 | 4,652 | 120-130W | 2' X 4' | 120° | 0-10V | 50,000 | • | S |
| 7687 | LED-FXPNL50/2X4/850 | 5000K | 48 | 5,062 | 120-130W | 2' X 4' | 120° | 0-10V | 50,000 | • | S |

Accessories (available for purchase)

Surface Mount Kit

P10096 MT-1x4BOX
(1 x 4 Surface Mount Kit)

P10097 MT-2x2BOX
(2 x 2 Surface Mount Kit)

P10098 MT-2x4BOX
(2 x 4 Surface Mount Kit)



Cable

P10147 MT-ACC-4FT
4-ft Earthquake Aircraft Cable

P10144 MT-ACC-10FT
10-ft Earthquake Aircraft Cable



Emergency Battery

7332 BAEM8.4-60/MV-B
(LED Emergency Backup Driver 120-277V)

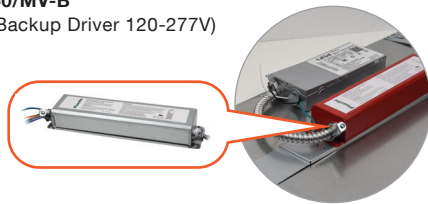

Accessory (Pre-installed)

Earthquake Hook

P10099 MT-PNL-HOOK-4PCS
(Earthquake hook for 2x2 and 1x4)

P10100 MT-PNL-HOOK-6PCS
(Earthquake hook for 2x4)

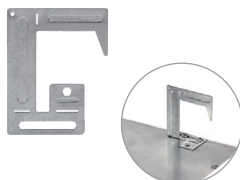

Photometric Data

1' x 4' (Premium DLC)

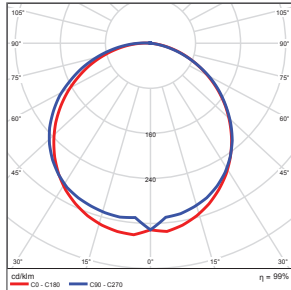

Zonal Lumen Summary

| Zone | Lumens | % Luminaire |
|--------|---------|-------------|
| 0-30 | 984.57 | 26.10 |
| 0-40 | 1623.74 | 43.10 |
| 0-60 | 2898.2 | 76.90 |
| 60-80 | 748.72 | 19.90 |
| 70-80 | 281.12 | 7.50 |
| 90-120 | 13.79 | 0.40 |
| 90-180 | 17.62 | 0.50 |
| 0-180 | 3768.87 | 100.00 |

Total Luminaire Efficiency = 100.00%

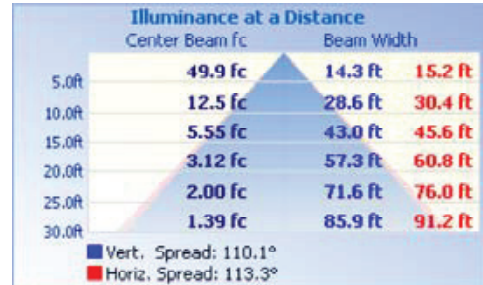

2' x 2' (Premium DLC)

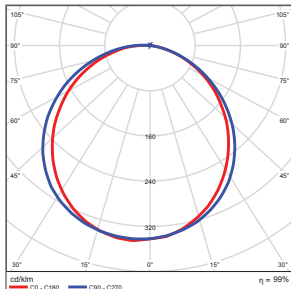

Zonal Lumen Summary

| Zone | Lumens | % Luminaire |
|--------|---------|-------------|
| 0-30 | 805.75 | 26.70 |
| 0-40 | 1320.55 | 43.70 |
| 0-60 | 2331.93 | 77.20 |
| 60-80 | 586.94 | 19.40 |
| 70-80 | 220.24 | 7.30 |
| 90-120 | 12.78 | 0.40 |
| 90-180 | 15.86 | 0.50 |
| 0-180 | 3020.81 | 100.00 |

Total Luminaire Efficiency = 100.00%

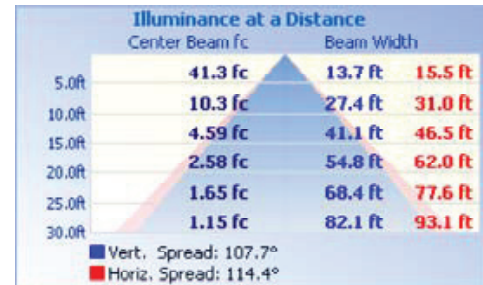

2' x 4' (Premium DLC)

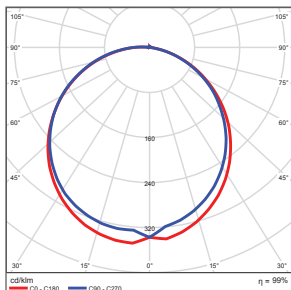

Zonal Lumen Summary

| Zone | Lumens | % Luminaire |
|--------|---------|-------------|
| 0-30 | 1321.26 | 26.20 |
| 0-40 | 2165.68 | 43.00 |
| 0-60 | 3843.01 | 76.30 |
| 60-80 | 1008.31 | 20.00 |
| 70-80 | 384.37 | 7.60 |
| 90-120 | 27.96 | 0.60 |
| 90-180 | 32.25 | 0.60 |
| 0-180 | 5039.69 | 100.00 |

Total Luminaire Efficiency = 100.00%

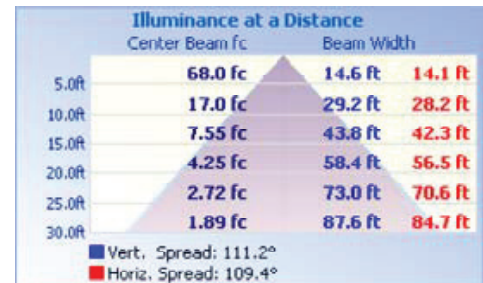

Photometric Data

1' x 4' (Standard DLC)

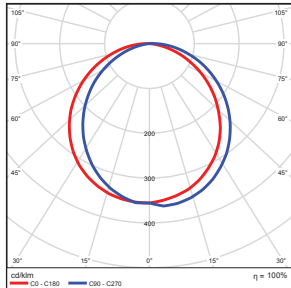

Zonal Lumen Summary

| Zone | Lumens | % Luminaire |
|--------|---------|-------------|
| 0-30 | 1122.04 | 27.50 |
| 0-40 | 1831.57 | 44.90 |
| 0-60 | 3208.57 | 78.70 |
| 60-80 | 774.61 | 19.00 |
| 70-80 | 284.61 | 7.00 |
| 90-120 | 5.74 | 0.10 |
| 90-180 | 5.74 | 0.10 |
| 0-180 | 4077.96 | 100.00 |

Total Luminaire Efficiency = 100.00%

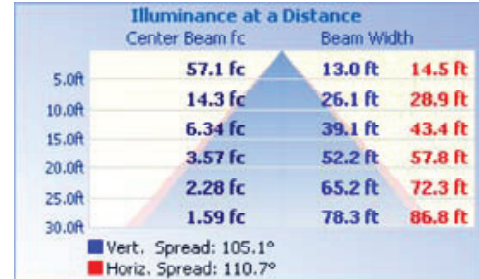

2' x 2' (Standard DLC)

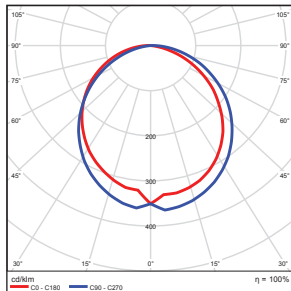

Zonal Lumen Summary

| Zone | Lumens | % Luminaire |
|--------|---------|-------------|
| 0-30 | 1112.95 | 27.30 |
| 0-40 | 1820.51 | 44.70 |
| 0-60 | 3205.25 | 78.70 |
| 60-80 | 775.97 | 19.10 |
| 70-80 | 281.88 | 6.90 |
| 90-120 | 5.62 | 0.10 |
| 90-180 | 5.62 | 0.10 |
| 0-180 | 4070.4 | 100.00 |

Total Luminaire Efficiency = 100.00%

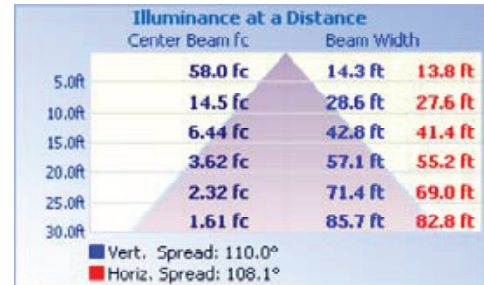

2' x 4' (Standard DLC)

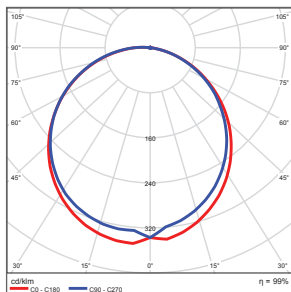

Zonal Lumen Summary

| Zone | Lumens | % Luminaire |
|--------|---------|-------------|
| 0-30 | 1263.09 | 27.30 |
| 0-40 | 2065.44 | 44.70 |
| 0-60 | 3636.83 | 78.70 |
| 60-80 | 882.33 | 19.10 |
| 70-80 | 320.64 | 6.90 |
| 90-120 | 6.47 | 0.10 |
| 90-180 | 6.47 | 0.10 |
| 0-180 | 4623.25 | 100.00 |

Total Luminaire Efficiency = 100.00%

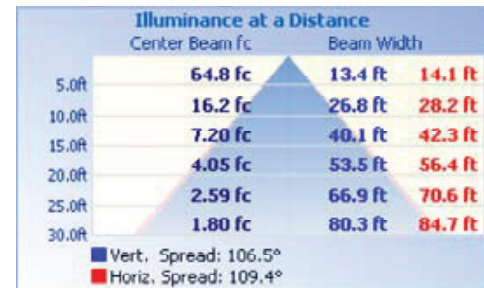

Surface Mount Kit

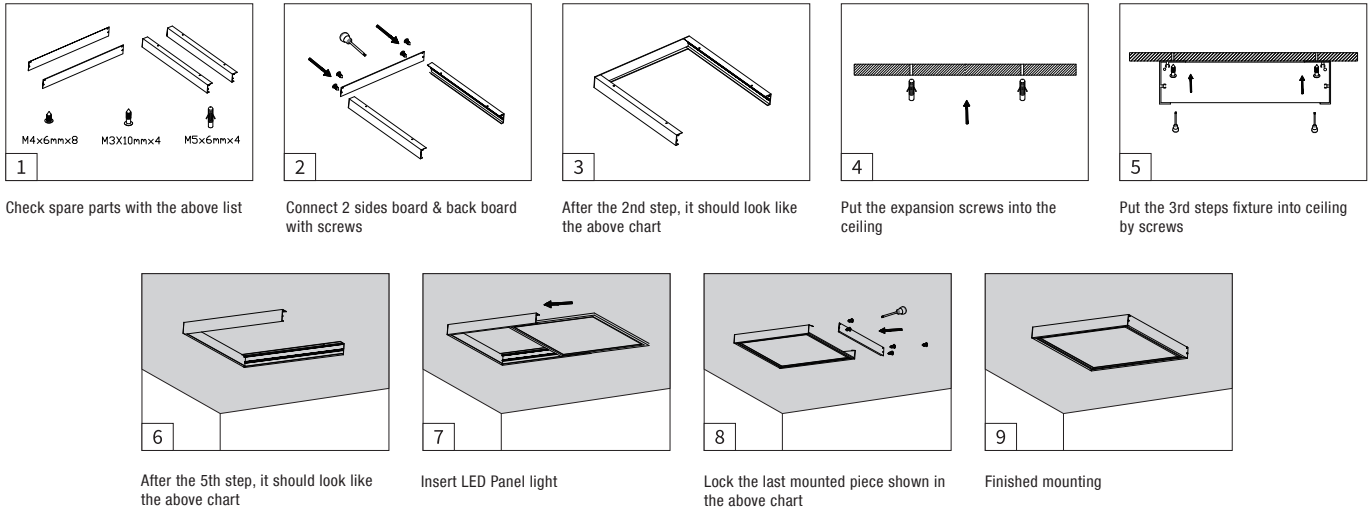

Earthquake Hook



1. Pull earthquake hook away from panel until facing perpendicular to the panel backing (Fig. 1).
2. Bend hook arm until facing perpendicular to the hook body (Fig. 2).
3. Hook panel light onto T-bars until panel is fully supported (Fig. 3).



Earthquake Hooks



Before Installation



After Installation

Product Dimension

2' x 2'

Weight: 7.15-lbs

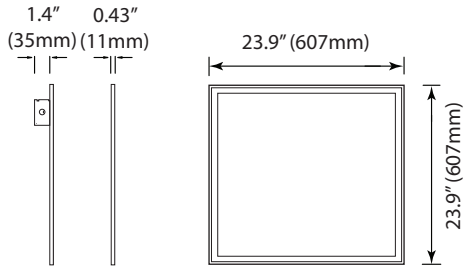

1' x 4'

Weight: 7.70-lbs

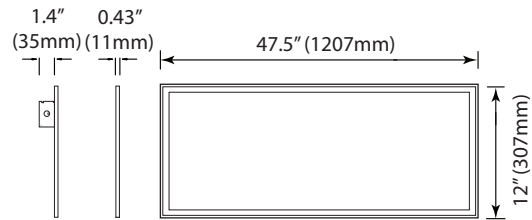

2' x 4'

Weight: 13.2-lbs

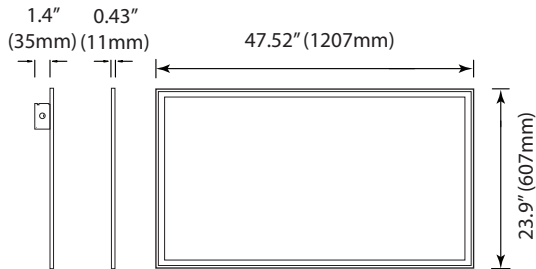

Package

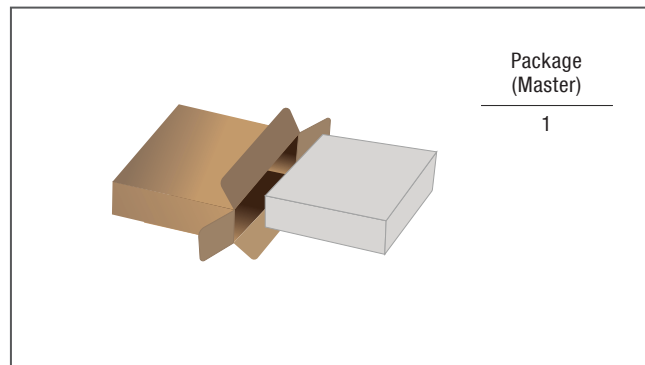

Surface Mount Kit Dimension

MT-2X2BOX

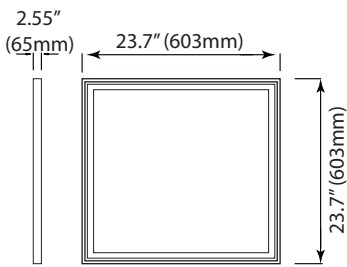

P10097 MT-2x2BOX
(2 x 2 Surface Mount Kit)

MT-2X4BOX

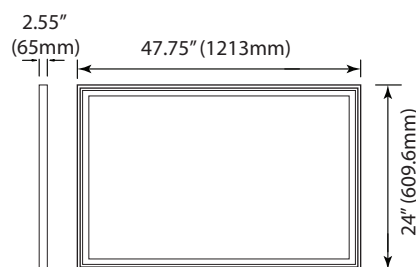

P10098 MT-2x4BOX
(2 x 4 Surface Mount Kit)

MT-1X4BOX

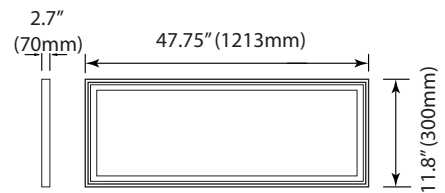

P10096 MT-1x4BOX
(1 x 4 Surface Mount Kit)