

Project _____
Schedule _____ Date _____
Notes _____

DESCRIPTION

naturalLED[®] features qualified DLC Back-Lit Flat Panels (PNL), an integrated LED technology with a low profile design and CCT selectable (3500K, 4000K, 5000K) and comes with additional 12V output for your control and accessories needs. This lightweight LED provides a smooth and uniform light distribution from edge-to-edge for an even and consistent color design. Perfect solution for your interior lighting needs for offices, schools, and meeting rooms. The Back-Lit Flat Panels are easily installed with maximum energy savings; comes in standard configurations of 1'x4', 2'x2', and 2'x4' for mounting in T-Bar/Grid ceilings or optional surface mount box kit.

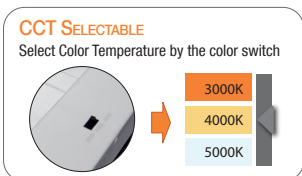
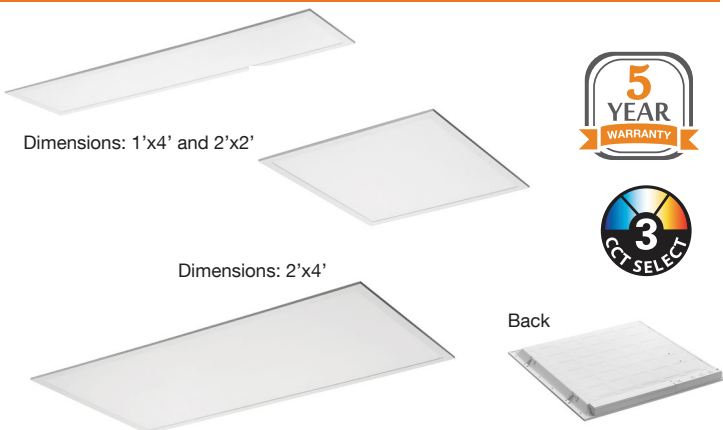

FEATURES

- DLC Standard
- For Damp Location
- ETL Listed
- Additional 12V output
- CCT3 Selectable (3500K, 4000K, 5000K)
- Lightweight and easy installation
- Uniform and consistent color from edge to edge
- LED emergency driver compatible
- Dimmable: 0-10V (Dim-to-Off)
- Input Voltage: 120-277V / 120-347V
- Power Factor: >0.9
- Surge Protection Level: 2.5KV
- Beam Angle: 115°
- Operating temperature: -4°F - 104°F

ACCESSORIES

- Ceiling Mount Box
- Flange Mounted Kit
- Emergency LED Driver + Bracket
- Earthquake Hook (Pre-installed)

APPLICATIONS

- Conference rooms
- Meeting rooms
- Offices
- Schools
- Hospitals

WARRANTY

- 5 Year Warranty

COLORS



Ordering Information		EXAMPLE: FXPNL40/2X2/8CCT3/347				
FX	PNL	40	2X2	8	CCT3	347
Category	Series	Wattage		Dimension	CRI	Color Temperature
FX Fixture	PNL Flat Panel	40	40W	2X2 2' x 2'	8 CRI 80	CCT3 Selectable
						Voltage
						Blank 120-277V 347 120-347V

ORDERING

*P= Premium DLC / *S = Standard DLC

	Watts (W)	Ordering Code	Description	Color Temp (K)	Lumens (lm)	Size	Equiv. Wattage (W)	Beam Angle	Voltage	DLC (S/P)
120-277V	40	9462	FXPNL40/1X4/8CCT3	3500K/4000K/5000K	4,400	1' X 4'	90-100W	115°	120-277V	S
	40	9460	FXPNL40/2X2/8CCT3	3500K/4000K/5000K	4,400	2' X 2'	90-100W	115°	120-277V	S
	50	9461	FXPNL50/2X4/8CCT3	3500K/4000K/5000K	5,500	2' X 4'	120-130W	115°	120-277V	S
120-347V	40	9465	FXPNL40/1X4/8CCT3/347	3500K/4000K/5000K	4,400	1' X 4'	90-100W	115°	120-347V	S
	40	9463	FXPNL40/2X2/8CCT3/347	3500K/4000K/5000K	4,400	2' X 2'	90-100W	115°	120-347V	S
	50	9464	FXPNL50/2X4/8CCT3/347	3500K/4000K/5000K	5,500	2' X 4'	120-130W	115°	120-347V	S

MOUNTING / ACCESSORIES

SOLD SEPARATELY

Ceiling Mount Kit

- P10334 MT-1X4BOX-4.5in



- P10335 MT-2X2BOX-4.5in



- P10336 MT-2X4BOX-4.5in



Flange Mounted Kit

- P10314 MT-1x4FMBOX (1'X4')
- P10228 MT-2x2FMBOX (2'X2')
- P10229 MT-2x4FMBOX (2'X4')

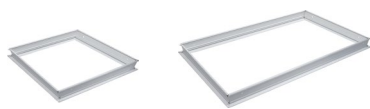

LED Panel Emergency Driver (Back-Lit) 120-277V

- K7335333 FXPNL-BAEM-MT1FT-BLP
(Emergency Backup Driver Mount Kit for 1'x4' Back-Lit)



- K7335332 FXPNL-BAEM-MT2FT-BLP
(Emergency Backup Driver Mount Kit for 2'x2' and 2'x4' Back-Lit)



Micro Inverter 120-347V

- 7337 BAEM25-170BC/347-C
25W Micro Inverter 120-347V with 12" Conduit (Field Installation)



SPECIFICATIONS

2'x 2'

Front

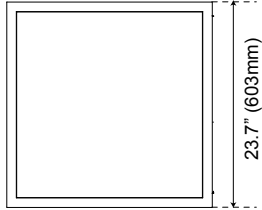

Back

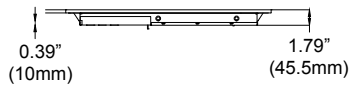
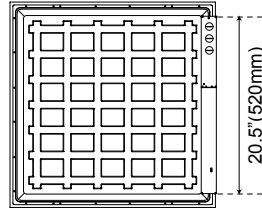

1'x 4'

Front

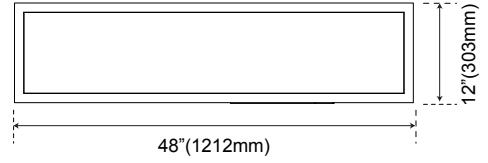

Back

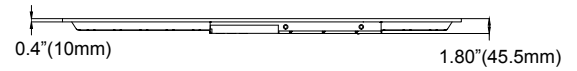
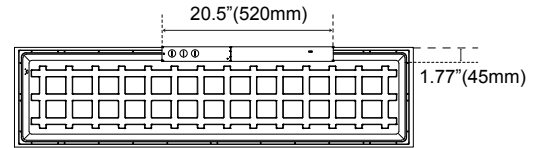

2'x 4'

Front

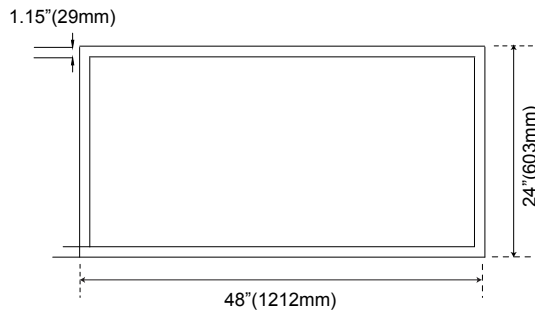

Back

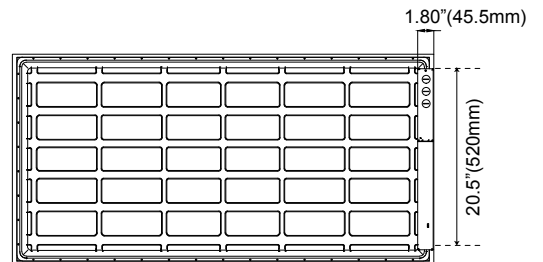

Side



PHOTOMETRICS CHART

FXPNL40 (2'x2')

DLC Standard

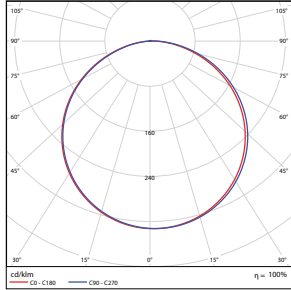

Illuminance at a Distance

Center Beam fc	Beam Width	
1.7ft	5.55 ft	5.5 ft
3.3ft	14.7 ft	10.7 ft
5.0ft	64.1 ft	16.3 ft
6.7ft	35.7 ft	21.8 ft
8.3ft	23.3 ft	27.0 ft
10.0ft	16.0 ft	32.5 ft

■ Vert. Spread: 116.0°
■ Horiz. Spread: 116.8°

FXPNL50 (2'x4')

DLC Standard

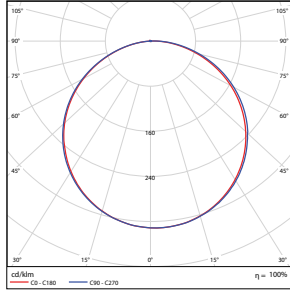

Illuminance at a Distance

Center Beam fc	Beam Width	
1.7ft	6.88 ft	5.6 ft
3.3ft	18.2 ft	10.9 ft
5.0ft	79.5 ft	16.4 ft
6.7ft	44.3 ft	22.0 ft
8.3ft	28.8 ft	27.3 ft
10.0ft	19.9 ft	32.9 ft

■ Vert. Spread: 115.6°
■ Horiz. Spread: 117.4°

FXPNL40 (1'x4')

DLC Standard

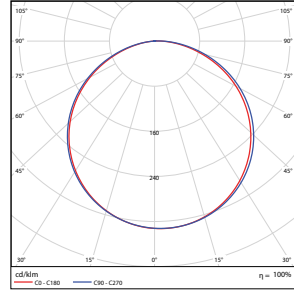

Illuminance at a Distance

Center Beam fc	Beam Width	
1.7ft	5.30 ft	5.6 ft
3.3ft	14.1 ft	10.9 ft
5.0ft	61.3 ft	16.5 ft
6.7ft	34.2 ft	22.1 ft
8.3ft	22.3 ft	27.4 ft
10.0ft	15.3 ft	33.0 ft

■ Vert. Spread: 115.0°
■ Horiz. Spread: 117.6°

PACKAGE

Master Pack: 2 pcs

