

natural^{led}

Turning Light into Savings ▶▶▶



VT Vapor Tight Linear

29W, 58W

Our linear vapor tight is housed in polycarbonate silicon perimeter gasket with brackets for mounting. Engineered for powerful lighting, the IP65-rated LED Vapor Tight Linear Fixtures are designed to replace fluorescent strip fixtures and can be used in parking garage, corporate campus, education facility, storage facility, car washes, tunnels and stairwell lighting.

Using up to 65% less energy and operating for up to 50,000 average life hours, our fixtures comes with a 5-foot extend cable for easy installation.

Key Features & Benefits

- ▶ Designed for maximum operation in commercial environments and can operate in wide range of temperatures (-22°F to 122°F)
- ▶ 4-ft in length
- ▶ Uniform and consistent color
- ▶ Lighter weight housing for easy installation
- ▶ Wide Beam Angle: 153°
- ▶ 5VA Flammability Rating
- ▶ Plastic latches standard
- ▶ 50,000 Hours rated average life
- ▶ Built-in Microwave Motion Sensor
- ▶ Comes with 5-foot power cord whip



Applications

- ▶ Corporate Campus Lighting
- ▶ Education Facilities Lighting
- ▶ Healthcare Facilities Lighting
- ▶ Parking Structure
- ▶ Tunnels
- ▶ Car Washes
- ▶ Stairwell Lighting

Qualifications



ORDERING INFORMATION

Item Code	Description	Color Temp	Wattage	Lumen Output	Equivalent Wattage	Beam Angle	Voltage	Dimmable	Sensor			
7448	LED-FXVTL29/40K	4000K	29	3,238	108	153°	120-277	0-10V		●	●	●
7449	LED-FXVTL29/50K	5000K	29	3,434	108	153°	120-277	0-10V		●	●	●
7450	LED-FXVTL58/40K	4000K	58	6,424	216	153°	120-277	0-10V		●	●	●
7451	LED-FXVTL58/50K	5000K	58	7,010	216	153°	120-277	0-10V		●	●	●

Microwave Motion Sensor Included

7582	LED-FXVTL29/40K-SEN	4000K	29	3,238	108	153°	120-277	0-10V	●	●	●	●
7583	LED-FXVTL29/50K-SEN	5000K	29	3,434	108	153°	120-277	0-10V	●	●	●	●
7584	LED-FXVTL58/40K-SEN	4000K	58	6,424	216	153°	120-277	0-10V	●	●	●	●
7585	LED-FXVTL58/50K-SEN	5000K	58	7,010	216	153°	120-277	0-10V	●	●	●	●

► Dimensions

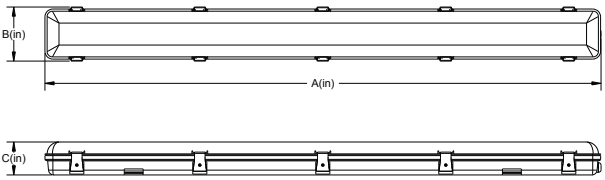
	Item	A	B	C	Weight (lbs)
	29W	49.84-in	4.84-in	2.95-in	4.75
	58W	49.84-in	4.84-in	2.95-in	5.42

► Illuminance Distribution

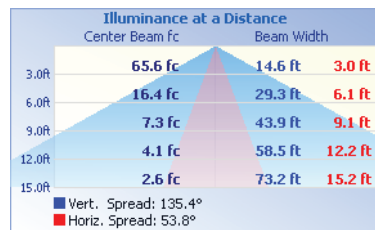
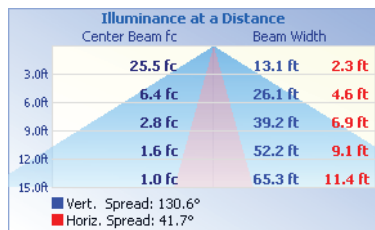
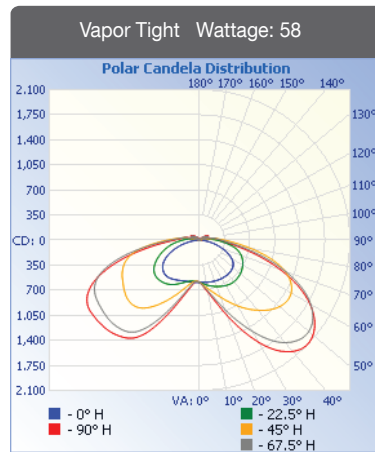
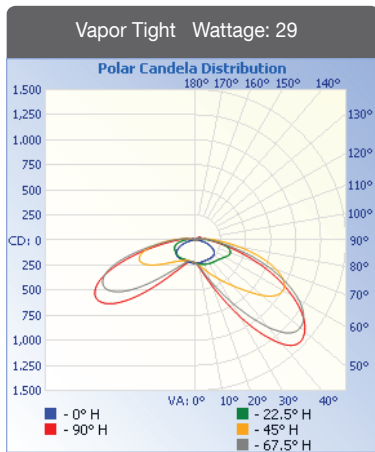

▶ Master Carton Package

