

LEDVANCE Lamps

SubstiKIT™ LED T5 & T8 Type C System

Application

SubstiKIT LED T5 & T8 Type C System pairs a dimmable direct current external driver with LED lamps. In applications utilizing multiple lamps, the external driver automatically adjusts the output current to avoid over driving remaining lamps and thus ensuring reliable system performance. It also provides 12Vdc auxiliary output that enables easy addition of wired/wireless controls and sensors to a project. That will not only maximize energy savings, but will provide high quality light for office, education, and retail applications.

Benefits and Features

- Select external drivers work with LEDVANCE LINK™ controls and sensors or other equivalent controls
- Available in 2ft, 3ft, 4ft linear and U-Bend options
- Includes RJ11 connector with lead wires for easy and quick installation for 0-10V dimming controls
- Dimmable down to 10% with dedicated Type C 0-10V driver to maximize energy savings and optimize light levels
- See System Data section below for DLC approved systems
- No warm-up time, instant-on with full light output and stable lamp-to-lamp color
- No UV emission
- System Efficacy up to 160 LPW
- 3000K, 3500K, 4100K, 5000K color temperatures
- CRI >80
- Beam angle: 200° with frosted glass optics
- Light Emitting Angle: 340°
- Can be used in enclosed (lens or diffuser) luminaire. Not approved for use in vapor tight or sealed luminaire.

Electrical

- Compatible with direct current dimmable SubstiKIT LED driver with input voltage of 120-277V (T5 & T8) or 347V (T8) per system table
- Power Factor >0.9
- THD <20%
- Dimmable (0-10V)
- Compatible with LEDVANCE EMBB (75740) except for T5HO lamp

Rated Life

- 70,000 hours (L₇₀)

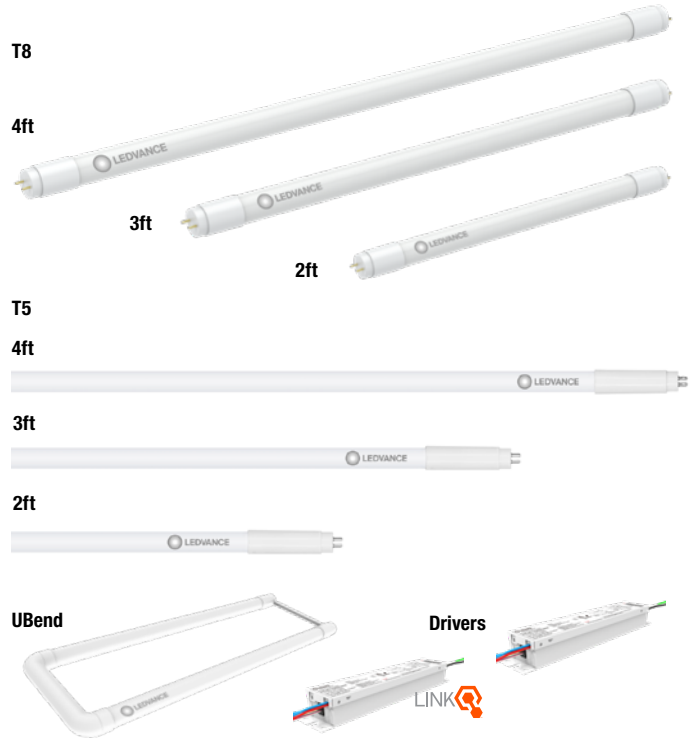

Warranty

- System (external direct-current driver & lamps) is covered by a 5-year limited warranty. For additional details, please visit www.ledvanceUS.com/warranty
- NLB Trusted Warranty Program

Operating Temperature

- -4°F to +113°F (-20°C to +45°C)

Max Case Temperature

- 167°F (75°C)

Certifications and Listings

- cETLus (UL1993, UL598c) - NSF (ANSI 2 – Food and CSA22.2) Equipment)
- RoHS - DLC 5.1*
- FCC & ICES (Part 15 Subpart B)

*See the System Data table for DLC listed products.

Installation

- Please refer to the Installation manual included inside the packaging and the applications information listed below for more information.

Catalog #	Type
Project	
Comments	
Prepared by	

Wattage Comparison

Traditional Source	Traditional System Wattage	LED System	Number of Lamps	LED System Wattage (Type B)	Energy Savings
2ft 17W T8 w/QHE 2X32T8/UNV ISN-SC	29	LED8T8L24FGDIM8XXDC170	2	18	38%
3ft 25W T8 w/ QHE 2X32T8/UNV ISN-IC	43	LED10T8L36FGDIM8XXDC220	2	23	47%
4ft 32W T8 w/QHE 2X32T8/UNV ISN-SC	55	LED10T8L48FGDIM8XXDC220	2	23	58%
4ft 32W T8 w/QHE 2X32T8/UNV ISN-SC	55	LED12T8L48FGDIM8XXDC255	2	27	51%
U-bend T8 w/ QHE 2X32T8/UNV ISN-IC	55	LED13T8UFGDIM830DC280	2	30	45%
2ft 14W T5 w/ QTP 2X28T5/UNV PSN	32	LED8T5L24FGDIM8XXDC165	2	17	46%
3ft 21W T5 w/QTP 2X28T5/UNV PSN	47	LED10T5L36FGDIM8XXDC210	2	23	51%
4ft 28W T8 w/QTP 2X28T5/UNV PSN	63	LED13T5L48FGDIM8XXDC275	2	30	52%
4ft 54W T5 w/QHE 2X54T5H0/UNV PSN	120	LED21T5H0L48FGDIM8XXDC450	2	45	63%

Ordering Guide (T8 Lamps)

LED	XX	T8	LXX	FG	DIM	8	XX	DC	XXX
Product Name	Wattage	Lamp Type	Length	FG = Frosted Glass	DIM = Dimmable	CRI = 8 = 82	Color Temperature	DC = DC Driver External Type C	Driver Output Current/Channel
LED	8 = 8 Watts 10 = 10.5 Watts 12 = 12 Watts 13 = 13.5 Watts	T8	L24 = 24 Inch L36 = 36 Inch L48 = 48 Inch U = U Bend				30 = 3000K 35 = 3500K 41 = 4100K 50 = 5000K		170 = 170 mA (8W/2ft) 220 = 220 mA (10.5W/3ft, 4ft) 255 = 255 mA (12W/4ft) 280 = 280 mA (13.5W/U-Bend)

Ordering Information (T8 Lamps)

Item Number	Ordering Abbreviation	Lamp Length	Lamp Power (W)	Initial Lumens (lm)	Bare Lamp Efficacy (LPW)	CCT	CRI	Lens	Life (L70) Hours	Beam Angle (°)	Package Qty
41934	LED8T8L24FGDIM830DC170	2ft	8	1100	138	3000	82	Frosted Glass	70,000	200	25
41935	LED8T8L24FGDIM835DC170	2ft	8	1100	138	3500	82	Frosted Glass	70,000	200	25
41936	LED8T8L24FGDIM841DC170	2ft	8	1100	138	4100	82	Frosted Glass	70,000	200	25
41937	LED8T8L24FGDIM850DC170	2ft	8	1100	138	5000	82	Frosted Glass	70,000	200	25
41938	LED10T8L36FGDIM830DC220	3ft	10.5	1380	131	3000	82	Frosted Glass	70,000	200	25
41939	LED10T8L36FGDIM835DC220	3ft	10.5	1380	131	3500	82	Frosted Glass	70,000	200	25
41940	LED10T8L36FGDIM841DC220	3ft	10.5	1450	138	4100	82	Frosted Glass	70,000	200	25
41941	LED10T8L36FGDIM850DC220	3ft	10.5	1450	138	5000	82	Frosted Glass	70,000	200	25
41942	LED10T8L48FGDIM830DC220	4ft	10.5	1725	164	3000	82	Frosted Glass	70,000	200	25
41943	LED10T8L48FGDIM835DC220	4ft	10.5	1850	176	3500	82	Frosted Glass	70,000	200	25
41944	LED10T8L48FGDIM841DC220	4ft	10.5	1850	176	4100	82	Frosted Glass	70,000	200	25
41945	LED10T8L48FGDIM850DC220	4ft	10.5	1850	176	5000	82	Frosted Glass	70,000	200	25
41946	LED12T8L48FGDIM830DC255	4ft	12	2050	171	3000	82	Frosted Glass	70,000	200	25
41947	LED12T8L48FGDIM835DC255	4ft	12	2200	183	3500	82	Frosted Glass	70,000	200	25
41948	LED12T8L48FGDIM841DC255	4ft	12	2200	183	4100	82	Frosted Glass	70,000	200	25
41949	LED12T8L48FGDIM850DC255	4ft	12	2200	183	5000	82	Frosted Glass	70,000	200	25
41950	LED13T8UFGDIM830DC280	U-Bend	13.5	2050	152	3000	82	Frosted Glass	70,000	200	10
41951	LED13T8UFGDIM835DC280	U-Bend	13.5	2200	163	3500	82	Frosted Glass	70,000	200	10
41952	LED13T8UFGDIM841DC280	U-Bend	13.5	2200	163	4100	82	Frosted Glass	70,000	200	10
41953	LED13T8UFGDIM850DC280	U-Bend	13.5	2200	163	5000	82	Frosted Glass	70,000	200	10

Ordering Guide (T5 Lamps)

LED	XX	T5	LXX	FG	DIM	8	XX	DC	XXX
Product Name	Wattage	Lamp Type	Length	FG = Frosted Glass	DIM = Dimmable	CRI 8 = 82	Color Temperature	DC = DC Driver External Type C	Driver Output Current/Channel
LED	8 = 8 Watts 10 = 10.5 Watts 13 = 13 Watts 21 = 21 Watts	T5	L24 = 24 Inch L36 = 36 Inch L48 = 48 Inch				30 = 3000K 35 = 3500K 41 = 4100K 50 = 5000K		165 = 165 mA (8W/2ft) 210 = 220 mA (10W/3ft) 275 = 275 mA (13W/4ft) 450 = 450 mA (21W/4ft)

Ordering Information (T5 Lamps)

Item Number	Ordering Abbreviation	Lamp Length	Lamp Power (W)	Initial Lumens (lm)	Bare Lamp Efficacy (LPW)	CCT	CRI	Lens	Life (L70) Hours	Beam Angle (°)	Package Qty
42485	LED8T5L24FGDIM830DC165	2ft	8	1100	138	3000	82	Frosted Glass	70,000	220	25
42486	LED8T5L24FGDIM835DC165	2ft	8	1100	138	3500	82	Frosted Glass	70,000	220	25
42487	LED8T5L24FGDIM841DC165	2ft	8	1100	138	4100	82	Frosted Glass	70,000	220	25
42488	LED8T5L24FGDIM850DC165	2ft	8	1100	138	5000	82	Frosted Glass	70,000	220	25
42489	LED10T5L36FGDIM830DC210	3ft	10	1380	138	3000	82	Frosted Glass	70,000	220	25
42490	LED10T5L36FGDIM835DC210	3ft	10	1380	138	3500	82	Frosted Glass	70,000	220	25
42491	LED10T5L36FGDIM841DC210	3ft	10	1450	145	4100	82	Frosted Glass	70,000	220	25
42492	LED10T5L36FGDIM850DC210	3ft	10	1450	145	5000	82	Frosted Glass	70,000	220	25
42493	LED13T5L48FGDIM830DC275	4ft	13	1800	138	3000	82	Frosted Glass	70,000	220	25
42494	LED13T5L48FGDIM835DC275	4ft	13	1800	138	3500	82	Frosted Glass	70,000	220	25
42495	LED13T5L48FGDIM841DC275	4ft	13	1890	145	4100	82	Frosted Glass	70,000	220	25
42496	LED13T5L48FGDIM850DC275	4ft	13	1890	145	5000	82	Frosted Glass	70,000	220	25
42497	LED21T5HOL48FGDIM830DC450	4ft	21	2880	137	3000	82	Frosted Glass	70,000	220	25
42498	LED21T5HOL48FGDIM835DC450	4ft	21	2880	137	3500	82	Frosted Glass	70,000	220	25
42499	LED21T5HOL48FGDIM841DC450	4ft	21	3024	144	4100	82	Frosted Glass	70,000	220	25
42500	LED21T5HOL48FGDIM850DC450	4ft	21	3024	144	5000	82	Frosted Glass	70,000	220	25

Ordering Guide (Drivers)

LEDvr	X-XL	TLED	XXX	XX-XXW	DIM	LINK
Product Name	Number of Lamps	Lamp Type	Input Voltage	Wattage Range on DIP Switch	DIM = Dimmable	LINK = Wireless Control
LEDVANCE Driver	1-2L = 1 or 2 Lamps* 1-3L = 1 or 3 Lamps 3-4L = 3 or 4 Lamps**	LED Tubes (Type C)	UNV = 120-277V 347V = 347V	9-30W = 9W min to 30W max 9-40W = 9W min to 40W max 27-54W = 27W min to 54W max 27-60W = 27W min to 60W max		

*Only powers one 21W T5HO lamp

**Only powers two 21W T5HO lamps

Ordering Information (Drivers)

Item Number	Ordering Abbreviation	Driver Input				Driver Output					
		Input Voltage (VAC)	Power Factor @ Full Load	THD @ Full Load	System Input Power (W)	Frequency (Hz)	Inrush Current Peak (A) @277V	Output Voltage (Vdc)	0-10V Dimming	Wireless Control	Package Qty
75846*	LEDvr1-2LTLEDUNV9-30WDIM	120-277	0.9	20%	9-30W	50/60	5	48	10%-100%	No	25
75847*	LEDvr3-4LTLEDUNV27-60WDIM	120-277	0.9	20%	27-60W	50/60	32	48	10%-100%	No	25
75881	LEDvr1-2LTLEDUNV9-30WDIM-LINK	120-277	0.9	20%	9-30W	50/60	5	48	10%-100%	LINK	25
75882	LEDvr3-4LTLEDUNV27-60WDIM-LINK	120-277	0.9	20%	27-60W	50/60	32	48	10%-100%	LINK	25
75848	LEDvr1-3LTLED347V9-40WDIM-LINK	347	0.9	20%	9-40W	50/60	5	48	10%-100%	LINK	25
75849	LEDvr3-4LTLED347V27-54WDIM-LINK	347	0.9	20%	27-54W	50/60	32	48	10%-100%	LINK	25

*Will be discontinued once the inventory is depleted.

Physical Information (Lamps)

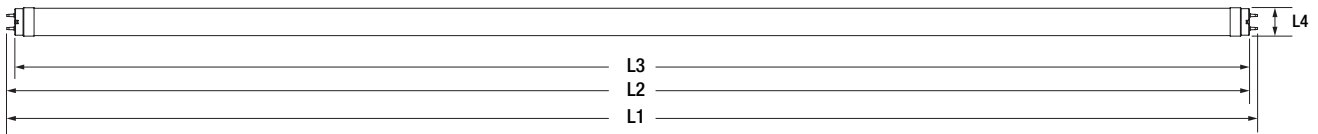

Lamp Description	L1 End of Base Pin to End of Opposite Pin End	L2 Base Face to Opposite Base Pin	L3 Base Face to Base Face	L4 Bulb Outside Diameter	Weight (lb/g)
LED8T8L24FGDIM8XXDC170	23.72" ±0.055" (602.6mm ±1.4mm)	23.45" ±0.05" (595.65mm ±1.25mm)	Max 23.22" (589.8mm)	1.02" ±0.08" (25.9mm ±2.0mm)	0.20/90
LED10T8L36FGDIM8XXDC220	35.72" ±0.055" (907.4mm ±1.4mm)	35.45" ±0.05" (900.45mm ±1.25mm)	Max 35.22" (894.6mm)	1.02" ±0.08" (25.9mm ±2.0mm)	0.29/130
LED10T8L48FGDIM8XXDC220	47.725" ±0.055" (1212.2mm ±1.4mm)	47.45" ±0.05" (1205.25mm ±1.25mm)	Max 47.22" (1199.4mm)	1.02" ±0.08" (25.9mm ±2.0mm)	0.39/175
LED12T8L48FGDIM8XXDC255	47.725" ±0.055" (1212.2mm ±1.4mm)	47.45" ±0.05" (1205.25mm ±1.25mm)	Max 47.22" (1199.4mm)	1.02" ±0.08" (25.9mm ±2.0mm)	0.39/175
LED8T5L24FGDIM8XXDC165	22.09" ±0.055" (561±1.4mm)	21.81±0.055" (554±1.25mm)	Max 21.53±0.055" (547 mm)	0.70±0.08" (17.84±2.0mm)	0.12/55
LED10T5L36FGDIM8XXDC210	33.90±0.055" (861±1.4mm)	33.62±0.055" (854±1.25mm)	Max 33.35±0.055" (847 mm)	0.70±0.08" (17.84±2.0mm)	0.19/84
LED13T5L48FGDIM8XXDC275	45.71±0.055" (1161±1.4mm)	45.43±0.055" (1154±1.25mm)	Max 45.16±0.055" (1147 mm)	0.70±0.08" (17.84±2.0mm)	0.24/109
LED21T5HOL48FGDIM8XXDC450	45.71±0.055" (1161±1.4mm)	45.43±0.055" (1154±1.25mm)	Max 45.16±0.055" (1147 mm)	0.70±0.08" (17.84±2.0mm)	0.25/112

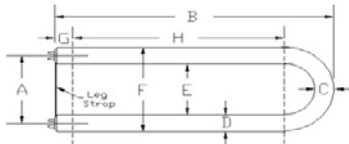

Lamp Description	A Lamp Legs, center to center End of Opposite Pin End	B Base Face to Lamp End	C Bulb Diameter in Bend	D Bulb Diameter in Legs	Weight (lb/g)
LED13T8UF8FGDIM8XXDC280	6" (152mm)	22.6" (574mm)	Max 1.15" (29.2mm)	1.10" (27.9mm)	0.44/200

Physical Information (Drivers)

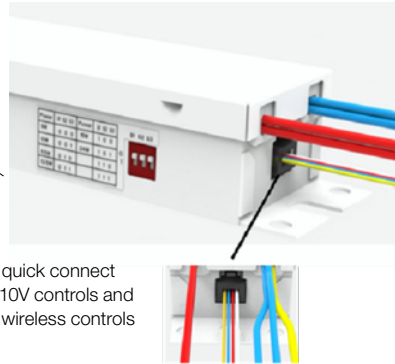
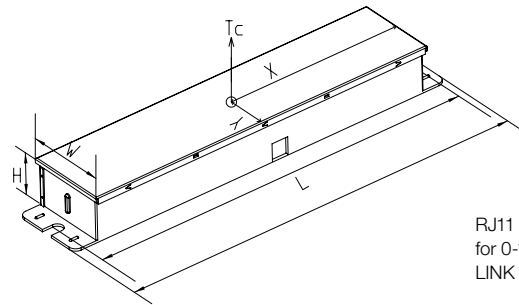

RJ11 quick connect
for 0-10V controls and
LINK wireless controls

P _{max} (W)	I _{max} (mA)	S1	S2	S3
9W*2	165mA*2	ON	ON	ON
10W*2	210mA*2	ON	—	ON
12W*2	253mA*2	—	—	ON
13W*2	281mA*2	ON	ON	—
21W*1	455mA*1	—	ON	—

Product Description	L x W x H Length x Width x Height	Mounting	Wiring Diagram
LEDvr1-2LTLEDUNV9-30WDIM	9.45" x 1.62" x 1.22" (240mm x 43mm x 31mm)	3.54" x 0.85" (90mm x 21.6mm)	A & C
LEDvr1-2LTLEDUNV9-30WDIM-LINK			*Only powers one 21W T5HO lamp – use diagram A
LEDvr3-4LTLEDUNV27-60WDIM	9.45" x 1.62" x 1.22" (240mm x 43mm x 31mm)	3.54" x 0.85" (90mm x 21.6mm)	B & D
LEDvr3-4LTLEDUNV27-60WDIM-LINK			*Only powers two 21W T5HO lamps – use diagram C
LEDvr1-3LTLED347V9-40WDIM-LINK	9.45" x 1.62" x 1.22" (240mm x 43mm x 31mm)	3.54" x 0.85" (90mm x 21.6mm)	A, B & C
LEDvr3-4LTLED347V27-54WDIM-LINK	9.45" x 1.62" x 1.22" (240mm x 43mm x 31mm)	3.54" x 0.85" (90mm x 21.6mm)	B & D

*T5HO only works with LINK drivers.

Wiring Diagram A

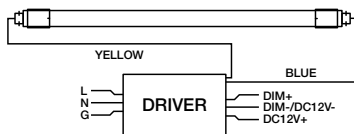

Wiring Diagram B

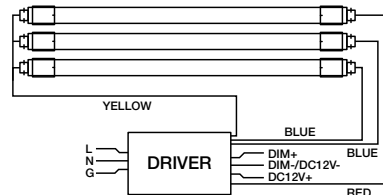

Wiring Diagram C

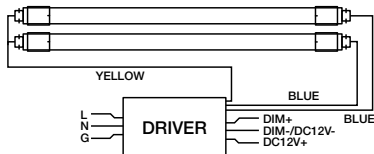

Wiring Diagram D

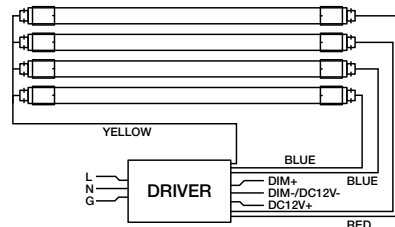

System Data (Drivers with T8 Lamps)

Driver Description	Lamp Description	Number of Lamps	System Wattage (W)	System Lumens (lm) @4100K	System Efficacy (LPW)	DLC
LEDvr1-2LTLEDUNV9-30WDIM	LED8T8L24FGDIM8XXDC170	1	9	1100	122	No
		2	18	2200	122	5.1
LEDvr1-2LTLEDUNV9-30WDIM-LINK						
LEDvr1-3LTLED347V9-40WDIM-LINK						
LEDvr3-4LTLEDUNV27-60WDIM	LED8T8L24FGDIM8XXDC170	3	27	3300	122	5.1
		4	36	4400	122	5.1
LEDvr3-4LTLEDUNV27-60WDIM-LINK						
LEDvr1-3LTLED347V9-40WDIM-LINK						
LEDvr3-4LTLED347V27-54WDIM-LINK						
LEDvr1-2LTLEDUNV9-30WDIM	LED8T8L24FGDIM8XXDC170	1	11.5	1450	126	No
		2	23	2900	126	5.1
LEDvr1-2LTLEDUNV9-30WDIM-LINK						
LEDvr1-3LTLED347V9-40WDIM-LINK						
LEDvr3-4LTLEDUNV27-60WDIM	LED10T8L36FGDIM8XXDC220	3	34.5	4350	126	N/A*
		4	46	5800	126	N/A*
LEDvr3-4LTLEDUNV27-60WDIM-LINK						
LEDvr1-3LTLED347V9-40WDIM-LINK						
LEDvr3-4LTLED347V27-54WDIM-LINK						
LEDvr1-2LTLEDUNV9-30WDIM	LED10T8L48FGDIM8XXDC220	1	11.5	1850	160	No
		2	23	3700	160	5.1
LEDvr1-2LTLEDUNV9-30WDIM-LINK						
LEDvr1-3LTLED347V9-40WDIM-LINK						
LEDvr3-4LTLEDUNV27-60WDIM	LED10T8L48FGDIM8XXDC220	3	34.5	5175	160	5.1
		4	46	7400	160	5.1
LEDvr3-4LTLEDUNV27-60WDIM-LINK						
LEDvr1-3LTLED347V9-40WDIM-LINK						
LEDvr3-4LTLED347V27-54WDIM-LINK						
LEDvr1-2LTLEDUNV9-30WDIM	LED12T8L48FGDIM8XXDC255	1	13.5	2200	160	No
		2	27	4400	160	5.1
LEDvr1-2LTLEDUNV9-30WDIM-LINK						
LEDvr1-3LTLED347V9-40WDIM-LINK						
LEDvr3-4LTLEDUNV27-60WDIM	LED12T8L48FGDIM8XXDC255	3	40.5	6600	160	5.1
		4	54	8800	160	5.1
LEDvr3-4LTLEDUNV27-60WDIM-LINK						
LEDvr1-3LTLED347V9-40WDIM-LINK						
LEDvr3-4LTLED347V27-54WDIM-LINK						
LEDvr1-2LTLEDUNV9-30WDIM	LED13T8UFGDIM8XXDC280†	1	15	2200	147	No
		2	30	4400	147	5.1
LEDvr1-2LTLEDUNV9-30WDIM-LINK						
LEDvr3-4LTLEDUNV27-60WDIM-LINK	LED13T8UFGDIM8XXDC280†	3	45	6600	147	No
		4	60	8800	147	No

*No DLC category for these lamp combinations.
†U-bend lamps are not compatible with 347V input drivers.

System Data (Drivers with T5 Lamps)

Driver Description	Lamp Description	Number of Lamps	System Wattage (W)	System Lumens (lm) @4100K	System Efficacy (LPW)	DLC
LEDvr1-2LTLEDUNV9-30WDIM-LINK	LED8T5L24FGDIM8XXDC165	1	8.85	1068	121	N/A*
		2	17.33	2158	125	N/A*
LEDvr3-4LTLEDUNV27-60WDIM-LINK	LED8T5L24FGDIM8XXDC165	3	26.09	3263	125	N/A*
		4	35.24	4445	126	N/A*
LEDvr1-2LTLEDUNV9-30WDIM-LINK	LED10T5L36FGDIM8XXDC210	1	11.51	1406	122	N/A*
		2	22.96	2858	124	N/A*
LEDvr3-4LTLEDUNV27-60WDIM-LINK	LED10T5L36FGDIM8XXDC210	3	32.25	4068	126	N/A*
		4	45.81	5819	127	N/A*
LEDvr1-2LTLEDUNV9-30WDIM-LINK	LED13T5L48FGDIM8XXDC275	1	14.44	2092	145	5.1
		2	29.98	4221	141	5.1
LEDvr3-4LTLEDUNV27-60WDIM-LINK	LED13T5L48FGDIM8XXDC275	3	44.11	6600	150	5.1
		4	59.49	8461	142	5.1
LEDvr1-2LTLEDUNV9-30WDIM-LINK	LED21T5HOL48FGDIM8XXDC450	1	22.95	3250	142	5.1
LEDvr3-4LTLEDUNV27-60WDIM-LINK	LED21T5HOL48FGDIM8XXDC450	2	44.96	6500	145	5.1

*No DLC category for these lamp combinations.

Compatible Dimmer List

Manufacturer	Model Number	Dimmer Type
Leviton	IP710	0-10V
Lutron	DS710	0-10V
Lutron	DVSTV	0-10V
Lutron	DVTV	0-10V
Lutron	NTSTV	0-10V

Accessories for LEDVANCE LINK™ Control System (Optional)

Item Number	Model Number	Description
62630	ADAPTERAUX12VBLE	Bluetooth® Controller
62633	SENSORCEILINGPIR12VBLE	Bluetooth® Daylight Harvesting and PIR Motion Sensor
62634	SENSORHBP1RAUX12VBLE	Bluetooth® Daylight Harvesting and PIR Motion Sensor
62636	WALLSWITCH5KEYBLE	Bluetooth® Mesh Low Voltage 5 Button Controller

Click here for additional information: <https://www.ledvanceus.com/products/controls/Field-installable-controls/Pages/control-components.aspx>



62630



62633



62634



62636

Application Information

1. These LED lamps require an external driver and are intended to be used with LEDVANCE branded direct-current drivers included in this specification as a UL Approved Type C System.
2. All installation, inspection, and maintenance of lighting fixtures should be done with the power to the fixture turned off. Lamps should be installed and operated in compliance with the National Electrical Code (NEC), Underwriters Laboratories Inc. (UL) requirements, and all applicable codes and regulations.
3. EM ballast that operates with fluorescent ballasts must be disconnected from the lamps.
4. Ensure lamp holders/sockets are in good operating condition before installation.
5. Please do not install LED lamps and fluorescent lamps in the same fixture.
6. Insert and align tubes properly in lamp holders. Partial insertion results in a poor or intermittent electrical contact that can result in short lamp life and arcing. Arcing at the lamp holder can result in localized overheating.
7. Approved for use with shunted or non-shunted lamp holders. For non-shunted lamp holders, please shunt them externally.
8. Best practice: cap off the remaining ballast wires should the ballast be left in the fixture after disconnecting.
9. To prevent wiring damage or abrasion, do not expose wiring to edges of sheet metal or other sharp objects. Do not make or alter any open holes in an enclosure of wiring or electrical components during kit installation.
10. Refer to the label on the driver for proper DIP switch arrangement for appropriate lamp power.
11. Do not use 3-4 lamp driver to operate less than 3 lamps for T8. Exception: This driver can only be used to power 2 T5HO lamps.
12. Do not use 1-2 lamp driver to operate more than one 1 T5HO lamp.
13. U-bend and T5 lamps are not compatible with 347V drivers.
14. Operating temperature range between -4°F and 113°F (-20°C and 45°C).
15. Storage temperature range between -4°F and 176°F (-20°C and 80°C).
16. Suitable for use in dry and damp environments. LINK components are not rated for outdoor applications.
17. Please read all installation instructions before attempting installation.
18. For detailed warranty information, please see www.ledvanceUS.com.

LEDVANCE LLC
 181 Ballardvale Street, Suite 203
 Wilmington, MA 01887 USA
 Phone: 1-800-LIGHTBULB (1-800-544-4828)
www.ledvanceUS.com

LEDVANCE is a registered trademark.
 The Bluetooth® word mark and logos are registered trademarks owned by the Bluetooth SIG, Inc. and any use of such marks by LEDVANCE LLC is under license.
 All other trademarks are those of their respective owners.
 Specifications subject to change without notice.



SCAN TO FOLLOW US
 ON SOCIAL MEDIA

