

SYLVANIA Lamps

DULUX® LED Pin Base Lamps

LED replacement for conventional Compact Fluorescent Lamps for use in ECG luminaires or directly on line voltage

Application

DULUX LED Pin Based lamps are an energy saving alternative, designed to replace traditional compact fluorescent lamps. These LED lamps contain no mercury, and provide instant light and a uniform light distribution. These lamps are offered in SubstiTUBE® (UL Type A/ballast compatible), LEDlescent™ (UL Type B/ballast-free), or DUALescent™ (UL Type A+B), depending on which family/wattage is chosen. These lamps also minimize labor and recycling costs.

Benefits and Features

- DLC listed lamps allow for rebates in areas where applicable, saving on overall project cost
- System LPW varies from 93 to 134
- CRI >80
- Offered in 3.5, 5.5, 6, 7, 8, 8.5, 9.5, 15 or 16 watts
- Available beam angle:
 - Omnidirectional lamps with 360° beam angle and light emitting angle of 360°
 - High output lamps with either 110° or 120° beam angle and light emitting angle of 260°
 - CCT Selectable lamps with either 110° or 120° beam angle and light emitting angle of 150° or 360°
 - Ultra thin beam angle 160°, and light emitting area 320°
- Energy savings up to 68%

Electrical

- SubstiTUBE lamps are compatible with electronic (4-pin) or magnetic (2-pin GX23) ballast; LEDlescent lamps are operated directly wired to line voltage; DUALescent can be operated either on magnetic ballasts or directly wired to line voltage, either 2-pin or 4-pin lamp holders
- Lamps with "DIM" in the description are 0-10V dimmable with select compatible 0-10V dimming ballasts
- Power Factor >0.9
- THD <20%

Certifications and Listings

- cULus 1993, cULus 1598c for Type B lamps
- DLC 5.1 for some lamps
- RoHS
- NSF Listed: NSF/ANSI Standard 2 – Food Equipment
- FCC Title 47 CFR, Part 15 Non-Consumer
- Mercury Free



Wattage Comparison

Traditional Source	Traditional System Wattage	LED System Wattage	Energy Savings
CF42DT/E w/QTP2X26/32/42CF/UNV DM	94	30	68%
CF32DT/E w/QTP2X26/32/42CF/UNV DM	69	30	57%
CF26DD/E w/QTP2X26/CF/UNV DM	54	19	65%
CF18DD/E w/QTP1/2X18CF/UNV DM	38	14	63%
CF26DD/E w/QTP2X26/CF/UNV DM	54	19	65%
CF42DT/E w/QTP2X26/32/42CF/UNV DM	94	31	67%
CF32DT/E w/QTP2X26/32/42CF/UNV DM	69	33	52%
CF26DD w/C2642UNVME	26	8.5	67%
CF18DD w/C218UNVME	18	7	61%
CF26DD w/C2642UNVME	26	9	65%
CF7DS/8XX or CF9DS/8XX	7	3.5	50%
CF13DS/8XX	13	5.5	58%
CF7DS/E/8XX or CF9DS/E/8XX	7	3.5	50%
CF13DS/E/8XX	13	5.5	58%

*Energy savings over life of lamp calculated at \$0.11/kWh

Rated Life

- 50,000 hours (L₇₀)

Warranty

- 5 year limited lamp warranty (24/7 operation)
- NLB Trusted Warranty Program

Ambient Operating Range

- -4°F to +104°F (-20°C to +40°C)



Catalog #	Type
Project	
Comments	
Prepared by	

Installation

Please refer to the installation manual included inside the packaging for more information.

Ordering Guide

LED	XX	PB	XXXX	X	DIM	8	XX	XXX
Product Name	Wattage	Pin Base	Base Type	Orientation	Dimmable	CRI	Color Temperature	UL Type
LED = LED Technology	3.5 = 3.5W 5.5 = 5.5W 6 = 6W 7 = 7W 8.5 = 8.5W 9 = 9W 9.5 = 9.5W 15 = 15W 16 = 16W		2G7 = 4-pin 2GX7 = 4-pin G23 = 2-pin GX23 = 2-pin G24D = 2-pin G24Q = 4-pin	V = Vertical H = Horizontal O = Omnidirectional		8 = 80+	27 = 2700K 30 = 3000K 35 = 3500K 41 = 4100K SC1 = CCT Selectable 3000K/3500K/4100K	BF = Type B SUB = Type A AB = Type AB

Ordering Information

Item Number	Ordering Abbreviation	Lamp Wattage (W)	Base Type	Replaces	Input Voltage (V)	Avg. Life (hrs)	CCT	Typical Lumens (lm)	CRI	Power Factor	Bulb Finish	Case Qty.	DLC Listed*
SubstiTUBE®													
40448	LED6PBGX23H827	6	GX23	CF13DS/ECO	Ballast dependent	50,000	2700K	625	80+	>0.9	Frosted Glass	24	N/A
40449	LED6PBGX23H835	6	GX23	CF13DS/ECO	Ballast dependent	50,000	3500K	625	80+	>0.9	Frosted Glass	24	N/A
40450	LED6PBGX23H841	6	GX23	CF13DS/ECO	Ballast dependent	50,000	4100K	625	80+	>0.9	Frosted Glass	24	N/A
SubstiTUBE High Output													
41705	LED15PBG24QHDIM830SUB	15	G24Q/GX24Q	CF42DT/E	Ballast dependent	50,000	3000K	1900	80+	>0.9	Plastic	24	5.1
41706	LED15PBG24QVDIM830SUB	15	G24Q/GX24Q	CF42DT/E	Ballast dependent	50,000	3000K	2000	80+	>0.9	Plastic	24	5.1
41707	LED15PBG24QHDIM835SUB	15	G24Q/GX24Q	CF42DT/E	Ballast dependent	50,000	3500K	1900	80+	>0.9	Plastic	24	5.1
41708	LED15PBG24QVDIM835SUB	15	G24Q/GX24Q	CF42DT/E	Ballast dependent	50,000	3500K	2000	80+	>0.9	Plastic	24	5.1
41709	LED15PBG24QHDIM841SUB	15	G24Q/GX24Q	CF42DT/E	Ballast dependent	50,000	4100K	1900	80+	>0.9	Plastic	24	5.1
41710	LED15PBG24QVDIM841SUB	15	G24Q/GX24Q	CF42DT/E	Ballast dependent	50,000	4100K	2000	80+	>0.9	Plastic	24	5.1
SubstiTUBE CCT Selectable													
41701	LED9.5PBG24QHDIM8SC1SUB	9.5	G24Q/GX24Q	CF26DD/E	Ballast dependent	50,000	3000K, 3500K, 4100K	960, 1020, 1050	80+	>0.9	Plastic	24	5.1
41702	LED9.5PBG24QVDIM8SC1SUB	9.5	G24Q/GX24Q	CF26DD/E	Ballast dependent	50,000	3000K, 3500K, 4100K	1100, 1120, 1150	80+	>0.9	Plastic	24	5.1
SubstiTUBE Omnidirectional													
41711	LED7PBG24QODIM827SUB	7	G24Q/GX24Q	CF18DD/E	Ballast dependent	50,000	2700K	820	80+	>0.9	Plastic	24	N/A
41712	LED7PBG24QODIM830SUB	7	G24Q/GX24Q	CF18DD/E	Ballast dependent	50,000	3000K	820	80+	>0.9	Plastic	24	N/A
41713	LED7PBG24QODIM835SUB	7	G24Q/GX24Q	CF18DD/E	Ballast dependent	50,000	3500K	820	80+	>0.9	Plastic	24	N/A
41714	LED7PBG24QODIM841SUB	7	G24Q/GX24Q	CF18DD/E	Ballast dependent	50,000	4100K	820	80+	>0.9	Plastic	24	N/A
41715	LED9.5PBG24QODIM827SUB	9.5	G24Q/GX24Q	CF26DD/E	Ballast dependent	50,000	2700K	1200	80+	>0.9	Plastic	24	N/A
41716	LED9.5PBG24QODIM830SUB	9.5	G24Q/GX24Q	CF26DD/E	Ballast dependent	50,000	3000K	1200	80+	>0.9	Plastic	24	N/A
41717	LED9.5PBG24QODIM835SUB	9.5	G24Q/GX24Q	CF26DD/E	Ballast dependent	50,000	3500K	1200	80+	>0.9	Plastic	24	N/A
41718	LED9.5PBG24QODIM841SUB	9.5	G24Q/GX24Q	CF26DD/E	Ballast dependent	50,000	4100K	1200	80+	>0.9	Plastic	24	N/A
Go to Page 8 for more SubstiTUBE Lamps													
LEDlescent™ High Output													
41695	LED15PBG24DH830BF	15	G24D/G24Q/GX24Q	CF42DT/E	120-277	50,000	3000K	1900	80+	>0.9	Plastic	24	N/A
41697	LED15PBG24DH835BF	15	G24D/G24Q/GX24Q	CF42DT/E	120-277	50,000	3500K	1900	80+	>0.9	Plastic	24	N/A
41699	LED15PBG24DH841BF	15	G24D/G24Q/GX24Q	CF42DT/E	120-277	50,000	4100K	1900	80+	>0.9	Plastic	24	N/A
41696	LED16PBG24DV830BF	16	G24D/G24Q/GX24Q	CF42DT/E	120-277	50,000	3000K	2000	80+	>0.9	Plastic	24	N/A
41698	LED16PBG24DV835BF	16	G24D/G24Q/GX24Q	CF42DT/E	120-277	50,000	3500K	2000	80+	>0.9	Plastic	24	N/A
41700	LED16PBG24DV841BF	16	G24D/G24Q/GX24Q	CF42DT/E	120-277	50,000	4100K	2000	80+	>0.9	Plastic	24	N/A
LEDlescent Ultra Thin													
42068	LED3.5PB2G7H827BF	3.5	2G7	CF7DS/8XX or CF9DS/8XX	120-277	50,000	2700K	330	80+	>0.9	Plastic	24	N/A
42069	LED3.5PB2G7H830BF	3.5	2G7	CF7DS/8XX or CF9DS/8XX	120-277	50,000	3000K	340	80+	>0.9	Plastic	24	N/A
42070	LED3.5PB2G7H835BF	3.5	2G7	CF7DS/8XX or CF9DS/8XX	120-277	50,000	3500K	350	80+	>0.9	Plastic	24	N/A
42071	LED3.5PB2G7H841BF	3.5	2G7	CF7DS/8XX or CF9DS/8XX	120-277	50,000	4100K	360	80+	>0.9	Plastic	24	N/A

*No DLC category for lamps with N/A

Ordering Information (continued)

Item Number	Ordering Abbreviation	Lamp Wattage (W)	Base Type	Replaces	Input Voltage (V)	Avg. Life (hrs)	CCT	Typical Lumens (lm)	CRI	Power Factor	Bulb Finish	Case Qty.	DLC Listed*
LEDlescent™ Ultra Thin (continued)													
42072	LED5.5PB2GX7H827BF	5.5	2GX7	CF13DS/8XX	120-277	50,000	2700K	550	80+	>0.9	Plastic	24	N/A
42073	LED5.5PB2GX7H830BF	5.5	2GX7	CF13DS/8XX	120-277	50,000	3000K	550	80+	>0.9	Plastic	24	N/A
42074	LED5.5PB2GX7H835BF	5.5	2GX7	CF13DS/8XX	120-277	50,000	3500K	570	80+	>0.9	Plastic	24	N/A
42075	LED5.5PB2GX7H841BF	5.5	2GX7	CF13DS/8XX	120-277	50,000	4100K	590	80+	>0.9	Plastic	24	N/A
DUALescent™ CCT Selectable													
41691	LED8.5PBG24DH8SC1AB	8.5	G24D/G24Q/GX24Q	CF26DD	Ballast dependent or 120-277	50,000	3000K, 3500K, 4100K	960, 1020, 1050	80+	>0.9	Plastic	24	N/A
41692	LED8.5PBG24DV8SC1AB	8.5	G24D/G24Q/GX24Q	CF26DD	Ballast dependent or 120-277	50,000	3000K, 3500K, 4100K	1100, 1120, 1150	80+	>0.9	Plastic	24	N/A
DUALescent Omnidirectional													
41719	LED7PBG24D0827AB	7	G24D/G24Q/GX24Q	CF18DD	Ballast dependent or 120-277	50,000	2700K	830	80+	>0.9	Plastic	24	N/A
41720	LED7PBG24D0830AB	7	G24D/G24Q/GX24Q	CF18DD	Ballast dependent or 120-277	50,000	3000K	880	80+	>0.9	Plastic	24	N/A
41721	LED7PBG24D0835AB	7	G24D/G24Q/GX24Q	CF18DD	Ballast dependent or 120-277	50,000	3500K	880	80+	>0.9	Plastic	24	N/A
41722	LED7PBG24D0841AB	7	G24D/G24Q/GX24Q	CF18DD	Ballast dependent or 120-277	50,000	4100K	900	80+	>0.9	Plastic	24	N/A
41723	LED9PBG24D0827AB	9	G24D/G24Q/GX24Q	CF26DD	Ballast dependent or 120-277	50,000	2700K	1150	80+	>0.9	Plastic	24	N/A
41724	LED9PBG24D0830AB	9	G24D/G24Q/GX24Q	CF26DD	Ballast dependent or 120-277	50,000	3000K	1200	80+	>0.9	Plastic	24	N/A
41725	LED9PBG24D0835AB	9	G24D/G24Q/GX24Q	CF26DD	Ballast dependent or 120-277	50,000	3500K	1250	80+	>0.9	Plastic	24	N/A
41726	LED9PBG24D0841AB	9	G24D/G24Q/GX24Q	CF26DD	Ballast dependent or 120-277	50,000	4100K	1250	80+	>0.9	Plastic	24	N/A
DUALescent Ultra Thin													
42060	LED3.5PBG23H827AB	3.5	G23	CF7DS/8XX or CF9DS/8XX	Ballast dependent or 120-277	50,000	2700K	330	80+	>0.9	Plastic	24	N/A
42061	LED3.5PBG23H830AB	3.5	G23	CF7DS/8XX or CF9DS/8XX	Ballast dependent or 120-277	50,000	3000K	340	80+	>0.9	Plastic	24	N/A
42062	LED3.5PBG23H835AB	3.5	G23	CF7DS/8XX or CF9DS/8XX	Ballast dependent or 120-277	50,000	3500K	350	80+	>0.9	Plastic	24	N/A
42063	LED3.5PBG23H841AB	3.5	G23	CF7DS/8XX or CF9DS/8XX	Ballast dependent or 120-277	50,000	4100K	360	80+	>0.9	Plastic	24	N/A
42064	LED5.5PBGX23H827AB	5.5	GX23	CF13DS/8XX	Ballast dependent or 120-277	50,000	2700K	550	80+	>0.9	Plastic	24	N/A
42065	LED5.5PBGX23H830AB	5.5	GX23	CF13DS/8XX	Ballast dependent or 120-277	50,000	3000K	550	80+	>0.9	Plastic	24	N/A
42066	LED5.5PBGX23H835AB	5.5	GX23	CF13DS/8XX	Ballast dependent or 120-277	50,000	3500K	570	80+	>0.9	Plastic	24	N/A
42067	LED5.5PBGX23H841AB	5.5	GX23	CF13DS/8XX	Ballast dependent or 120-277	50,000	4100K	590	80+	>0.9	Plastic	24	N/A

*No DLC category for lamps with N/A

Specifications & Lighting Data

Lamp	Ballast	Current (AMPS) (120V/277V)	System Power (W)	System Lumens (lm)*	System Efficacy (lm/W)	No of Lamps
LED15PBG24Q(HDIM8XXSUB	Type A	0.25/0.11	30	3800	127	2
LED15PBG24QVDIM8XXSUB	Type A	0.25/0.11	30	4000	133	2
LED15PBG24DH8XXBF	Type B	0.25/0.16	30	3800	137	2
LED16PBG24DV8XXBF	Type B	0.27/0.11	32	4000	125	2
LED9.5PBG24QHDIM8SC1SUB	Type A	0.08/0.03	9.5	1150	121	1
LED9.5PBG24QVDIM8SC1SUB	Type A	0.08/0.03	9.5	1200	126	1
LED8.5PBG24DH8SC1AB	Type AB	0.07/0.03	8.5	1050	124	1
LED8.5PBG24DV8SC1AB	Type AB	0.07/0.03	8.5	1150	135	1
LED7PBG24QODIM8XXSUB	Type A	0.06/0.03	7	820	117	1
LED9.5PBG24QODIM8XXSUB	Type A	0.08/0.03	9.5	1200	126	1
LED7PBG24D08XXAB	Type AB	0.06/0.03	7	820	117	1
LED9PBG24D08XXAB	Type AB	0.08/0.03	9	1200	133	1
LED3.5PBG23H8XXAB	Type AB	0.03/0.01	3.5	340	97	1
LED5.5PBGX23H8XXAB	Type AB	0.05/0.02	5.5	550	100	1
LED3.5PB2G7H8XXBF	Type B	0.03/0.01	3.5	340	97	1
LED5.5PB2GX7H8XXBF	Type B	0.05/0.02	5.5	550	100	1

*Lumen at 4100K CCT.

Physical Information

Lamp Description	Max. Overall Length inch (mm)	Base Face to Top of Lamp inch (mm)	Nominal lamp Diameter/Width inch (mm)	Guide Post Length inch (mm)
LED15PBG24QHDIM8XXSUB	6.65 (169)	6.04 (153.5)	1.77 (45)	0.61 (15.5)
LED15PBG24QVDIM8XXSUB	6.40 (162.5)	5.79 (147)	3.46 (88)	0.61 (15.5)
LED15PBG24DH8XXBF	6.65 (169)	6.04 (153.5)	1.77 (45)	0.61 (15.5)
LED16PBG24DV8XXBF	6.40 (162.5)	5.79 (147)	3.46 (88)	0.61 (15.5)
LED9.5PBG24QHDIM8SC1SUB	6.35 (161.4)	5.74 (145.9)	1.31 (33.2)	0.61 (15.5)
LED9.5PBG24QVDIM8SC1SUB	5.11 (130)	4.51 (114.5)	2.76 (70)	0.61 (15.5)
LED8.5PBG24DH8SC1AB	6.35 (161.4)	5.74 (145.9)	1.31 (33.2)	0.61 (15.5)
LED8.5PBG24DV8SC1AB	5.11 (130)	4.51 (114.5)	2.76 (70)	0.61 (15.5)
LED7PGG24QODIM8XXSUB	5.69 (144.5)	5.09 (129)	1.36 (34.5)	0.61 (15.5)
LED9.5PBG24QODIM8XXSUB	6.87 (174.5)	6.26 (159)	1.36 (34.5)	0.61 (15.5)
LED7PBG24D08XXAB	5.69 (144.5)	5.09 (129)	1.36 (34.5)	0.61 (15.5)
LED9PBG24D08XXAB	6.87 (174.5)	6.26 (159)	1.36 (34.5)	0.61 (15.5)
LED6PBGX238XX	6.77 (172)	6.18 (157)	1.06 (27)	0.59 (15)
LED3.5PBG23H8XXAB	5.28 (134)	4.49 (114)	1.26 (32)	0.79 (20)
LED5.5PBGX23H8XXAB	7.05 (179)	6.26 (159)	1.26 (32)	0.79 (20)
LED3.5PB2G7H8XXBF	4.74 (120.4)	4.49 (114)	1.46 (37)	N/A
LED5.5PB2GX7H8XXBF	6.51 (165.4)	6.26 (159)	1.46 (37)	N/A

7W Omnidirectional SubstiTUBE® and DUALescent™

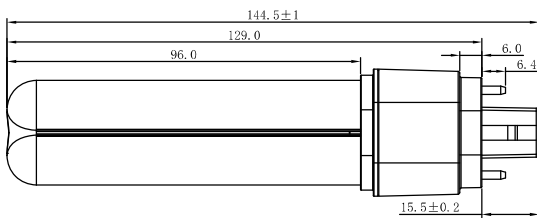

DUALescent UL Type A+B Base – G24d

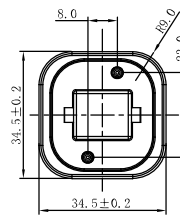

6W SubstiTUBE Base – GX23

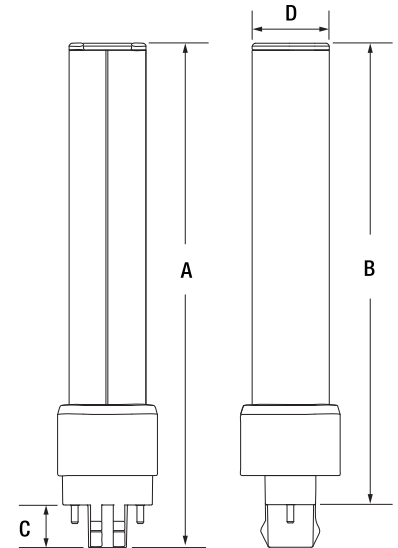

9W Omnidirectional SubstiTUBE and DUALescent

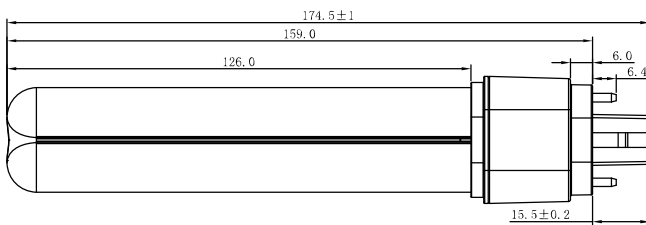

SubstiTUBE UL Type A Base – G24q

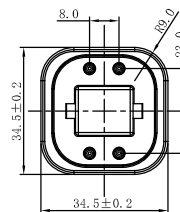

CCT Selectable UL Type A SubstiTUBE® and UL Type A+B DUALescent™ Horizontal

Front View

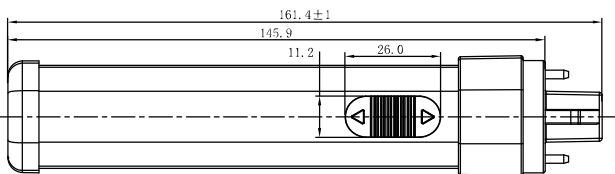

Side View

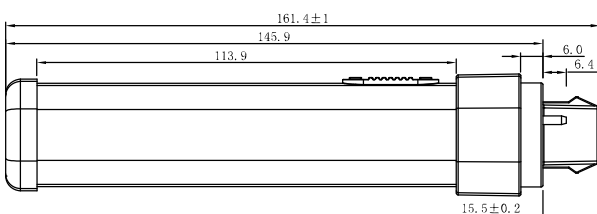

DUALescent UL Type A+B Base – G24d

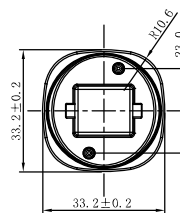

SubstiTUBE UL Type A Base – G24q

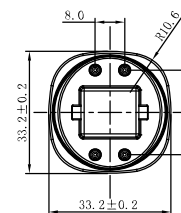

Dimensions in mm

Physical Information (continued)

CCT Selectable UL Type A SubstiTUBE and UL Type A+B DUALescent Vertical

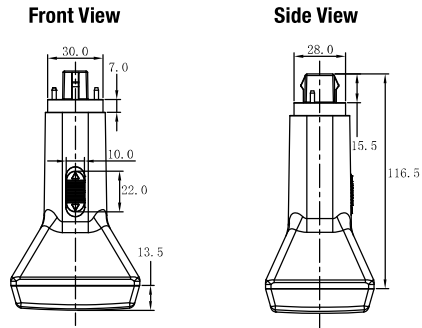

DUALescent UL Type A+B Base – G24d

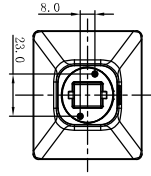

SubstiTUBE UL Type A Base – G24q

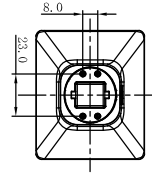

High Output UL Type A SubstiTUBE® and UL Type B LEDlescent™ Horizontal

Front View

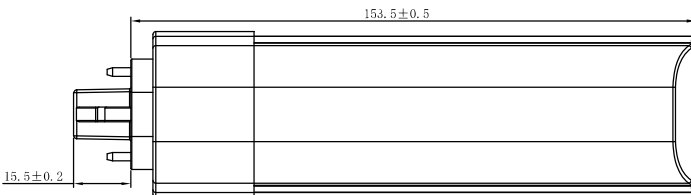

LEDlescent UL Type B Base – G24d

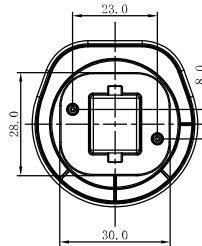

SubstiTUBE UL Type A Base – G24q

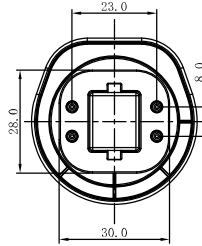

High Output SubstiTUBE UL Type A and LEDlescent UL Type B Horizontal

Side View

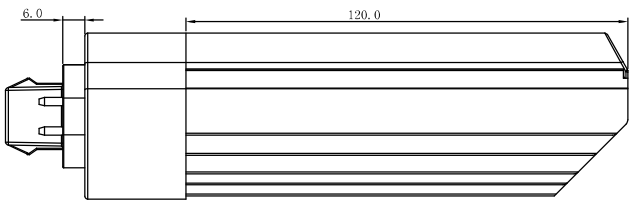

LEDlescent UL Type B Base – G24d

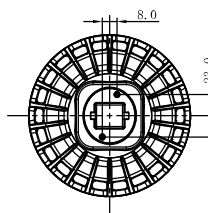

SubstiTUBE UL Type A Base – G24q

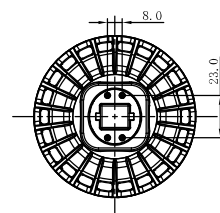

High Output SubstiTUBE UL Type A and LEDlescent UL Type B Vertical

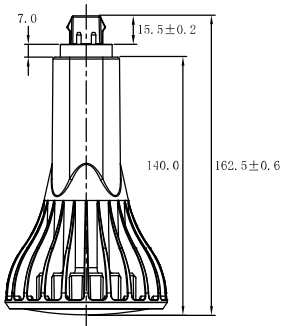

Physical Information (continued)

**LEDlescent™ Ultra Thin
for 2G7**

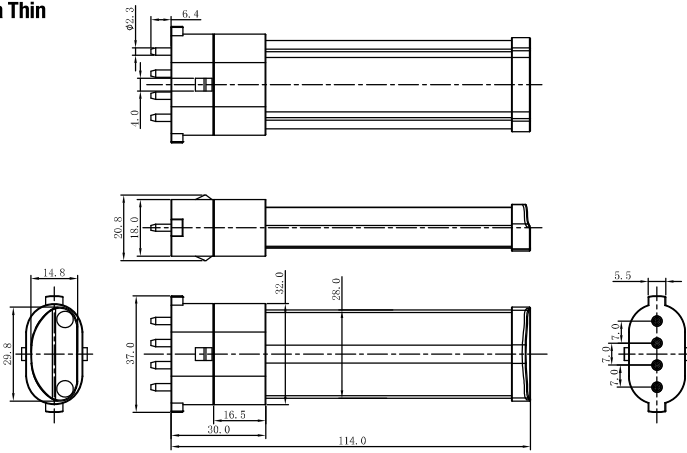

**LEDlescent UL Type B
Base – 2G7**

**LEDlescent Ultra Thin
for 2GX7**

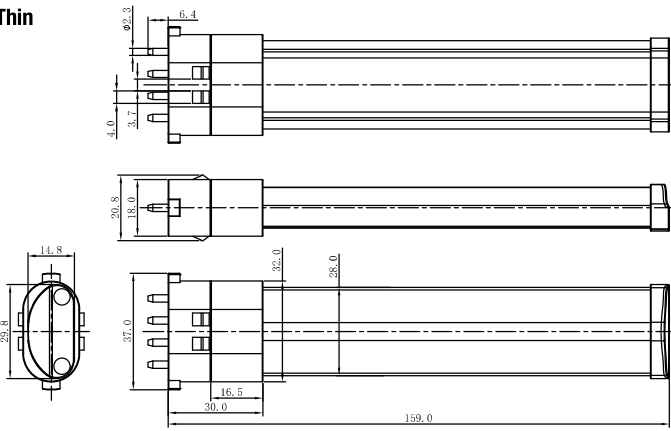

**LEDlescent UL Type B
Base – 2GX7**

**DUALescent™ Ultra Thin
for G23**

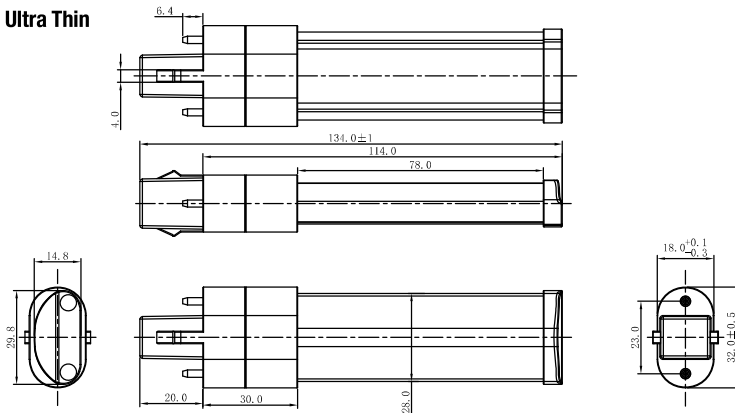

**DUALescent UL Type A+B
Base – G23**

**DUALescent™ Ultra Thin
for GX23**

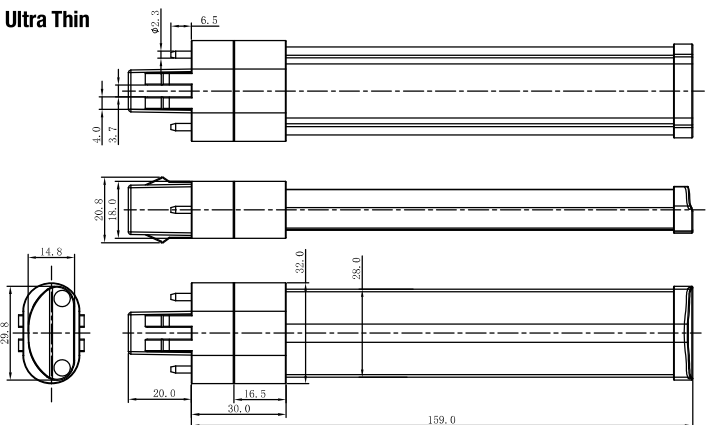

**DUALescent UL Type A+B
Base – GX23**

Dimensions in mm

Specifications

EMI/RFI: FCC Title 47 CFR, Part 18, Non-Consumer (GX24q) and Part 15, Class B (GX23)

Ordering Guide

LED	9	/	PB	/	GX24	/	H	/	8	35	G2
LED Lamp	Wattage		Pin Base		Base Type		Orientation		CRI= 80+	Color Temperature	Generation

Ordering Information

Item Number	Ordering Abbreviation	Configuration	Wattage	Lumens (lm)	CCT	CRI	DIM	DLC (Y/N)
40407*	LED16/PB/GX24Q/H/830	Horizontal	16W	1750	3000K	80	No	Y
40412*	LED16/PB/GX24Q/V/835	Vertical	16W	1750	3500K	80	No	Y
40413*	LED16/PB/GX24Q/V/841	Vertical	16W	1850	4100K	80	No	Y

*The above lamps will be phasing out with the introduction of our new portfolio. Upon depletion of inventory, the lamps will be obsolete.

Lamp Dimensions

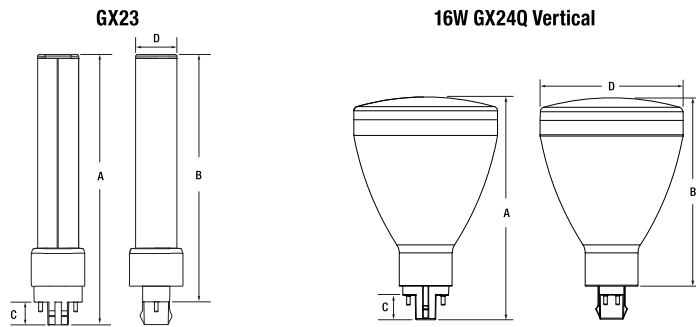

Ordering Abbreviation	(A) Max. Overall Length	(B) Base Face to Top of Lamp	(C) Guide Post Length	(D) Max. Base Width (Front)	(E) Max. Base Width (Side)
GX23	6.77" (172mm)	6.18" (157mm)	.59" (15mm)	1.06" (27mm)	
16W GX24Q Vertical	5.81" (147.5mm)	5.18" (131.5mm)	.63" (16mm)	3.74" (95mm)	N/A

LEDVANCE LLC
 181 Ballardvale Street, Suite 203
 Wilmington, MA 01887 USA
 Phone 1-800-LIGHTBULB (1-800-544-4828)
 www.ledvanceUS.com

SYLVANIA and LEDVANCE are registered trademarks.
 All other trademarks are those of their respective owners.
 Licensee of product trademark SYLVANIA in general lighting.
 Specifications subject to change without notice.



SCAN TO FOLLOW US
 ON SOCIAL MEDIA