

SYLVANIA Luminaires

Hi-PerformanceLED™ Downlight Gimbal

Application

The SYLVANIA Hi-PerformanceLED Downlight Gimbal is a new generation of slim luminaires oriented to provide accent lighting, thanks to its narrow beam angle (45°). Offering energy savings up to 88% and excellent high color rendering (CRI 90), you may select the preferred brightness thanks to its phase-cut dimming which ranges from 10% to 100%. This luminaire is designed for residential, hospitality, retail or any low bay application.

Benefits and Features

- Modern styling and slim form provide an update from traditional designs
- Phase-cut dimmable
- High color rendering (CRI >90)
- Beam angle 45°
- Tilting lenses 90°
- Up to 79 LPW
- 5 CCT selectable
- Offered in 7, 9 or 13 watts
- Uniform, glare free illumination
- Wet rated
- Energy savings up to 88%

Electrical

- 120V_{AC}
- Power Factor >0.9

Rated Life

- 50,000 hours (L₇₀)

Warranty

- 5-year
- NLB Trusted Warranty Program

Operating Temperature

- -4°F to +104°F (-20°C to +40°C)

Item #
Type
Project
Notes
Date



Wattage Comparison

Traditional Source	Traditional System Wattage	LED System Wattage	Energy Savings
Fluorescent	60W	7W	Up to 88%
Fluorescent	65W	9W	Up to 86%
Fluorescent	75W	13W	Up to 83%

Certifications and Listings

- cETLus
- RoHS
- FCC
- ENERGY STAR®
- T24
- IC rated

Installation

- Hardwire
- Ceiling cut out sizes:
 - 3": 3.3" (85mm)
 - 4": 4" (102mm)
 - 5": 5" (128mm)



Ordering Guide

LEDRT	X	G	XXXX	SC3
Product Name	Size	Lamp Type	Lumens	Selectable Color Temperature
LEDRT = LED	3 = 3in	G = Gimbal	550 = 550lm	2700K, 3000K, 3500K, 4000K or 5000K
Retrofit Downlight	4 = 4in		650 = 650lm	
	6 = 6in		1000 = 1000lm	

Ordering Information

Item Number	Ordering Abbreviation	Power (W)	Input Voltage (V)	Base Type	Replaces	Average Rated Life (hrs.)	CCT	Total Lumens (lm)	CRI	Power Factor	Bulb Finish	ENERGY STAR®	T24
62392	LEDRT3G550SC3	7	120	Hardwire	60W	50,000	2700/3000/3500/4000/5000K	550	>90	>90	Frosted	Yes	Yes
62393	LEDRT4G650SC3	9	120	Hardwire	65W	50,000	2700/3000/3500/4000/5000K	650	>90	>90	Frosted	Yes	Yes
62394	LEDRT6G1000SC3	13	120	Hardwire	75W	50,000	2700/3000/3500/4000/5000K	1000	>90	>90	Frosted	Yes	Yes

Energy Savings

Basic Product Description	LED Life (hrs)	LED Lumens	Similar Incandescent	Incandescent Lumens	Watts Saved	Energy Savings*	LED Life vs Incandescent
LEDRT3G550SC3	50,000	550lm	2000	600	53	\$292	25x
LEDRT4G650SC3	50,000	650lm	2000	700	56	\$308	25x
LEDRT6G1000SC3	50,000	1000lm	2000	900	62	\$341	25x

*Energy savings over life of lamp calculated at \$0.11/kWh

Photometric Information

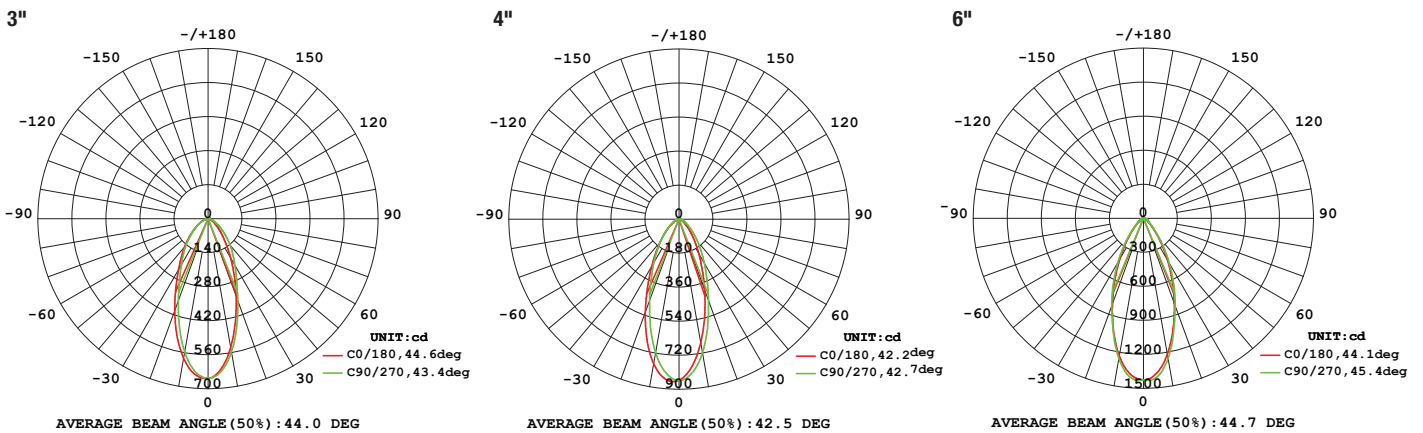

Physical Information

Lamp Description	Height (in)	Diameter (in)
LEDRT3G650SC3	1.14	4.1
LEDRT4G650SC3	1.18	4.72
LEDRT6G1000SC3	1.53	6.14

3"

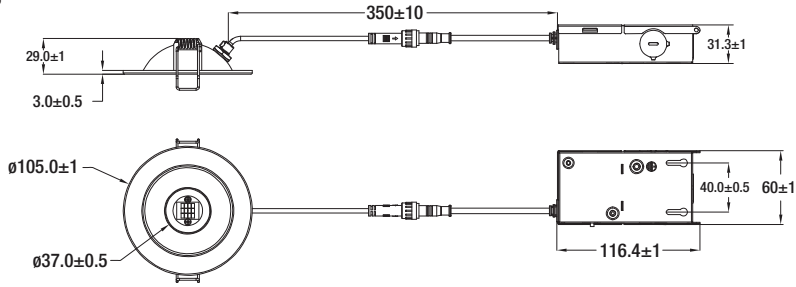

4"

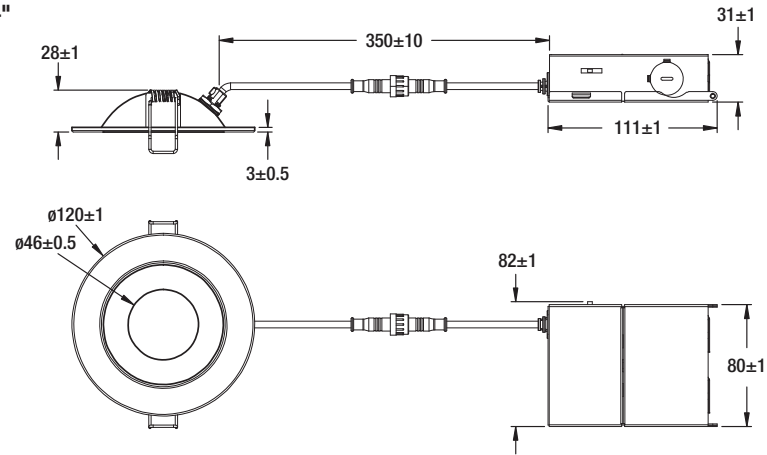

6"

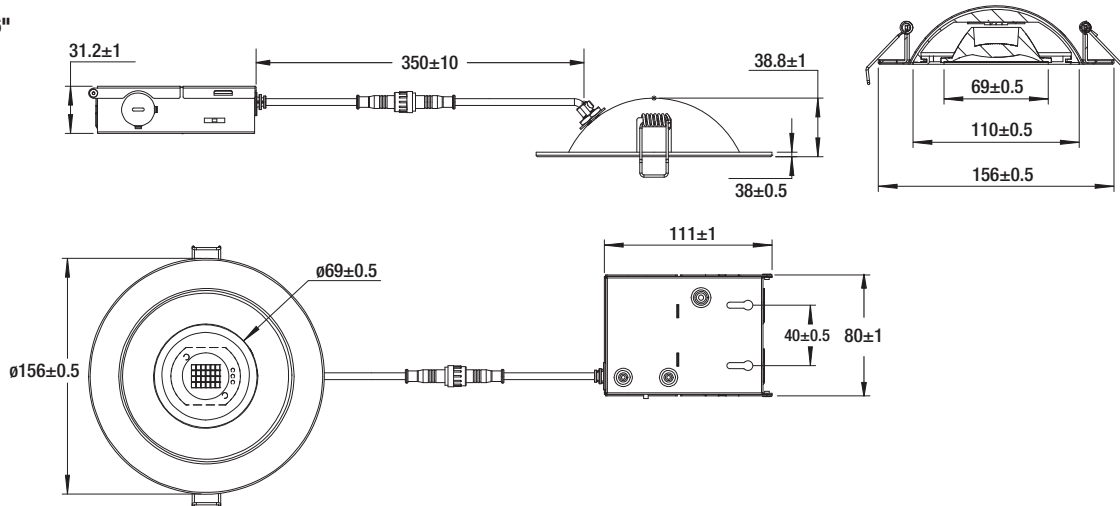

Hole Cut Templates

RT3 Hole Cut Template

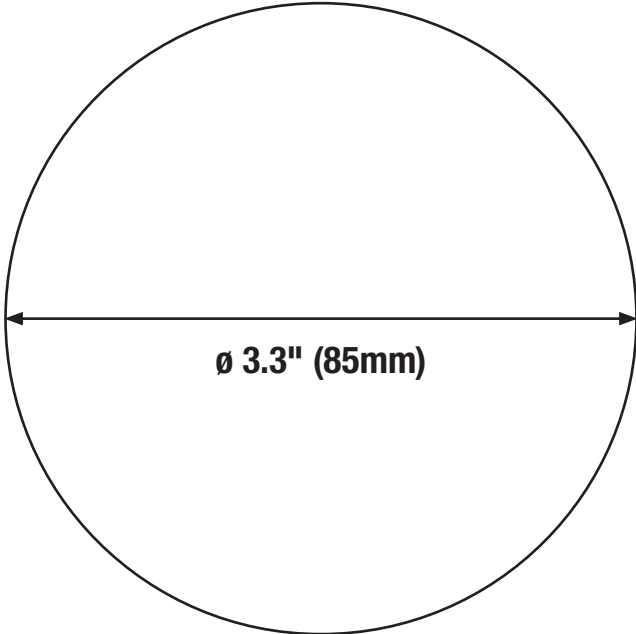

RT4 Hole Cut Template

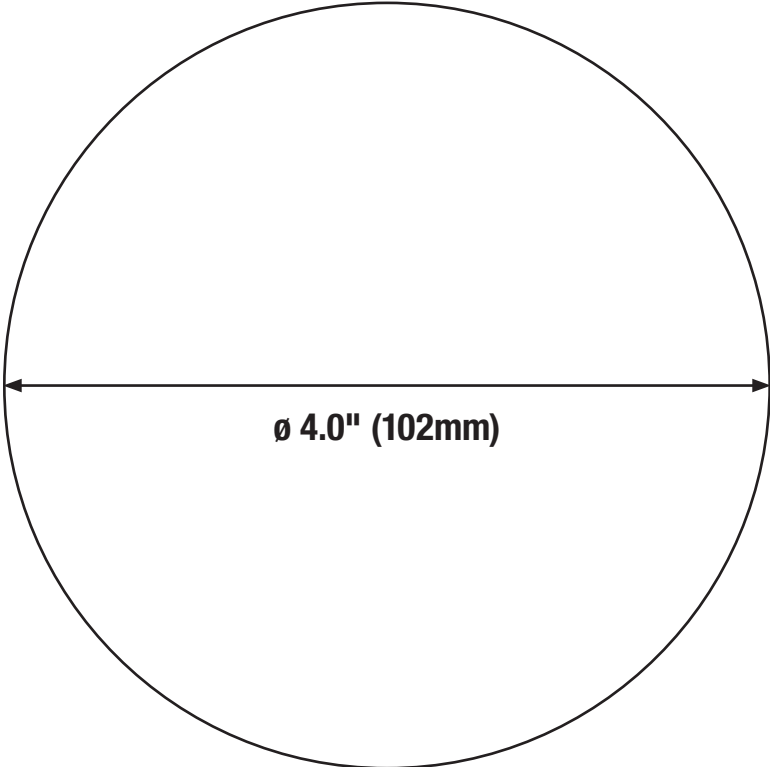

Hole Cut Templates

RT6 Hole Cut Template

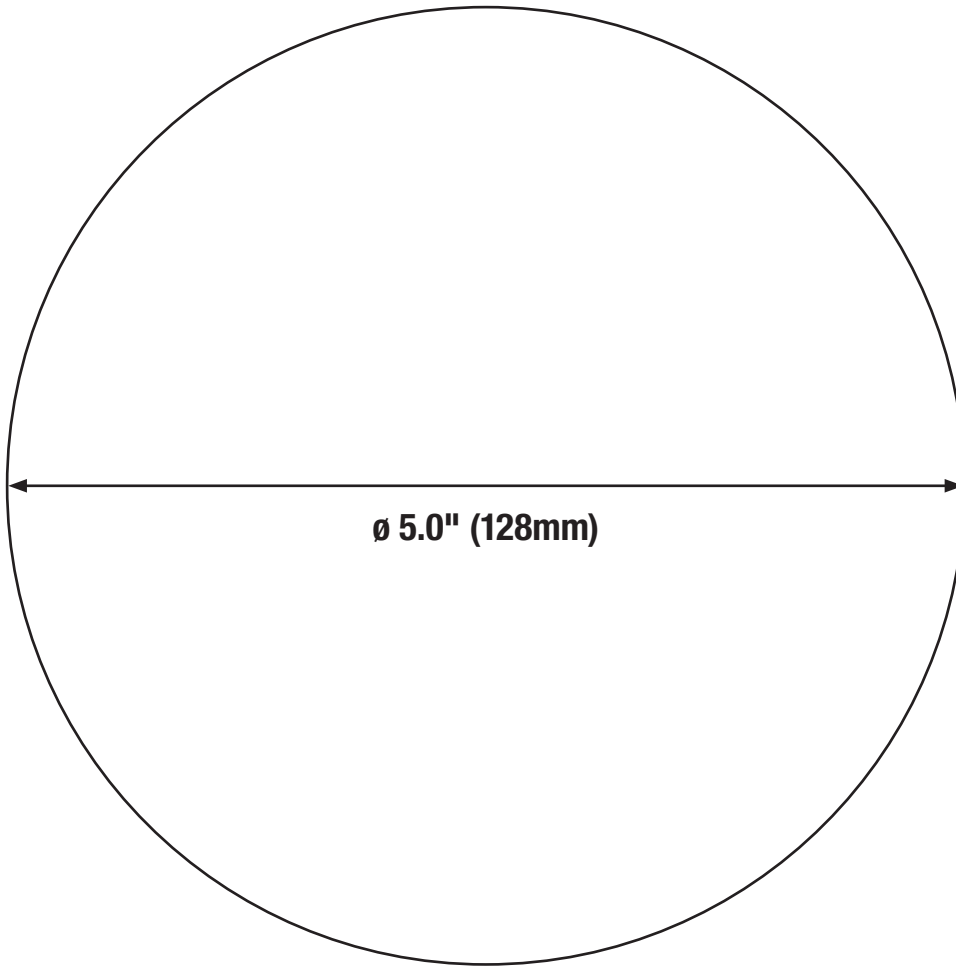

LEDVANCE LLC
200 Ballardvale Street
Wilmington, MA 01887 USA
Phone 1-800-LIGHTBULB (1-800-544-4828)
www.ledvanceUS.com

SYLVANIA and LEDVANCE are registered trademarks.
All other trademarks are those of their respective owners.
Licensee of product trademark SYLVANIA in general lighting.
Specifications subject to change without notice.

 /sylvania  /sylvania

Name: _____

Email: _____

Phone: _____

