

# H & M Distributors

Click below to order

Interlight Specialty Bulbs  
1-800-743-0005  
[www.interlight.biz](http://www.interlight.biz)



H & M Distributors, Inc.  
1009 Industrial Road  
Boulder City, NV 89005

phn: 1.888.203.6360  
fax: 1.702.294.8946

[www.hmlighting.com](http://www.hmlighting.com)

## Identification Guide

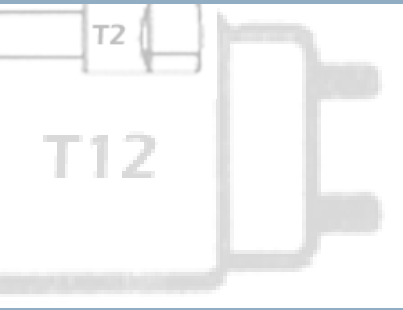
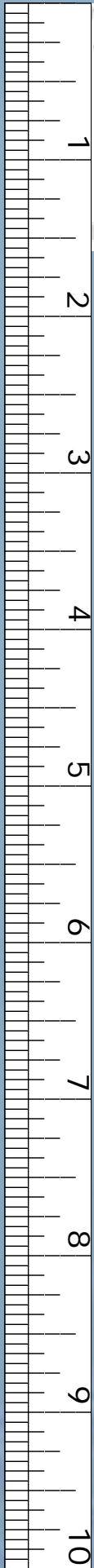

**Lamp diameters are measured in eighths of an inch**

**Linear Fluorescent**

- T2** 2/8" (1/4" in diameter)
- T4** 4/8" (1/2" in diameter)
- T5** 5/8" (5/8" in diameter)
- T6** 6/8" (3/4" in diameter)
- T8** 8/8" (1" in diameter)
- T10** 10/8" (1 1/4" in diameter)
- T12** 12/8" (1 1/2" in diameter)

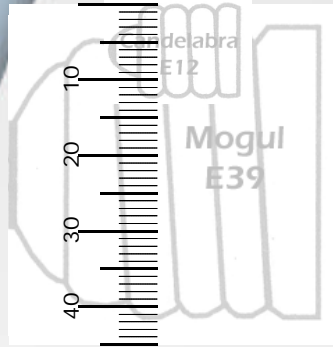

**Lamp base diameters are measured in mm's**

**Incandescent**

<b>Candelabra base</b>	E12	12mm
<b>Intermediate base</b>	E17	17mm
<b>Medium base</b>	E26/E27	26-27mm
<b>Mogul base</b>	E39	39mm

Click below to order

Interlight Specialty Bulbs  
 1-800-743-0005  
[www.interlight.biz](http://www.interlight.biz)





Click below to order

Interlight Specialty Bulbs  
1-800-743-0005  
[www.interlight.biz](http://www.interlight.biz)

## Visit Us On The Web

# [www.hmlighting.com](http://www.hmlighting.com)

At H & M Distributors, Inc., we offer our customers a unique and simplified way to the right products. Our Web Site, [www.hmlighting.com](http://www.hmlighting.com) has categorized product sections which allow our customers to easily select the proper product for their needs

Customers can also simply cross reference our products. Simply go to the main product category of the product you wish to cross reference and the select the manufacturers brand you wish to cross over to ours.

Besides offering a great way to cross other manufacturers products with ours, our Web site also offers the following:

- Find a distributor in your area who offers H&M products
- Download a copy of the H&M Catalog in PDF format
- Customer support, including telephone, email and address information

H&M's Web site offers complete information on all of our lamps, ballasts, emergency lighting, lampholders, case cords and fixtures. Next time you're on the internet, check us out!

Click below to order

Interlight Specialty Bulbs  
1-800-743-0005  
[www.interlight.biz](http://www.interlight.biz)

# Table of Contents

<b>LINEAR FLUORESCENT LAMPHOLDERS</b>	<b>6 - 10</b>
BiPin Lampholders	6-8
Slimline Lampholders	8-9
HO & VHO Lampholders	9-10
Miscellaneous Fluorescent Parts	10
<b>CFL LAMPHOLDERS</b>	<b>13 - 22</b>
2-pin CFL Lampholders	13-16
4-pin CFL Lampholders	18-22
<b>INCANDESCENT LAMPHOLDERS</b>	<b>24 - 25</b>
<b>H.I.D. LAMPHOLDERS</b>	<b>28 - 29</b>
<b>HALOGEN LAMPHOLDERS</b>	<b>32 - 33</b>
<b>MISCELLANEOUS LAMPHOLDER COMPONENTS</b>	<b>34</b>
<b>CASE CORDS</b>	<b>36 - 38</b>
2-pin	36
3-pin	36 - 37
4-pin	37
5-pin	37 - 38
7-pin	38
Combination cords	38
<b>UNDERCABINET FIXTURES</b>	<b>42 - 46</b>
Antares fixtures & accessories	42 - 43
Hera fixtures & accessories	44 - 45
Sunpark fixtures & accessories	46
<b>ELECTRONIC FREEZER BALLASTS</b>	<b>47 - 50</b>
<b>WORKHORSE BALLASTS</b>	<b>51 - 63</b>

Click below to order

Interlight Specialty Bulbs  
1-800-743-0005  
[www.interlight.biz](http://www.interlight.biz)

# Linear Fluorescent Lampholders



T2  
Subminiature  
W4.3 / Axial base



T4 / T5  
Miniature BiPin  
G5 base



T8  
Medium BiPin  
G13 base



T10  
Medium BiPin  
G13 base



T12  
Medium BiPin  
G13 base



T6  
Slimline/Single  
pin  
Fa8 base



T8  
Slimline/Single  
pin  
Fa8 base



T12  
Slimline/Single  
pin  
Fa8 base

T2 = 2/8" (1/4" diameter)  
T4 = 4/8" (1/2" diameter)  
T5 = 5/8" (5/8" diameter)  
T6 = 6/8" (3/4" diameter)  
T8 = 8/8" (1" diameter)  
T10 = 10/8" (1 1/4" diameter)  
T12 = 12/8" (1 1/2" diameter)

Linear fluorescent lamps "T" designations indicate that the lamps are "tubular" and what their diameter is in eighths of an inch.



T8  
HO - RDC  
R17d base



T10  
1500ma - RDC  
R17d base



T12  
HO/VHO - RDC  
R17d base

Section	Page(s)
BiPin Lampholders	6 - 8
Slimline Lampholders	8 - 9
HO & VHO Lampholders	9 - 10
Miscellaneous Fluorescent Parts	10

T2 Subminiature Lampholders

<b>T2 Subminiature</b>	<b>LH0413</b> Ht = 9/16" Width = 9/16"	<b>LH0545</b> Ht = 9/16" Width = 9/16" Snap in	<b>LH0589</b> Ht = 9/16" Width = 9/16" Screw down	<b>LH0546</b> Discontinued	<b>T2 Subminiature</b>

T4/T5 Miniature Bipin Lampholders

<b>T4/T5 Miniature BiPin</b>		<b>LH0012</b> Ht = 13/16" Width = 3/4"	<b>LH0023</b> Ht = 1" Width = 7/8"	<b>LH0070</b> Ht = 15/16" Width = 13/16"	<b>LH0069</b> Ht = 11/16" Width = 1 5/16"	<b>LH0011</b> Ht = 1 5/16" Width = 5/8" Bracket has rivet hole	<b>LH0013</b> Ht = 1 3/8" Width = 3/4"	<b>LH0014</b> Ht = 7/8" Width = 3/4" 6-32 tapped hole	<b>T4/T5 Miniature BiPin</b>	
<b>LH0297</b> Ht = 11/16" Width = 5/8" Discontinued use LH0541	<b>LH0541</b> Ht = 11/16" Width = 5/8" Bracket has rivet hole	<b>LH0344</b> Ht = 13/16" Width = 3/4"	<b>LH0396</b> Ht = 7/8" Width = 3/4"	<b>LH0022</b> Ht = 7/8" Width = 5/8" Bracket has rivet hole	<b>LH0020</b> Discontinued	<b>LH0018</b> Ht = 1 1/16" Width = 13/16"	<b>LH0527</b> Ht = 1" Width = 7/8"	<b>LH0099</b> Ht = 1 1/4" Width = 7/8"	<b>LH0021</b> Ht = 13/16" Width = 15/16"	<b>LH0015</b> Ht = 1 1/4" Width = 7/8"
<b>LH0019</b> Ht = 1 1/4" Width = 3/4"	<b>LH0017</b> Ht = 1 1/2" Width = 7/8"	<b>LH0016</b> Ht = 1 7/16" Width = 7/8"	<b>LH0556</b> Ht = 1" Width = 1 1/8"	<b>LH0524</b> Ht = 1 3/16" Width = 15/16"	<b>LH0585</b> Ht = 1 7/16" Width = 1 3/16" T8/T12 to T5 adapter					













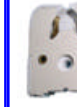







T8 Medium Bipin Lampholders (only)

<b>T8 (only) Medium BiPin</b>	<b>LH0100</b> Ht = 1 1/2" Width = 1"	<b>LH0064</b> Ht = 1 1/2" Width = 1"	<b>LH0364</b> Ht = 1 1/2" Width = 1 1/4" Flat back Cap LH0358	<b>LH0365</b> Ht = 1 1/2" Width = 1 5/16" Flat back Cap LH0358	<b>LH0101</b> Ht = 1 1/8" Width = 1 1/4" Cap LH0338	<b>LH0033</b> Ht = 1 3/8" Width = 1 3/16"	<b>LH0510</b> Ht = 1 3/8" Width = 1 1/8" Shunted	<b>T8 (only) Medium BiPin</b>		
<b>LH0107</b> Ht = 1 3/8" Width = 1 1/8"	<b>LH0490</b> Ht = 1 3/8" Width = 1 1/8" Shunted	<b>LH0034</b> Ht = 1 3/8" Width = 1"	<b>LH0491</b> Ht = 1 3/8" Width = 1" Shunted	<b>LH0084</b> Ht = 1 1/2" Width = 1"	<b>LH0074</b> Ht = 1 3/8" Width = 1 1/8"	<b>LH0081</b> Ht = 1 1/16" Width = 1"	<b>LH0482</b> Ht = 1 1/16" Width = 1 5/16"	<b>LH0483</b> Ht = 1 1/16" Width = 1 5/16" With Spring	<b>LH0343</b> Ht = 1 9/16" Width = 1 1/4"	<b>LH0007</b> Ht = 1 9/16" Width = 1 1/4" Shunted
<b>LH0040</b> Ht = 1 1/2" Width = 1 1/4" Shunted	<b>LH0039</b> Ht = 1 1/2" Width = 1 1/4"	<b>LH0049</b> Ht = 1 5/16" Width = 1 1/8"	<b>LH0513</b> Ht = 1 13/16" Width = 1 1/8" T12 stop	<b>LH0352</b> Ht = 1 5/8" Width = 1" Tapped mtg hole	<b>LH0353</b> Ht = 1 5/8" Width = 1" Tapped mtg hole	<b>LH0055</b> Ht = 1 9/16" Width = 1"	<b>LH0387</b> Ht = 1 1/2" Width = 1"	<b>LH0484</b> Ht = 1 1/4" Width = 1 1/8"	<b>LH0485</b> Ht = 1 1/4" Width = 1 1/8" Shunted	<b>LH0362</b> Ht = 1 3/4" Width = 1 5/16"

T8 Medium Bipin Lampholders (only) (cont.)

					
<b>LH0108</b> Discontinued use LH0362	<b>LH0110</b> Discontinued use LH0362	<b>LH0111</b> Discontinued use LH0362	<b>LH0112</b> Discontinued use LH0362	<b>LH0113</b> Discontinued use LH0362	<b>LH0083</b> Ht = 1 1/8" Width = 1 1/8"

T8/T10/T12 Medium Bipin Lampholders

												
<b>T8 / T10 / T12 Medium BiPin Lampholders</b>			<b>LH0284</b> Ht = 1 1/2" Width = 1"	<b>LH0283</b> Ht = 1 1/2" Width = 1"	<b>LH0050</b> Ht = 1 1/16" Width = 2 7/8"	<b>LH0058</b> Ht = 1 1/16" Width = 2 7/8"	<b>LH0010</b> Ht = 1 1/4" Width = 1 1/4"	<b>LH0114</b> Ht = 1 1/16" Width = 1 1/4" 4/36 tapped holes	<b>LH0347</b> Ht = 1 1/16" Width = 1 1/4" Spring clips on back	<b>T8 / T10 / T12 Medium BiPin Lampholders</b>		
												
<b>LH0051</b> Ht = 1 5/8" Width = 1 3/8" Ctr hole tapped for #6-32 screw	<b>LH0060</b> Ht = 1 3/8" Width = 1 5/8" Ctr hole tapped for #6-32 screw	<b>LH0115</b> Ht = 1 9/16" Width = 1 3/8" Ctr hole tapped for #6-32 screw	<b>LH0004</b> Ht = 1 5/8" Width = 1 1/2" Untapped ctr hole	<b>LH0003</b> Ht = 1 7/16" Width = 1 3/8" 1/8" ctr hole	<b>LH0486</b> Ht = 1 7/16" Width = 1 3/8" Ctr hole tapped for #6-32 screw	<b>LH0539</b> Ht = 1 1/2" Width = 1 3/8" Untapped ctr hole	<b>LH0562</b> Ht = 1 1/2" Width = 1 1/2" Untapped ctr hole	<b>LH0498</b> Ht = 1 1/2" Width = 1 3/8"	<b>LH0089</b> Ht = 1 13/16" Width = 1 3/16"	<b>LH0090</b> Ht = 1 13/16" Width = 1 3/16"	<b>LH0051</b> Ht = 1 5/8" Width = 1 3/8" Ctr hole tapped for #6-32 screw	<b>LH0090</b> Ht = 1 13/16" Width = 1 3/16"
												
<b>LH0056</b> Ht = 2 1/16" Width = 1"	<b>LH0495</b> Ht = 2 1/16" Width = 1" Ctr hole tapped for #8-32	<b>LH0086</b> Ht = 2 1/16" Width = 1"	<b>LH0054</b> Ht = 1 13/16" Width = 1 3/16"	<b>LH0538</b> Ht = 2 1/16" Width = 1 1/4"	<b>LH0025</b> Ht = 2 1/16" Width = 1 1/4"	<b>LH0059</b> Ht = 2 3/8" Width = 15/16"	<b>LH0031</b> Ht = 1 1/2" Width = 1 1/8" With stop	<b>LH0511</b> Ht = 1 1/2" Width = 1 3/8" With stop Shunted	<b>LH0032</b> Ht = 1 1/2" Width = 1 1/8" Without stop	<b>LH0514</b> Ht = 1 1/2" Width = 1 1/8" Without stop Shunted	<b>LH0032</b> Ht = 1 1/2" Width = 1 1/8" Without stop	<b>LH0514</b> Ht = 1 1/2" Width = 1 1/8" Without stop Shunted
												
<b>LH0029</b> Ht = 1 13/16" Width = 1 1/8" With stop	<b>LH0500</b> Ht = 1 13/16" Width = 1 1/8" With stop Shunted	<b>LH0030</b> Ht = 1 13/16" Width = 1 1/8" Without stop	<b>LH0501</b> Ht = 1 13/16" Width = 1 1/8" Without stop Shunted	<b>LH0357</b> Ht = 1 1/2" Width = 1 1/8" With stop Shunted	<b>LH0087</b> Ht = 1 15/16" Width = 1 1/4"	<b>LH0024</b> Ht = 1 5/8" Width = 1 1/4"	<b>LH0035</b> Ht = 1 5/8" Width = 1 1/4"	<b>LH0547</b> Ht = 1 5/8" Width = 1 1/4" Disconnect	<b>LH0519</b> Ht = 1 5/8" Width = 1 1/4"	<b>LH0394</b> Ht = 1 5/8" Width = 1 1/4" Shunted	<b>LH0029</b> Ht = 1 13/16" Width = 1 1/8" With stop	<b>LH0394</b> Ht = 1 5/8" Width = 1 1/4" Shunted
												
<b>LH0044</b> Ht = 1 11/16" Width = 1 1/4" Can be used to replace LH0034, 24, 61 & 532	<b>LH0492</b> Ht = 1 1/4" Width = 1 1/4" Disconnect	<b>LH0532</b> Ht = 1 5/8" Width = 1 1/4"	<b>LH0061</b> Ht = 1 11/16" Width = 1 1/8"	<b>LH0045</b> Ht = 2" Width = 1 1/4" Can be used to replace LH0026 & 27	<b>LH0026</b> Ht = 2" Width = 1 3/8"	<b>LH0027</b> Ht = 2" Width = 1 1/4"	<b>LH0052</b> Ht = 2" Width = 1 1/4"	<b>LH0294</b> Ht = 2 1/8" Width = 1 3/8" Disconnect	<b>LH0093</b> Ht = 2 1/8" Width = 1 3/8"	<b>LH0094</b> Ht = 2 1/8" Width = 1 3/8"	<b>LH0044</b> Ht = 1 11/16" Width = 1 1/4" Can be used to replace LH0034, 24, 61 & 532	<b>LH0094</b> Ht = 2 1/8" Width = 1 3/8"
												
<b>LH0116</b> Ht = 2 3/8" Width = 1 7/16"	<b>LH0006</b> Ht = 1 1/16" Width = 1 1/4"	<b>LH0008</b> Ht = 1 1/16" Width = 1"	<b>LH0488</b> Ht = 1 1/16" Width = 1 3/8" 9/16" thick	<b>LH0361</b> Ht = 1 1/16" Width = 1 1/4" 11/16" thick	<b>LH0009</b> Ht = 1 9/16" Width = 1 9/16" Not available in USA	<b>LH0073</b> Ht = 1 1/4" Width = 1 1/4"	<b>LH0072</b> Ht = 1 1/4" Width = 1 1/8"	<b>LH0071</b> Ht = 1 1/4" Width = 1 1/8"	<b>LH0078</b> Ht = 1 7/16" Width = 1 3/16"	<b>LH0077</b> Ht = 1 7/16" Width = 1"	<b>LH0116</b> Ht = 2 3/8" Width = 1 7/16"	<b>LH0077</b> Ht = 1 7/16" Width = 1"

T8/T10/T12 Medium Bipin Lampholders (cont.)

<b>LH0076</b> Ht = Width = 1 1/16"	<b>LH0075</b> Ht = Width = 1 1/4"	<b>LH0037</b> Ht = 1 15/16" Width = 1 1/8"	<b>LH0587</b> Ht = Width = 1 1/8"	<b>LH0370</b> Ht = 1 15/16" Width = 1" Shunted	<b>LH0385</b> Ht = 1 15/16" Width = 1 3/16"	<b>LH0038</b> Ht = 1 15/16" Width = 1"	<b>LH0048</b> Ht = 1 9/16" Width = 1 1/4"	<b>LH0477</b> Ht = 1 13/16" Width = 1" Shunted	<b>LH0537</b> Ht = 1 9/16" Width = 1 1/8" Shunted	<b>LH0489</b> Ht = 1 3/8" Width = 1 1/4"
<b>LH0521</b> Ht = 1 9/16" Width = 7/8"	<b>LH0042</b> Ht = 1 9/16" Width = 1 1/8"	<b>LH0571</b> Ht = 1 1/2" Width = 1 1/8"	<b>LH0047</b> Ht = 1 3/4" Width = 1 1/4"	<b>LH0567</b> Ht = Width = 1 3/16"	<b>LH0041</b> Ht = 1 1/2" Width = 1 1/8"	<b>LH0036</b> Ht = 1 1/2" Width = 1 1/8"	<b>LH0005</b> Ht = 1 5/16" Width = 7/8"	<b>LH0065</b> Ht = 1 1/16" Width = 1 1/8"	<b>LH0068</b> Ht = 1" Width = 1"	<b>LH0355</b> Ht = 1 5/8" Width = 1 1/4"
<b>LH0046</b> Ht = 1 5/8" Width = 1 7/8"	<b>LH0085</b> Ht = 1 13/16" Width = 1 3/8"	<b>LH0092</b> Ht = 1 9/16" Width =	<b>LH0043</b> Ht = 1 9/16" Width = 1 1/4"	<b>LH0028</b> Ht = 1 5/8" Width = 1 1/4"	<b>LH0102</b> Ht = 1 7/8" Width = 1 5/16" "U-back" Use cap LH0371	<b>LH0103</b> Ht = 1 7/16" Width = 1 1/4" "Flat back" Use Cap LH0358(T8) LH0339(T12)	<b>LH0104</b> Ht = 1 7/16" Width = 1 1/4" "Flat back" Use Cap LH0358(T8) LH0339(T12)	<b>LH0105</b> Ht = 1 7/16" Width = 1 1/4" "U-back" Use Cap LH0340(T8) LH0341(T12) LH0359(Arctic)	<b>LH0106</b> Ht = 1 7/16" Width = 1 1/4" "U-back" Use Cap LH0340(T8) LH0341(T12) LH0359(Arctic)	<b>LH0474</b> Ht = 2 3/8" Width = 1 11/16" "U-back" Use Cap LH0340(T8) LH0341(T12)
<b>LH0475</b> Ht = 2 5/8" Width = 1 11/16" "U-back" Use Cap LH0340(T8) LH0341(T12)	<b>LH0079</b> Ht = 2" Width = 1 5/8" With spring	<b>LH0080</b> Ht = 1 13/16" Width = 1 5/8"	<b>LH0097</b> Ht = 2 3/8" Width = 2 3/8"	<b>LH0098</b> Ht = 2 3/8" Width = 2 3/8"	<b>LH0062</b> Ht = 1 1/8" Width = 1 1/8"	<b>LH0063</b> Ht = 1 1/8" Width = 1 1/8"	<b>LH0067</b> Ht = 1 3/8" Width = 2"	<b>LH0066</b> Ht = 1 3/8" Width = 2"	<b>LH0117</b> Ht = 2 1/16" Width = 1 7/16"	<b>LH0118</b> Ht = 2 1/16" Width = 1 7/16"
<b>LH0348</b> Ht = 2 9/16" Width = 1 5/16"	<b>LH0349</b> Ht = 2 9/16" Width = 1 5/16"	<b>LH0350</b> Ht = 2 1/16" Width = 1 1/8"	<b>LH0351</b> Ht = 2 1/16" Width = 1 1/8"	<b>LH0082</b> Ht = 1 5/8" Width = 1 5/8"	<b>LH0335</b> Ht = 2 1/4" Width = 1 13/16" Screw ring for T8 lamps LH0317 for T12 LH0588	<b>LH0383</b> Ht = 1 5/8" Width = 2 9/16"	<b>LH0570</b> Ht = 3" Width = 9"	<b>LHB0042</b> Ht = Width = Anthony door bracket	<b>LHB0063</b> Ht = 1/2" Width = 1 3/16"	<b>LHB0062</b> Ht = 1 15/16" Width = 1 3/16"

T6/T8/T12 Single Pin Lampholders

<b>T6/T8/T12 Slimline</b>			<b>LH0119</b> Ht = 2" Width = 1 3/8"	<b>LH0120</b> Ht = 2" Width = 1 3/8"	<b>LH0123</b> Ht = 1 5/8" Width = 1 5/8"	<b>LH0124</b> Ht = 1 5/8" Width = 1 5/8"	<b>LH0151</b> Ht = 2 3/8" Width = 2 3/8"	<b>T6/T8/T12 Slimline</b>		
<b>LH0152</b> Ht = 2 3/8" Width = 2 3/8"	<b>LH0141</b> Ht = 2 1/8" Width = 1 1/8"	<b>LH0142</b> Ht = 1 1/16" Width = 1 1/8"	<b>LH0121</b> Ht = 1 1/8" Width = 1 1/8"	<b>LH0122</b> Ht = 3/4" Width = 3/4"	<b>LH0569</b> Ht = 7/8" Width = 3/4"	<b>LH0125</b> Ht = 2 5/16" Width = 1 3/4"	<b>LH0126</b> Ht = 2 5/16" Width = 1 3/4"	<b>LH0127</b> Discontinued	<b>LH0128</b> Discontinued	<b>LH0161</b> Ht = 1 7/8" Width = 1 1/8"

T6/T8/T12 Single Pin Lampholders (cont.)

										
<b>LH0162</b> Ht = 1 7/8" Width = 1 1/8"	<b>LH0295</b> Discontinued	<b>LH0296</b> Discontinued	<b>LH0143</b> Ht = 1 7/8" Width = 1 5/16" "T" slot	<b>LH0144</b> Ht = 1 7/8" Width = 1 5/16" "T" slot	<b>LH0157</b> Ht = 2 9/16" Width = 1 5/16"	<b>LH0158</b> Ht = 2 9/16" Width = 1 5/16"	<b>LH0159</b> Ht = 2" Width = 1 5/16"	<b>LH0160</b> Ht = 2" Width = 1 5/16"	<b>LH0372</b> Ht = 1 11/16" Width = 2 9/16"	<b>LH0373</b> Ht = 1 11/16" Width = 2 9/16"
										
			<b>LH0462</b> Ht = 3" Width = 9"	<b>LH0472</b> Ht = 3" Width = 9"	<b>LHB0063</b> Ht = 1/2" Width = 1 3/16"	<b>LHB0062</b> Ht = 1 15/16" Width = 1 3/16"	<b>LHB-841477</b> Ht = Width = Bracket for "True" cases			

T8/T10/T12 HO/VHO RDC Lampholders

										
<b>T8/T10/T12 RDC HO/VHO</b>			<b>LH0129</b> Ht = 1 15/16" Width = 1 3/8"	<b>LH0130</b> Ht = 1 15/16" Width = 1 3/8"	<b>LH0175</b> Ht = 1 15/16" Width = 1 3/8"	<b>LH0176</b> Ht = 1 15/16" Width = 1 3/8"	<b>LH0133</b> Ht = 1 5/8" Width = 1 5/8"	<b>T8/T10/T12 RDC HO/VHO</b>		
										
<b>LH0134</b> Ht = 1 5/8" Width = 1 5/8"	<b>LH0153</b> Ht = 2 3/8" Width = 2 3/8"	<b>LH0154</b> Ht = 2 3/8" Width = 2 3/8"	<b>LH0131</b> Ht = 1 1/8" Width = 1 1/8" Brackets LHB0062 LHB-841477	<b>LH0132</b> Ht = 1 1/8" Width = 1 1/8" Brackets LHB0063 LHB-841477	<b>LH0135</b> Ht = 1 13/16" Width = 1 7/16"	<b>LH0136</b> Ht = 1 13/16" Width = 1 7/16"	<b>LH0287</b> Ht = 1 15/16" Width = 1 7/16"	<b>LH0288</b> Ht = 1 15/16" Width = 1 7/16"	<b>LH0139</b> Ht = 2 5/16" Width = 1 7/16"	<b>LH0140</b> Ht = 2 5/16" Width = 1 7/16"
										
<b>LH0145</b> Ht = 2 5/16" Width = 1 7/16"	<b>LH0146</b> Ht = 2 5/16" Width = 1 7/16"	<b>LH0147</b> Ht = 2 7/16" Width = 1 5/16" "T" slot	<b>LH0148</b> Ht = 2 7/16" Width = 1 5/16" "T" slot	<b>LH0163</b> Ht = 2 9/16" Width = 1 5/16"	<b>LH0164</b> Ht = 2 9/16" Width = 1 5/16"	<b>LH0165</b> Ht = 2 1/16" Width = 1 5/16"	<b>LH0166</b> Ht = 2 1/16" Width = 1 5/16"	<b>LH0167</b> Ht = 2 9/16" Width = 1 5/16"	<b>LH0168</b> Ht = 2 9/16" Width = 1 5/16"	<b>LH0289</b> Ht = 2 9/16" Width = 1 5/16"
										
<b>LH0290</b> Ht = 2 9/16" Width = 1 5/16"	<b>LH0137</b> Ht = 2 3/4" Width = 1 7/16"	<b>LH0138</b> Ht = 2 3/4" Width = 1 7/16"	<b>LH0292</b> Ht = 2 3/4" Width = 1 3/4"	<b>LH0293</b> Ht = 2 3/4" Width = 1 3/4"	<b>LH0149</b> Ht = 1" Width = 1 1/16"	<b>LH0150</b> Ht = 1" Width = 1 1/16"	<b>LH0471</b> Ht = 3" Width = 9"	<b>LH0333</b> Ht = 1 11/16" Width = 2 9/16"	<b>LH0367</b> Ht = 2 1/4" Width = 3 1/8"	<b>LH0368</b> Ht = 2 1/4" Width = 3 1/8"
										
			<b>LHB0063</b> Ht = 1/2" Width = 1 3/16"	<b>LHB0062</b> Ht = 1 15/16" Width = 1 3/16"	<b>LHB-841477</b> Ht = Width = Bracket for "True" cases					

Miscellaneous Fluorescent Parts										
										
<b>LH0053</b> Ht = 3" Width = 1 1/4"	<b>LH0156</b> Ht = 3" Width = 1 1/4"	<b>LH0389</b> Ht = 3 1/8" Width = 1 1/4"	<b>LH0393</b> Ht = 1 1/2" Width = 1 3/16"	<b>LH0247</b> Ht = 1 1/2" Width = 2 3/16"	<b>LH0507</b> Ht = Width =	<b>LH0285</b> Ht = 1 1/8" Width = 1 1/4"	<b>LH0286</b> Ht = 1 1/8" Width = 1 1/4"	<b>LH0057</b> Ht = Width =	<b>LH0508</b> Ht = 1 1/16" Width = 113/16"	<b>LH0530</b> Ht = 7/8" Width = 1 1/4"
										
<b>LH0450</b> Ht = 7/8" Width = 1 3/8"	<b>LH0338</b> Ht = 1 1/2" Width = 1 3/8" T8 only Cap fits LH0101	<b>LH0358</b> Ht = 1 1/2" Width = 1 5/16" T8 only Cap fits LH0103, LH0104 and LH0364	<b>LH0339</b> Ht = 1 11/16" Width = 1" T12 only Cap fits LH0103 & LH0104	<b>LH0340</b> Ht = 1 9/16" Width = 15/16" T8 only Cap fits LH0105 & LH0106	<b>LH0341</b> Ht = 1 11/16" Width = 15/16" T12 only Cap fits LH0105 & LH0106	<b>LH0359</b> Ht = 1 11/16" Width = 111/16" Arctic lamps only Cap fits LH0105 & LH0106	<b>LH0371</b> Ht = 1 11/16" Width = 111/16" T12 only Cap fits LH0102	<b>LH0536</b> Ht = 1" Width = 1" T5 only Cap fits LH0524	<b>LH0317</b> Ht = 1 7/8" Width = 1 7/8" T8 only Cap fits LH0335	<b>LH0588</b> Ht = 1 9/16" Width = 2 1/16" T12 only Cap fits LH0335
										
<b>LH0497</b> Ht = 1 7/16" Width = 1 3/8"			<b>LH0241</b> Ht = 2" Width = 1 3/16" "U" lamp support		<b>LH0415</b> Ht = 1 5/16" Width = 1 1/8" Locking device for medium bipin lamps					

Click below to order

Interlight Specialty Bulbs  
 1-800-743-0005  
[www.interlight.biz](http://www.interlight.biz)

Click below to order

Interlight Specialty Bulbs  
1-800-743-0005  
[www.interlight.biz](http://www.interlight.biz)

# CFL Lampholders



5, 7, 9 and 11w Twin Tube



Twin Tube



Quad Tube



10, 13, 18, 26, 32, 42, 57 and  
75w Triple tube



10, 13, 18, 26 and 32 Quad  
Tube



Triple Tube



18, 24 and 36w Flat Quad



18, 24, 36, 40, 50 and 55w  
Long Twin Tube



13w Twin Tube



# 2-pin CFL Lampholders

Click below to order

Interlight Specialty Bulbs  
 1-800-743-0005  
[www.interlight.biz](http://www.interlight.biz)



Twin Tube



Quad Tube



Triple Tube

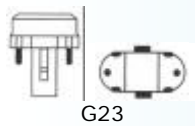

G23

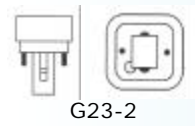

G23-2



GX23



GX23-2

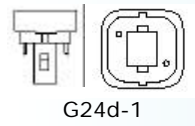

G24d-1

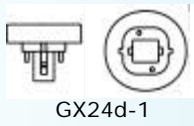

GX24d-1

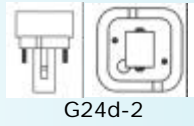

G24d-2

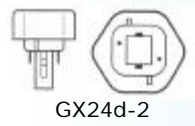

GX24d-2

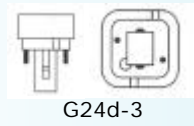

G24d-3

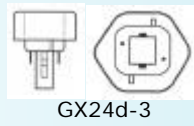

GX24d-3

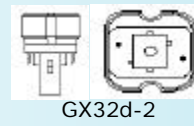

GX32d-2

Section	Page(s)
2-pin CFL Lampholders	13 - 16
G23 / G23-2	13
GX23 / GX23-2	13 - 14
G24d-1 / GX24d-1	14
G24d-2 / GX24d-2	15
G24d-3 / GX24d-3	15 - 16
GX32d-3	16



5/7/9/11w 2pin G23 base Twin Tube CFL

		<b>LH0178</b> Ht = 1 5/16" Width = 1 1/8"	<b>LH0181</b> Ht = 1 1/4" Width = 1 5/16"	<b>LH0184</b> Ht = 1 1/4" Width = 1 5/16"	<b>LH0177</b> Ht = 1 1/4" Width = 2"	<b>LH0193</b> Ht = 1 1/16" Width =	<b>LH0187</b> Ht = 1 3/8" Width = 1 3/8"	<b>LH0188</b> Ht = 1 3/16" Width = 1 1/4"		
<b>LH0179</b> Ht = 1 1/8" Width = 1 1/4"	<b>LH0183</b> Ht = 1 1/8" Width = 1 3/8"	<b>LH0192</b> Ht = Width =	<b>LH0374</b> Ht = Width =	<b>LH0191</b> Ht = 1 1/4" Width = 1 7/16"	<b>LH0195</b> Ht = Width =	<b>LH0185</b> Ht = Width = 1 3/8"	<b>LH0186</b> Ht = 1 3/8" Width = 1 3/8"	<b>LH0194</b> Ht = Width =	<b>LH0182</b> Ht = 1 1/2" Width = 1 5/16"	<b>LH0180</b> Ht = Width = 1 3/8"
<b>LH0189</b> Ht = Width =	<b>LH0190</b> Ht = Width =	<b>LH0320</b> Ht = Width =	<b>LH0274</b> Ht = 1 7/16" Width = 5/8" Mounts in rectangular hole	<b>LH0273</b> Ht = 1 7/16" Width = 5/8" Mounts in round hole	<b>LH0321</b> Ht = 1 1/16" Width = 1 1/4" Screw mount	<b>LH0322</b> Ht = 1 5/16" Width = 1 1/4" Mounts in round hole	<b>LH0329</b> Ht = Adjustable Width = 1 1/4" Mounts in round hole	<b>LH0331</b> Ht = Adjustable Width = 1 3/16" Mounts in round hole	<b>LH0319</b> Ht = Width = 1 7/16"	

5/7/9/11w 2pin G23-2 base Quad tube CFL

		<b>LH0181</b> Ht = 1 1/4" Width = 1 5/16"	<b>LH0178</b> Ht = 1 5/16" Width = 1 1/8"	<b>LH0184</b> Ht = 1 1/4" Width = 1 5/16"	<b>LH0177</b> Ht = 1 1/4" Width = 2"	<b>LH0179</b> Ht = 1 1/8" Width = 1 1/4"	<b>LH0183</b> Ht = 1 1/8" Width = 1 3/8"	<b>LH0180</b> Ht = 1 5/16" Width = 1 3/8"	<b>LH0182</b> Ht = 1 1/2" Width = 1 5/16"		

13w 2pin GX23 base Twin Tube CFL

		<b>LH0227</b> Ht = 1 5/16" Width = 1 1/8"	<b>LH0230</b> Ht = 1 5/16" Width = 1 1/8"	<b>LH0332</b> Ht = 1 1/8" Width = 1 7/16"	<b>LH0234</b> Ht = 1 1/4" Width = 1 5/16"	<b>LH0233</b> Ht = 1 1/16" Width =	<b>LH0226</b> Ht = 1 1/8" Width = 2"	<b>LH0240</b> Ht = 1 3/16" Width = 1 1/4"		
<b>LH0228</b> Ht = 1 1/8" Width = 1 1/4"	<b>LH0232</b> Ht = Width = 1 7/16"	<b>LH0235</b> Ht = 1 7/16" Width = 1 3/8"	<b>LH0231</b> Ht = 1 3/8" Width = 1"	<b>LH0239</b> Ht = 1 3/8" Width = 1 3/8"	<b>LH0229</b> Ht = 1 1/8" Width = 1 3/8"	<b>LH0237</b> Ht = Width = 1 3/8"	<b>LH0238</b> Ht = 1 3/8" Width = 1 3/8"	<b>LH0236</b> Ht = Width = 1 3/8"	<b>LH0586</b> Ht = 1 1/8" Width = 1 3/8"	<b>LH0274</b> Ht = 1 7/16" Width = 5/8" Mounts in rectangular hole
		<b>LH0273</b> Ht = 1 7/16" Width = 5/8" Mounts in round hole	<b>LH0321</b> Ht = 1 1/16" Width = 1 1/4" Screw mount	<b>LH0322</b> Ht = 1 5/16" Width = 1 1/4" Mounts in round hole	<b>LH0329</b> Ht = Adjustable Width = 1 1/4" Mounts in round hole	<b>LH0331</b> Ht = Adjustable Width = 1 3/16" Mounts in round hole				

13w 2pin GX23-2 base Quad CFL

	<b>LH0230</b> Ht = 1 1/4" Width = 1 5/16"	<b>LH0227</b> Ht = 1 5/16" Width = 1 1/8"	<b>LH0234</b> Ht = 1 1/4" Width = 1 5/16"	<b>LH0233</b> Ht = 1 1/16" Width =	<b>LH0226</b> Ht = 1 1/8" Width = 2"	<b>LH0228</b> Ht = 1 1/8" Width = 1 1/4"	<b>LH0232</b> Ht = Width = 1 7/16"			

Click below to order

Interlight Specialty Bulbs  
 1-800-743-0005  
[www.interlight.biz](http://www.interlight.biz)

<b>LH0231</b> Ht = 1 3/8" Width = 1"	<b>LH0229</b> Ht = 1 1/8" Width = 1 3/8"	<b>LH0235</b> Ht = 1 7/16" Width = 1 3/8"	<b>LH0586</b> Ht = 1 1/8" Width = 1 3/8"

8/10/13w 2pin G24d-1 base Quad CFL

	<b>LH0196</b> Ht = 1 1/4" Width = 1 3/8"	<b>LH0197</b> Ht = 1 1/8" Width = 1 1/4"	<b>LH0198</b> Ht = Width = 1 1/2"	<b>LH0199</b> Ht = Width = 1 5/16"	<b>LH0200</b> Ht = 1 1/4" Width = 1 1/2"	<b>LH0201</b> Ht = 1 9/16" Width = 1 5/16"	<b>LH0202</b> Ht = 1 3/16" Width = 1 3/16"			

<b>LH0203</b> Ht = 1 1/4" Width = 1 9/16"	<b>LH0300</b> Discontinued	<b>LH0301</b> Ht = Width = 1 9/16"	<b>LH0281</b> Ht = 1 1/4" Width = 1 7/16"

8/10/13w 2-pin GX24d-1 Triple Tube CFL

	<b>LH0196</b> Ht = 1 1/4" Width = 1 3/8"	<b>LH0197</b> Ht = 1 5/16" Width = 1 3/8"	<b>LH0198</b> Ht = Width = 1 1/2"	<b>LH0199</b> Ht = Width = 1 5/16"	<b>LH0201</b> Ht = 1 9/16" Width = 1 5/16"	<b>LH0202</b> Ht = 1 3/16" Width = 1 7/16"	<b>LH0203</b> Ht = 1 1/4" Width = 1 5/16"			

<b>LH0300</b> Discontinued	<b>LH0301</b> Ht = Width = 1 9/16"

18w 2-pin G24d-2 Quad Tube CFL

	<p><b>LH0204</b> Ht = 1 5/16" Width = 1 3/8"</p>	<p><b>LH0205</b> Ht = 1 5/16" Width = 1 3/8"</p>	<p><b>LH0206</b> Ht = Width = 1 1/2"</p>	<p><b>LH0207</b> Ht = 1 11/16" Width = 1 15/16"</p>	<p><b>LH0208</b> Ht = 1 3/4" Width = 1 1/2"</p>	<p><b>LH0209</b> Ht = 1 9/16" Width = 1 3/8"</p>	<p><b>LH0210</b> Ht = 1 3/16" Width = 1 7/16"</p>			

Click below to order

Interlight Specialty Bulbs  
1-800-743-0005  
[www.interlight.biz](http://www.interlight.biz)

<p><b>LH0211</b> Ht = 1 5/16" Width = 1 9/16"</p>	<p><b>LH0302</b> Ht = Width = 1 9/16"</p>	<p><b>LH0281</b> Ht = 1 1/4" Width = 1 7/16"</p>

18w 2-pin GX24d-2 Triple Tube CFL

	<p><b>LH0204</b> Ht = 1 5/16" Width = 1 3/8"</p>	<p><b>LH0205</b> Ht = 1 5/16" Width = 1 3/8"</p>	<p><b>LH0206</b> Ht = Width = 1 1/2"</p>	<p><b>LH0207</b> Ht = 1 11/16" Width = 1 5/16"</p>	<p><b>LH0209</b> Ht = 1 9/16" Width = 1 3/8"</p>	<p><b>LH0210</b> Ht = 1 3/16" Width = 1 7/16"</p>	<p><b>LH0211</b> Ht = 1 5/16" Width = 1 9/16"</p>			

<p><b>LH0302</b> Ht = Width = 1 9/16"</p>

26w 2-pin G24d-3 Quad Tube CFL

	<p><b>LH0172</b> Ht = 1 5/16" Width = 1 3/8"</p>	<p><b>LH0212</b> Ht = 1 5/16" Width = 1 3/8"</p>	<p><b>LH0213</b> Ht = 1 3/8" Width = 1 1/2"</p>	<p><b>LH0214</b> Ht = 1 11/16" Width = 1 5/16"</p>	<p><b>LH0215</b> Ht = 1 3/4" Width = 1 1/2"</p>	<p><b>LH0216</b> Ht = 1 9/16" Width = 1 5/16"</p>	<p><b>LH0217</b> Ht = 1 7/16" Width = 1 7/16"</p>			

<p><b>LH0218</b> Ht = 1 1/4" Width = 1 5/16"</p>	<p><b>LH0303</b> Ht = Width = 1 3/8"</p>	<p><b>LH0281</b> Ht = 1 1/4" Width = 1 7/16"</p>

**26w 2-pin GX24d-3 Triple Tube CFL**

										
		<b>LH0172</b> Ht = 1 5/16" Width = 1 3/8"	<b>LH0212</b> Ht = 1 5/16" Width = 1 3/8"	<b>LH0213</b> Ht = 1 3/8" Width = 1 1/2"	<b>LH0214</b> Ht = 1 11/16" Width = 1 5/16"	<b>LH0216</b> Ht = 1 9/16" Width = 1 5/16"	<b>LH0217</b> Ht = 1 7/16" Width = 1 7/16"	<b>LH0218</b> Ht = 1 1/4" Width = 1 5/16"		



**LH0303**  
 Ht =  
 Width = 1 3/8"

**28w 2-pin GX32d-3 Quad Tube CFL**

					
		<b>LH0499</b> Ht = 1 11/16" Width = 1 11/16"			

Click below to order

Interlight Specialty Bulbs  
 1-800-743-0005  
[www.interlight.biz](http://www.interlight.biz)

# 4-pin CFL Lampholders

Click below to order

Interlight Specialty Bulbs  
 1-800-743-0005  
[www.interlight.biz](http://www.interlight.biz)



10, 13, 18, 26 and 32 Quad Tube



10, 13, 18, 26, 32, 42, 57 and 75w Triple tube



13w Twin Tube



5, 7, 9 and 11w Twin Tube



18, 24 and 36w Flat Quad



18, 24, 36, 40, 50 and 55w Long Twin Tube

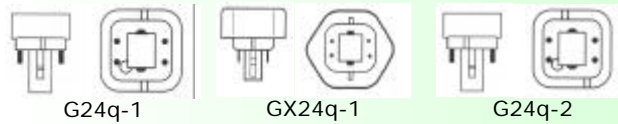

G24q-1

GX24q-1

G24q-2

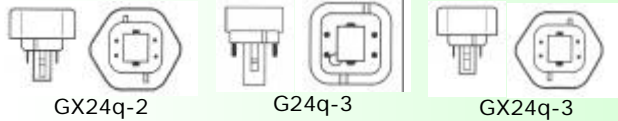

GX24q-2

G24q-3

GX24q-3

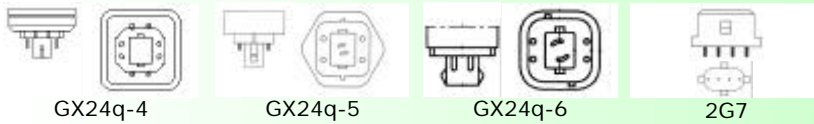

GX24q-4

GX24q-5

GX24q-6

2G7

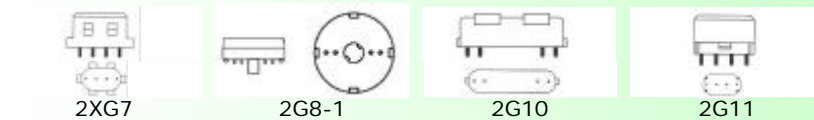

2XG7

2G8-1

2G10

2G11

## Section

Page(s)

### 4-pin CFL Lampholders

18 - 22

G24q-1 / GX24q-1

18

G24q-2 / GX24q-2

18 - 19

G24q-3 / GX24q-3

19

GX24q-4 / GX24q-5 / GX24q-6

20

2G7 / 2GX7

21

2G8-1 / 2G10

21

2G11

22

10/13w 4-pin G24q-1 base Quad Tube

	<b>LH0174</b> Ht = 1 5/16" Width = 1 3/8"	<b>LH0346</b> Ht = 1 3/16" Width = 1 1/4" For: 10,13,18,26,32 & 42w	<b>LH0219</b> Ht = 1 5/16" Width = 1 3/8"	<b>LH0221</b> Ht = 1 7/8" Width = 1 5/16" 57w when used with LH0568	<b>LH0222</b> Ht = 1 7/8" Width = 1 1/2" 57w when used with LH0568	<b>LH0223</b> Ht = 1 3/4" Width = 1 1/2" 57w when used with LH0568			
		<b>LH0224</b> Ht = 1 7/16" Width = 1 3/8" 57w when used with LH0568	<b>LH0282</b> Ht = 1 9/16" Width = 1 9/16" 57w when used with LH0568	<b>LH0225</b> Ht = 1 7/16" Width = 1 7/16" 57w when used with LH0568	<b>LH0220</b> Ht = 1 9/16" Width = 1 9/16" 57w when used with LH0568	<b>LH0564</b> Ht = 1 7/16" Width = 1 7/16" 57w when used with LH0566	<b>LH0281</b> Ht = 1 1/4" Width = 1 7/16"		

10/13w 4-pin GX24q-1 base Triple Tube

	<b>LH0174</b> Ht = 1 5/16" Width = 1 3/8"	<b>LH0346</b> Ht = 1 3/16" Width = 1 1/4" For: 10,13,18,26,32 & 42w	<b>LH0219</b> Ht = 1 5/16" Width = 1 3/8"	<b>LH0222</b> Ht = 1 1/2" Width = 1 1/2" 57w when used with LH0568	<b>LH0221</b> Ht = 1 7/8" Width = 1 5/16" 57w when used with LH0568	<b>LH0224</b> Ht = 1 7/16" Width = 1 3/8" 57w when used with LH0568			
		<b>LH0225</b> Ht = 1 7/16" Width = 1 7/16" 57w when used with LH0568	<b>LH0220</b> Ht = 1 9/16" Width = 1 9/16" 57w when used with LH0568	<b>LH0564</b> Ht = 1 7/16" Width = 1 7/16" 75w when used with LH0566	<b>LH0282</b> Ht = 1 9/16" Width = 1 9/16" 57w when used with LH0568				

18w 4-pin G24q-2 base Quad Tube

	<b>LH0242</b> Ht = 1 5/16" Width = 1 3/8"	<b>LH0346</b> Ht = 1 3/16" Width = 1 1/4" For: 10,13,18,26,32 & 42w	<b>LH0504</b> Ht = 1 1/2" Width = 1 5/16"	<b>LH0243</b> Ht = 1 1/2" Width = 1 5/16"	<b>LH0244</b> Ht = 1 7/8" Width = 1 1/2"	<b>LH0245</b> Ht = 1 11/16" Width = 1 5/16"			
		<b>LH0386</b> Ht = 1 7/16" Width = 1 3/8"	<b>LH0248</b> Ht = 1 7/16" Width = 1 7/16"	<b>LH0249</b> Ht = 1 9/16" Width = 1 9/16"	<b>LH0563</b> Ht = 1 7/16" Width = 1 7/16" 75w when used with LH0566	<b>LH0246</b> Ht = 1 3/4" Width = 1 1/2"	<b>LH0281</b> Ht = 1 1/4" Width = 1 7/16"		

18w 4-pin GX24q-2 base Triple Tube

	<p><b>LH0242</b> Ht = 1 5/16" Width = 1 3/8"</p>	<p><b>LH0346</b> Ht = 1 3/16" Width = 1 1/4"</p>	<p><b>LH0243</b> Ht = Width = 1 5/16"</p>	<p><b>LH0244</b> Ht = 1 7/8" Width = 1 1/2"</p>	<p><b>LH0245</b> Ht = 1 11/16" Width = 1 5/16"</p>	<p><b>LH0504</b> Ht = 1 1/2" Width = 1 5/16"</p>			

Click below to order

Interlight Specialty Bulbs  
1-800-743-0005  
[www.interlight.biz](http://www.interlight.biz)

<p><b>LH0386</b> Ht = 1 9/16" Width = 1 3/8"</p>	<p><b>LH0248</b> Ht = 1 7/16" Width = 1 7/16"</p>	<p><b>LH0249</b> Ht = 1 9/16" Width = 1 9/16"</p>	<p><b>LH0563</b> Ht = 1 7/16" Width = 1 7/16" 75w when used with LH0566</p>

26/32w 4-pin G24q-3 base Quad Tube

	<p><b>LH0250</b> Ht = 1 5/16" Width = 1 3/8"</p>	<p><b>LH0346</b> Ht = 1 3/16" Width = 1 1/4" For: 10,13,18,26,32 &amp; 42w</p>	<p><b>LH0529</b> Ht = 1 5/16" Width = 1 3/8" Also does 42w</p>	<p><b>LH0252</b> Ht = 1 7/8" Width = 1 1/2"</p>	<p><b>LH0253</b> Ht = 1 3/4" Width = 1 5/16"</p>	<p><b>LH0254</b> Ht = Width = 1 1/2"</p>			

<p><b>LH0255</b> Ht = 1 9/16" Width = 1 5/16"</p>	<p><b>LH0256</b> Ht = 1 7/16" Width = 1 7/16"</p>	<p><b>LH0560</b> Ht = 1 7/16" Width = 1 7/16" Also does 42w</p>	<p><b>LH0561</b> Ht = Width = Also does 42w</p>	<p><b>LH0257</b> Ht = 1 9/16" Width = 1 9/16"</p>	<p><b>LH0299</b> Ht = 1 9/16" Width = 1 9/16" Also does 42w</p>	<p><b>LH0565</b> Ht = 1 7/16" Width = 1 7/16" Also does 42w</p>	<p><b>LH0251</b> Ht = 1 5/16" Width = 1 5/16" Also does 42w</p>	<p><b>LH0281</b> Ht = 1 1/4" Width = 1 7/16"</p>

26/32w 4-pin GX24q-3 base Triple Tube

	<p><b>LH0250</b> Ht = 1 5/16" Width = 1 3/8"</p>	<p><b>LH0346</b> Ht = 1 3/16" Width = 1 1/4" For: 10,13,18,26,32 &amp; 42w</p>	<p><b>LH0529</b> Ht = 1 5/16" Width = 1 3/8" Also does 42w</p>	<p><b>LH0255</b> Ht = 1 9/16" Width = 1 5/16"</p>	<p><b>LH0252</b> Ht = 1 7/8" Width = 1 5/16"</p>	<p><b>LH0253</b> Ht = 1 3/4" Width = 1 5/16"</p>			

<p><b>LH0256</b> Ht = 1 7/16" Width = 1 7/16"</p>	<p><b>LH0257</b> Ht = 1 7/16" Width = 1 9/16"</p>	<p><b>LH0560</b> Ht = 1 7/16" Width = 1 7/16" Also does 42w</p>	<p><b>LH0561</b> Ht = Width = Also does 42w</p>	<p><b>LH0299</b> Ht = 1 9/16" Width = 1 9/16" Also does 42w</p>	<p><b>LH0565</b> Ht = 1 7/16" Width = 1 7/16" Also does 42w</p>

42w 4-pin GX24q-4 base Triple Tube CFL

	<b>LH0258</b> Ht = 1 5/16" Width = 1 3/8"	<b>LH0346</b> Ht = 1 3/16" Width = 1 1/4" For: 10,13,18,26,32 & 42w		<b>LH0529</b> Ht = 1 5/16" Width = 1 3/8" Also for 26 & 32w	<b>LH0259</b> Ht = 1 5/16" Width = 1 5/16"	<b>LH0260</b> Ht = Width = 1 5/16"	<b>LH0261</b> Ht = 1 9/16" Width = 1 5/16"		
	<b>LH0262</b> Ht = 1 7/16" Width = 1 7/16"	<b>LH0256</b> Ht = 1 7/16" Width = 1 7/16" Also for 26 & 32w	<b>LH0560</b> Ht = 1 7/16" Width = 1 7/16" Also for 26 & 32w	<b>LH0263</b> Ht = 1 9/16" Width = 1 9/16"	<b>LH0299</b> Ht = 1 9/16" Width = 1 9/16" Also for 26 & 32w	<b>LH0565</b> Ht = 1 7/16" Width = 1 7/16" Also for 26 & 32w	<b>LHB0258</b> Ht = Width =		

57w 4-pin GX24q-5 base Triple Tube CFL

	<b>LH0516</b> Ht = 1 3/8" Width = 1 3/8"	<b>LH0566</b> Ht = 1/2" Width = 11/16" Insert for LH0564 for 57w lamps	<b>LH0564</b> Ht = 1 7/16" Width = 1 7/16" Use insert LH0566 for 57w Without for 10,13w lamps	<b>LH0568</b> Ht = Width = Insert for LH0221,222,223,224,225,282 & 220 for 57w lamps	<b>LH0221</b> Ht = 1 7/8" Width = 1 5/16" Use insert LH0568 for 57w Without for 10,13w lamps	<b>LH0222</b> Ht = Width = 1 1/2" Use insert LH0568 for 57w Without for 10,13w lamps	<b>LH0223</b> Ht = 1 3/4" Width = 1 1/2" Use insert LH0568 for 57w Without for 10,13w lamps			
		<b>LH0224</b> Ht = 1 7/16" Width = 1 3/8" Use insert LH0568 for 57w Without for 10,13w lamps	<b>LH0225</b> Ht = 1 7/16" Width = 1 7/16" Use insert LH0568 for 57w Without for 10,13w lamps	<b>LH0282</b> Ht = Width = 1 9/16" Use insert LH0568 for 57w Without for 10,13w lamps	<b>LH0220</b> Ht = 1 9/16" Width = 1 9/16" Use insert LH0568 for 57w Without for 10,13w lamps					

75w 4-pin GX24q-6 base Triple Tube CFL

	<b>LH0517</b> Ht = 1 3/8" Width = 1 3/8"	<b>LH0563</b> Ht = 1 7/16" Width = 1 7/16" Use insert LH0566 for 75w Without for 18w lamps	<b>LH0566</b> Ht = 1/2" Width = 11/16" Insert for LH0563 for 75w lamps	<b>LH0568</b> Ht = Width = Insert for LH0244, 245,248, 249 & 246 for 75w lamps	<b>LH0244</b> Ht = 1 7/8" Width = 1 1/2" Use insert LH0568 for 75w Without for 18w lamps	<b>LH0245</b> Ht = 1 11/16" Width = 1 5/16" Use insert LH0568 for 75w Without for 18w lamps	<b>LH0248</b> Ht = 1 7/16" Width = 1 7/16" Use insert LH0568 for 75w Without for 18w lamps			
		<b>LH0249</b> Ht = 1 9/16" Width = 1 9/16" Use insert LH0568 for 75w Without for 18w lamps	<b>LH0246</b> Ht = 1 3/4" Width = 1 1/2" Use insert LH0568 for 75w Without for 18w lamps							

5/7/9/11w 4-pin 2G7 base

		<b>LH0264</b> Ht = Width = 1 5/8"	<b>LH0304</b> Ht = 1 5/16" Width = 1 9/16"	<b>LH0305</b> Ht = 1 5/16" Width = 1 9/16"	<b>LH0306</b> Ht = 1 1/4" Width = 1 9/16"	<b>LH0307</b> Ht = 1 3/8" Width = 1 9/16"	<b>LH0322</b> Ht = 1 5/16" Width = 1 1/4" Mounts in round hole	<b>LH0321</b> Ht = 1 1/16" Width = 1 1/4" Screw mount		

<b>LH0329</b> Ht = Adjustable Width = 1 3/16" Mounts in round hole	<b>LH0331</b> Ht = Adjustable Width = 1 3/16" Mounts in round hole

13w 4-pin 2GX7 base

		<b>LH0312</b> Ht = 1 1/8" Width = 1 5/8"	<b>LH0308</b> Ht = Width = 1 9/16"	<b>LH0309</b> Ht = 1 5/16" Width = 1 9/16"	<b>LH0310</b> Ht = 1 1/4" Width = 1 9/16"	<b>LH0311</b> Ht = 1 5/16" Width = 1 9/16"	<b>LH0329</b> Ht = Adjustable Width = 1 3/16" Mounts in round hole	<b>LH0331</b> Ht = Adjustable Width = 1 3/16" Mounts in round hole		

<b>LH0322</b> Ht = 1 5/16" Width = 1 1/4" Mounts in round hole	<b>LH0321</b> Ht = 1 1/16" Width = 1 1/4" Screw mount

60/85/120w 2G8-1 base Triple Tube

		<b>LH0509</b> Ht = 2 3/8" Width = 2 3/8"	

4-pin 2G10 base Flat Quad

		<b>LH0265</b> Ht = 1 7/16" Width = 3 1/16"	<b>LH0276</b> Ht = 1 5/8" Width = 9/16" Fits in rectangular hole	<b>LH0275</b> Ht = 1 5/8" Width = 9/16" Fits in round hole	<b>LH0278</b> Ht = 1 11/16" Width = 5/8" Fits in rectangular hole	<b>LH0277</b> Ht = 1 11/16" Width = 5/8" Fits in round hole		

4-pin 2G11 base

		<b>LH0173</b> Ht = 1 1/4" Width = 2 7/8"	<b>LH0266</b> Ht = 1 1/8" Width = 2 3/8"	<b>LH0267</b> Ht = 1 1/8" Width = 2 3/16"	<b>LH0002</b> Ht = 1 15/16" Width = 2 3/16"	<b>LH0269</b> Ht = 1 15/16" Width = 1 7/8" Swivel bracket LHB0269	<b>LH0270</b> Ht = 1 15/16" Width = 1 7/8"	<b>LH0544</b> Ht = 1 1/2" Width = 2"										
<b>LH0315</b> Ht = 1 7/16" Width = 111/16"	<b>LH0327</b> Ht = 1 9/16" Width = 1 7/8"	<b>LH0481</b> Ht = 1 9/16" Width = 1 7/8"	<b>LH0271</b> Ht = 1 15/16" Width = 1 5/16"	<b>LH0505</b> Ht = 2 1/16" Width = 1 3/8"	<b>LH0328</b> Ht = 1 9/16" Width = 1 7/8"	<b>LH0326</b> Ht = Width =	<b>LH0314</b> Ht = 1 5/16" Width = 2 1/2"	<b>LH0325</b> Ht = 1 1/2" Width = 2 3/16"	<b>LH0272</b> Ht = 1 5/8" Width = 1 7/8"	<b>LH0313</b> Ht = 1 11/16" Width = 2"								
<b>LH0318</b> Ht = 1 5/16" Width = 2 3/8"	<b>LH0544</b> Ht = 1 9/16" Width = 2"	<b>LH0366</b> Ht = 1 1/2" Width = 1 11/16"	<b>LH0268</b> Ht = Width =	<b>LH0324</b> Ht = 1 1/4" Width = 1 5/8" Mounts in round hole	<b>LH0330</b> Ht = Adjustable Width = 1 5/8" Mounts in round hole	<b>LH0334</b> Ht = Adjustable Width = 1 5/8" Mounts in round hole	<b>LH0316</b> Ht = Adjustable Width = 1 5/8" Mounts in round hole	<b>LH0356</b> Ht = 1 1/16" Width = 111/16" Mounts in rectan- gular hole	<b>LH0323</b> Ht = 1 1/4" Width = 1 5/8" Mounts with screw through bottom	<b>LHB0323</b> Ht = 5/8" Width = 1 5/16" Bracket mounts to LH0323								
<b>LH0502</b> Ht = 1 1/16" Width = 1 1/4"	<b>LH0535</b> Ht = 1 1/4" Width = 1 3/8"	<b>LH0280</b> Ht = 1 3/16" Width = 2"	<b>LH0275</b> Ht = 1 5/8" Width = 9/16" Mounts in round hole	<b>LH0276</b> Ht = 1 5/8" Width = 9/16" Mounts in rectan- gular hole	<b>LH0277</b> Ht = 1 11/16" Width = 5/8" Mounts in round hole	<b>LH0278</b> Ht = 1 11/16" Width = 5/8" Mounts in rectan- gular hole	<b>LH0155</b> Ht = 1" Width = 7/8" Mounts in round hole	<b>LH0279</b> Ht = 1" Width = 13/16" Mounts in round hole	<b>LHB0269</b> Ht = 1" Width = 113/16" Swivel bracket for LH0269									

GRY10q base 2-d lamps

		<b>LH0555</b> Ht = 1 3/4" Width = 1 3/16" For 10,16,21,28 & 38W lamps	<b>LH0554</b> Ht = Width = 1 3/16" For 55w lamps		

Click below to order

Interlight Specialty Bulbs  
1-800-743-0005  
[www.interlight.biz](http://www.interlight.biz)

# Incandescent Lampholders



E39  
Mogul



E26  
Medium



G12.7  
Medium Side Prong



GX16d  
Mogul End Prong



E17 Intermediate

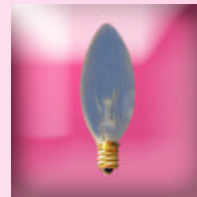

E12 Candelabra



T3 1/4 T5  
Wedge



E39  
Mogul

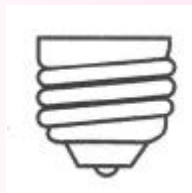

E26/E27  
Medium



BA15s  
SC Bayonet

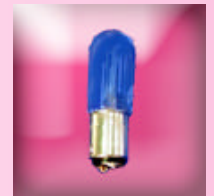

BA15d  
DC Bayonet

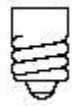

E17  
Intermediate



E12  
Candelabra

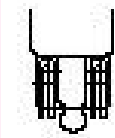

T3 1/4 / T5  
Wedge

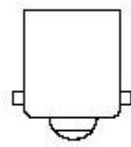

BA15s  
SC Bayonet



BA15d  
DC Bayonet

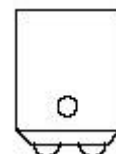

G12.7  
Medium Side Prong

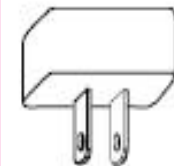

GX16d  
Mogul End Prong

Section

Page(s)

Incandescent Lampholders

24 - 25

Medium base Incandescent

										
E26/E27 Medium (deonotes 26mm or 27mm in diameter)	<b>LH0001</b> Ht = 1 9/16" Width = 11/16"	<b>LH0375</b> Ht = 1 5/8" Width = 1 5/8"	<b>LH0416</b> Ht = 1 5/8" Width = 1 7/16"	<b>LH0493</b> Ht = 1 5/16" Width = 2 3/16"	<b>LH0395</b> Ht = 1 11/16" Width = 11/16"	<b>LH0473</b> Ht = 1 11/16" Width = 11/16"	<b>LH0096</b> Ht = 1 11/16" Width = 1 1/2" Captive screws	<b>LH0088</b> Ht = 1 11/16" Width = 1 1/2" Captive screws	<b>LH0408</b> Ht = 1 1/2" Width = 1 3/8"	E26/E27 Medium (deonotes 26mm or 27mm in diameter)
										
<b>LH0543</b> Ht = 1 1/2" Width = 1 3/8"	<b>LH0410</b> Ht = 1 7/16" Width = 1 3/8"	<b>LH0421</b> Ht = 2 5/16" Width = 1 3/4"	<b>LH0417</b> Ht = 2" Width = 1 1/2"	<b>LH0407</b> Ht = 1 11/16" Width = 1 1/2" 1/8-27 die cast cap	<b>LH0478</b> Ht = 1 1/2" Width = 1 3/8" 1/8 IPS hickey	<b>LH0528</b> Ht = 1 13/16" Width = 1 3/8" 1/8 IPS hickey	<b>LH0381</b> Ht = 1 1/2" Width = 1 3/4"	<b>LH0399</b> Ht = 1 3/8" Width = 1 3/4"	<b>LH0405</b> Ht = 1 1/2" Width = 2 5/16"	<b>LH0400</b> Ht = 1 1/16" Width = 115/16"
										
<b>LH0382</b> Ht = 1 1/2" Width = 2 5/8"	<b>LH0422</b> Ht = 1 5/8" Width = 2 9/16"	<b>LH0409</b> Ht = 1 7/16" Width = 1 5/8" Tapped bushings	<b>LH0418</b> Ht = 3 1/8" Width = 1 1/2"	<b>LH0419</b> Ht = 3 1/8" Width = 1 1/2"	<b>LH0420</b> Ht = 1 1/2" Width = 2 1/8"	<b>LH0423</b> Ht = 1 7/16" Width = 1 1/2"	<b>LH0406</b> Ht = 1 11/16" Width = 1 9/16" 1/8 IPS cap Retaining ring LHR0406	<b>LH0503</b> Ht = 3" Width = 3"	<b>LH0091</b> Ht = 2 3/16" Width = 1 3/8" Extends 1 3/16"	<b>LH0402</b> Ht = 1 9/16" Width = 1 1/8" Extends 1 1/4"
										
			<b>LH0432</b> Ht = 2 3/8" Width = 1 1/2" Extends 1 3/8"	<b>LH0291</b> Ht = 2 3/16" Width = 1 5/8" Extends 1 1/4"	<b>LHR0406</b> Ht = 3/8" Width = 2 3/8" Ring for lampholder LH0406					

Candelabra base



Intermediate Base

									
Candelabra E12 (denotes 12mm in diameter)	<b>LH0391</b> Ht = 1 7/16" Width = 3/4"	<b>LH0550</b> Ht = 1 1/4" Width = 1 1/16" Part of three part system	<b>LH0573</b> Ht = 11/16" Width = 1 3/16" Part of three part system	<b>LH0575</b> Ht = 1 1/16" Width = 1 1/8" Part of three part system	Candelabra E12 (denotes 12mm in diameter)	Intermediate E17 (denotes 17mm in diameter)	<b>LH0425</b> Ht = 1 7/16" Width = 1"	<b>LH0426</b> Ht = 2 3/8" Width = 1 5/8"	Intermediate E17 (denotes 17mm in diameter)

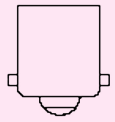

Mogul base

		
Mogul E39 (denotes 39mm in diameter)	<b>LH0427</b> Ht = 3 3/16" Width = 2 1/8" 1/4 IPS cap	Mogul E39 (denotes 39mm in diameter)

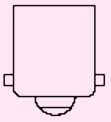
Single Contact Bayonet

			
Single contact B15S (denotes 15mm in diameter)	<b>LH0428</b> Ht = 15/16" Width = 1 1/2"	<b>LH0429</b> Ht = 1 1/16" Width = 1 5/16"	Single contact B15S (denotes 15mm in diameter)

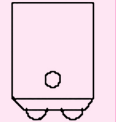
Double Contact Bayonet

			
Double contact BA15d (denotes 15mm in diameter)	<b>LH0378</b> Ht = 3/4" Width = 1 1/16"	<b>LH0379</b> Ht = 1" Width = 1 1/16"	Double contact BA15d (denotes 15mm in diameter)

Wedge base

					
Wedge base	<b>LH0430</b> Ht = 5/16" Width = 1/2"	<b>LH0431</b> Ht = 3/8" Width = 9/16"	<b>LH0512</b> Ht = 5/16" Width = 9/16"	<b>LH0534</b> Ht = 1/4" Width = 1/2"	Wedge base

Side/End Prong

			
Medium Side Prong	<b>LH0433</b> Ht = 5/8" Width = 1 3/8" Par38 / Par46 side prong	<b>LH0369</b> Ht = 1 1/4" Width = 2 3/16" Mogul End Prong	Mogul End Prong GX16d

Click below to order

Interlight Specialty Bulbs  
 1-800-743-0005  
[www.interlight.biz](http://www.interlight.biz)

# H.I.D. Lampholders

Click below to order

Interlight Specialty Bulbs

1-800-743-0005

[www.interlight.biz](http://www.interlight.biz)

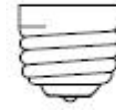

Medium  
E26

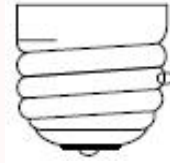

POMB Mogul  
(position oriented)  
E39

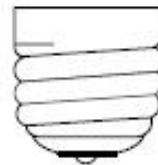

Mogul  
E39

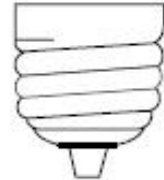

Extended Eyelet  
Mogul  
EX39



Fc2

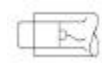

R7s

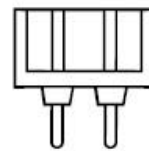

G12

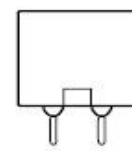

PG12

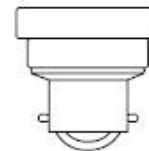

Bay22d  
(low pressure sodium)

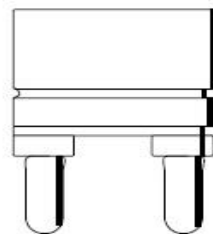

Mogul BiPin  
G38

# H.I.D. Lampholders



BT56  
E39 Mogul Base



ED37  
POMB E39  
Mogul Base



BT37  
EX39 Mogul  
(For open rated fixtures)



T21  
Bay22d base



G38 base

Click below to order

Interlight Specialty Bulbs  
1-800-743-0005  
[www.interlight.biz](http://www.interlight.biz)



T6  
G12 base

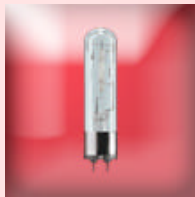

T10  
PG12 base

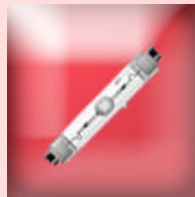

Fc2 base

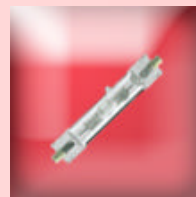

T6  
RX7s base

Section

Page(s)

H.I.D. Lampholders

28 - 29







Mogul Base H.I.D.

																		
Mogul E39 (39mm)	Extended Eyelet Mogul (for Open Fixture Rated lamps) E39 EX39 (39mm)	POMB Mogul (for Position Oriented lamps) E39 (39mm)	<b>LH0363</b> Ht = 2 5/8" Width = 2 1/8" 6kv Captive screws No notches	<b>LH0424</b> Ht = 2 5/8" Width = 2 1/8" 6kv Captive screws Notches	<b>LH0476</b> Ht = 2 5/8" Width = 2 1/8" 4kv Captive screws Notches	<b>LH0479</b> Ht = 2 5/8" Width = 2 3/16" 4kv Captive screws Notches	<b>LH0548</b> Ht = 2 5/8" Width = 2 1/8" 6kv Captive nuts Notches	POMB Mogul (for Position Oriented lamps) E39 (39mm)	Extended Eyelet Mogul (for Open Fixture Rated lamps) EX39	Mogul E39 (39mm)								
       																		
<table border="1"> <tr> <td><b>LH0580</b> Ht = 2 5/8" Width = 2 1/8" 6kv Captive nuts No Notches</td> <td><b>LH0470</b> Ht = 2 5/8" Width = 2 3/16" 4kv Captive Nuts Notches</td> <td><b>LH0515</b> Ht = 3" Width = 2 3/4" 5kv Notches</td> <td><b>LH0437</b> Ht = 2 5/8" Width = 2 3/16" Yellow 4kv POM Captive screws Notches</td> <td><b>LH0360</b> Ht = 2 5/8" Width = 2 1/8" Pink open fixture Captive screws No notches</td> <td><b>LH0526</b> Ht = 2 3/8" Width = 2 5/16"</td> <td><b>LH0403</b> Ht = 4" Width = 2 1/4" 4kv</td> <td><b>LH0377</b> Ht = 3" Width = 1 13/16" Medium to Mogul enlarger</td> </tr> </table>											<b>LH0580</b> Ht = 2 5/8" Width = 2 1/8" 6kv Captive nuts No Notches	<b>LH0470</b> Ht = 2 5/8" Width = 2 3/16" 4kv Captive Nuts Notches	<b>LH0515</b> Ht = 3" Width = 2 3/4" 5kv Notches	<b>LH0437</b> Ht = 2 5/8" Width = 2 3/16" Yellow 4kv POM Captive screws Notches	<b>LH0360</b> Ht = 2 5/8" Width = 2 1/8" Pink open fixture Captive screws No notches	<b>LH0526</b> Ht = 2 3/8" Width = 2 5/16"	<b>LH0403</b> Ht = 4" Width = 2 1/4" 4kv	<b>LH0377</b> Ht = 3" Width = 1 13/16" Medium to Mogul enlarger
<b>LH0580</b> Ht = 2 5/8" Width = 2 1/8" 6kv Captive nuts No Notches	<b>LH0470</b> Ht = 2 5/8" Width = 2 3/16" 4kv Captive Nuts Notches	<b>LH0515</b> Ht = 3" Width = 2 3/4" 5kv Notches	<b>LH0437</b> Ht = 2 5/8" Width = 2 3/16" Yellow 4kv POM Captive screws Notches	<b>LH0360</b> Ht = 2 5/8" Width = 2 1/8" Pink open fixture Captive screws No notches	<b>LH0526</b> Ht = 2 3/8" Width = 2 5/16"	<b>LH0403</b> Ht = 4" Width = 2 1/4" 4kv	<b>LH0377</b> Ht = 3" Width = 1 13/16" Medium to Mogul enlarger											

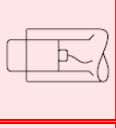

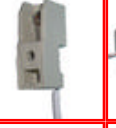
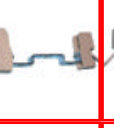
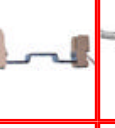
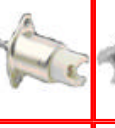
Medium Base H.I.D.

																	
Medium base E27 (27mm)	<b>LH0436</b> Ht = 1 11/16" Width = 1 11/16" 4kv	<b>LH0542</b> Ht = 1 5/8" Width = 2 3/16" 4kv	<b>LH0533</b> Ht = 1 5/8" Width = 4kv	<b>LH0414</b> Ht = 1 11/16" Width = 1 1/2" 4kv Captive screws Notches	<b>LH0487</b> Ht = 1 11/16" Width = 1 1/2" 4kv Captive Nuts Notches	<b>LH0522</b> Ht = 1 11/16" Width = 1 1/2" 4kv Captive screws No Notches	<b>LH0397</b> Ht = 1 7/16" Width = 1 3/8" 4kv Captive screws Notches	<b>LH0581</b> Ht = 1 5/16" Width = 1 1/2" 5kv Captive Nuts Notches	<b>LH0518</b> Ht = 1 15/16" Width = 1 1/16" 5kv Captive Nuts Notches	Medium base E27 (27mm)							
      																	
<table border="1"> <tr> <td><b>LH0551</b> Ht = 1 13/16" Width = 1 3/4" 4kv Notches</td> <td><b>LH0520</b> Ht = 2 1/4" Width = 1 11/16" 4kv open fixture rated</td> <td><b>LH0577</b> Ht = 1 13/16" Width = 1 9/16" 4kv LH0578 cap LH0576 ring</td> <td><b>LH0576</b> Ht = 5/16" Width = 1 5/16" Screw ring for LH0577</td> <td><b>LH0578</b> Ht = 1 1/2" Width = 1 1/2" Cap for LH0577</td> <td><b>LH0438</b> Ht = 2 1/4" Width = 1 5/8" 4kv Extends lamp 1 1/4"</td> <td><b>LH0377</b> Ht = 3" Width = 1 13/16" Medium to Mogul enlarger</td> </tr> </table>											<b>LH0551</b> Ht = 1 13/16" Width = 1 3/4" 4kv Notches	<b>LH0520</b> Ht = 2 1/4" Width = 1 11/16" 4kv open fixture rated	<b>LH0577</b> Ht = 1 13/16" Width = 1 9/16" 4kv LH0578 cap LH0576 ring	<b>LH0576</b> Ht = 5/16" Width = 1 5/16" Screw ring for LH0577	<b>LH0578</b> Ht = 1 1/2" Width = 1 1/2" Cap for LH0577	<b>LH0438</b> Ht = 2 1/4" Width = 1 5/8" 4kv Extends lamp 1 1/4"	<b>LH0377</b> Ht = 3" Width = 1 13/16" Medium to Mogul enlarger
<b>LH0551</b> Ht = 1 13/16" Width = 1 3/4" 4kv Notches	<b>LH0520</b> Ht = 2 1/4" Width = 1 11/16" 4kv open fixture rated	<b>LH0577</b> Ht = 1 13/16" Width = 1 9/16" 4kv LH0578 cap LH0576 ring	<b>LH0576</b> Ht = 5/16" Width = 1 5/16" Screw ring for LH0577	<b>LH0578</b> Ht = 1 1/2" Width = 1 1/2" Cap for LH0577	<b>LH0438</b> Ht = 2 1/4" Width = 1 5/8" 4kv Extends lamp 1 1/4"	<b>LH0377</b> Ht = 3" Width = 1 13/16" Medium to Mogul enlarger											

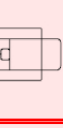

Double Ended H.I.D.

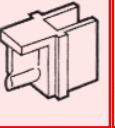
										
Recessed Single Contact R7S	<b>LH0466</b> Ht = 9/16" Width = 9/16" 5kv	<b>LH0467</b> Ht = 9/16" Width = 9/16" 5kv	<b>LH0169</b> Ht = 1 3/4" Width = 9/16" 5kv	<b>LH0170</b> Ht = 1 3/4" Width = 5 9/16" 5kv	<b>LH0171</b> Ht = 1 3/4" Width = 6 1/4" 5kv	<b>LH0468</b> Ht = 9/16" Width = 9/16"	<b>LH0469</b> Ht = 9/16" Width = 9/16"	<b>LH0579</b> Ht = 1 3/16" Width = 1 3/4" 35kv	<b>LH0584</b> Ht = 7/16" Width = 1 7/16" 5kv	Recessed Single Contact R7S

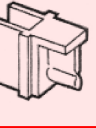

Double Ended Fc2 H.I.D.

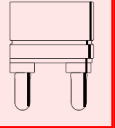
		
Fc2	<b>LH0549</b> Ht = 1 3/4" Width = 1 7/8"	Fc2

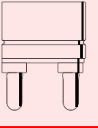
Mogul BiPost H.I.D.

		
Mogul BiPost G38	<b>LH0388</b> Ht = 2 13/16" Width = 4" 50kv	Mogul BiPost G38

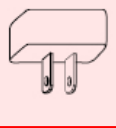
Mogul End Prong

		
GX16d Mogul End Prong	<b>LH0463</b> Ht = 1 1/4" Width = 2 7/16" 5kv	GX16d Mogul End Prong

G8.5/G12/PG12 GiPin H.I.D.

									
	<b>LH0558</b> Ht = 1 3/16" Width = 1 1/8" 5kv G8.5	<b>LH0434</b> Ht = 1 3/16" Width = 1 5/8" 5kv G12	<b>LH0559</b> Ht = 7/8" Width = 1 7/16" 5kv G12	<b>LH0384</b> Ht = 2 3/8" Width = 1 5/8" 5kv PG12 WhiteSon	<b>LH0342</b> Ht = 1 3/4" Width = 1 3/8" PG12-1 base	<b>LH0506</b> Ht = 1 1/8" Width = 1 1/2" 5kv PG12-1 base			

Low Pressure Sodium

H.I.D. Extenders & Reducers

			
Double Contact Bayonet base (for LPS lamps) Bay22d	<b>LH0298</b> Ht = 1 1/2" Width = 1 7/16"	<b>LH0435</b> Ht = 1 5/8" Width = 2 1/4"	Double Contact Bayonet base (for LPS lamps) Bay22d

		
<b>LH0438</b> Ht = 2 3/16" Width = 1 5/8" 4kv Extends lamp 1 1/8"	<b>LH0403</b> Ht = 4" Width = 2 1/4" 4kv Extends lamp 2 3/8"	<b>LH0377</b> Ht = 3" Width = 1 13/16" Medium to Mogul enlarger

Click below to order

Interlight Specialty Bulbs  
 1-800-743-0005  
[www.interlight.biz](http://www.interlight.biz)

# Halogen Lampholders

Click below to order

Interlight Specialty Bulbs  
 1-800-743-0005  
[www.interlight.biz](http://www.interlight.biz)



T5  
Wedge  
base



G4  
(4mm ctr to  
ctr pins)



G5.3  
(5.3mm ctr to  
ctr pins)

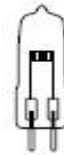

G6.35  
(6.35mm ctr to ctr  
pins)



GY6.35  
(6.35mm ctr to ctr  
on pins)



G9  
(9mm ctr to ctr on  
pins)

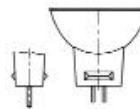

GU4  
(4mm ctr to ctr on  
pins with groove or  
rib on base)

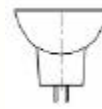

GZ4  
(4mm ctr to ctr on  
pins, no groove or  
rib on base)

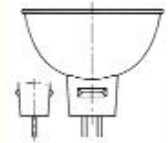

GU5.3  
(5.3mm ctr to ctr  
on pins with groove  
or rib on base)

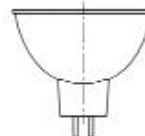

GX5.3  
(5.3mm ctr to ctr  
on pins, no groove  
or rib on base)

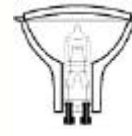

GU7  
Turn and Lock  
(7mm ctr to ctr on  
pins)



GU10  
(10mm ctr to ctr on  
pins)



BA15d  
(15mm base diam-  
eter)

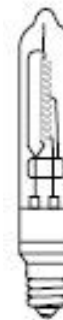

E11  
(11mm base diam-  
eter)



R7s  
(7mm)  
Recessed single  
contact

# Halogen Lampholders

Click below to order

Interlight Specialty Bulbs  
 1-800-743-0005  
[www.interlight.biz](http://www.interlight.biz)



GU4 base  
(MR11 lamp)



GZ4 base  
(MR11 lamp)



GU5.3 base  
(MR16 lamp)



GX5.3 base  
(MR16 lamp)



GU7  
(MR16 lamp)



GU10 base  
(MR16 lamp)



GZ10 base  
(MR16 lamp)



Wedge base  
(T3 1/4)

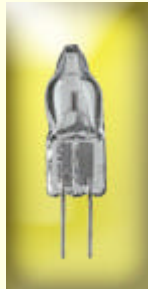

G4 base  
(T3 lamp)



G6.35 base  
(T3 lamp)



GY6.35 base  
(T3 lamp)



G9 base  
(T4 lamp)



B15d  
(T4 lamp)



R7s  
(T3 lamp)



E11  
(T4 lamp)

Section

Page(s)

Halogen Lampholders

32 - 33

G4/GU4/GZ4 Halogen

G4 (4mm ctr to ctr on pins) BiPin capsule	GU4 (4mm ctr to ctr on pins) MR11 (with groove or rib on base)	GZ4 (4mm ctr to ctr on pins) MR11 (no groove or rib on base)	LH0439 Ht = 13/16" Width = 13/16" Fits G4,G6.35, GY6.35, GX5.3 & GZ4	LH0345 Ht = 11/16" Width = 11/16" Fits G4,G6.35, GY6.35, GX5.3 & GZ4	LH0540 Ht = 11/16" Width = 11/16" 18" long leads Fits G4,G6.35, GY6.35, GX5.3 & GZ4	LH0523 Ht = 11/16" Width = 11/16" Fits G4,G6.35, GY6.35, GX5.3 & GZ4	LH0380 Ht = 11/16" Width = 11/16" Fits G4,G6.35, GY6.35, GX5.3 & GZ4	GZ4 (4mm ctr to ctr on pins) MR11 (no groove or rib on base)	GU4 (4mm ctr to ctr on pins) MR11 (with groove or rib on base)	G4 (4mm ctr to ctr on pins) BiPin capsule

Click below to order

Interlight Specialty Bulbs  
1-800-743-0005  
[www.interlight.biz](http://www.interlight.biz)

LH0446 Ht = 5/8" Width = 1 1/16" Fits G4,G6.35, GY6.35, GX5.3 & GZ4	LH0401 Ht = 9/16" Width = 5/8" Fits G4	LH0449 Ht = 3/8" Width = 9/16" Fits G4	LHB0345 Ht = 11/16" Width = 3/4" Fits LH0345 & LH0540

G5.3 / GU5.3 / GX5.3 BiPin / MR13 & MR16 Halogen

G5.3 (5.3 mm ctr to ctr on pins)	GU5.3 (5.3mm ctr to ctr on pins) MR16 (with groove or rib on base)	GX5.3 (5.3mm ctr to ctr on pins) MR16 (no groove or rib on base)	LH0439 Ht = 13/16" Width = 13/16" Fits G4,G6.35, GY6.35, GX5.3 & GZ4	LH0345 Ht = 11/16" Width = 11/16" Fits G4,G6.35, GY6.35, GX5.3 & GZ4	LH0540 Ht = 11/16" Width = 11/16" 18" long leads Fits G4,G6.35, GY6.35, GX5.3 & GZ4	LH0523 Ht = 11/16" Width = 11/16" Fits G4,G6.35, GY6.35, GX5.3 & GZ4	LH0552 Ht = 3/8" Width = 3/4" Fits GU5.3	GX5.3 (5.3mm ctr to ctr on pins) MR16 (no groove or rib on base)	GU5.3 (5.3mm ctr to ctr on pins) MR16 (with groove or rib on base)	G5.3 (5.3 mm ctr to ctr on pins)

LH0553 Ht = 3/4" Width = 11/16" Fits GU5.3	LH0095 Ht = 1 5/8" Width = 1 5/8" Fits GX5.3	LH0380 Ht = 11/16" Width = 11/16" Fits G4,G6.35, GY6.35, GX5.3 & GZ4	LH0392 Ht = 1 1/16" Width = 3/4" Fits GX5.3	LH0390 Ht = 1 1/16" Width = 3/4" Fits GX5.3	LH0440 Ht = 1 1/8" Width = 113/16" Fits GX5.3	LH0446 Ht = 5/8" Width = 1 1/16" Fits G4,G6.35, GY6.35, GX5.3 & GZ4	LH0445 Ht = 11/16" Width = 1 1/8" Fits GX5.3	LH0531 Ht = 3/4" Width = 1/2" Fits GX5.3	LH0354 Ht = 2 1/8" Width = 115/16" Fits GY5.3









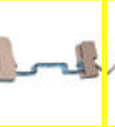
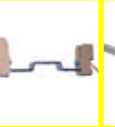

G6.35 / GY6.35 BiPin Halogen

G6.35 (6.35 mm ctr to ctr on pins)	GY6.35 (6.35mm ctr to ctr on pins) BiPin Capsule	LH0439 Ht = 13/16" Width = 13/16" Fits G4,G6.35, GY6.35, GX5.3 & GZ4	LH0345 Ht = 11/16" Width = 11/16" Fits G4,G6.35, GY6.35, GX5.3 & GZ4	LH0540 Ht = 11/16" Width = 11/16" 18" long leads Fits G4,G6.35, GY6.35, GX5.3 & GZ4	LH0523 Ht = 11/16" Width = 11/16" Fits G4,G6.35, GY6.35, GX5.3 & GZ4	LH0380 Ht = 11/16" Width = 11/16" Fits G4,G6.35, GY6.35, GX5.3 & GZ4	LH0446 Ht = 5/8" Width = 1 1/16" Fits G4,G6.35, GY6.35, GX5.3 & GZ4	LH0444 Ht = Width = Fits G4 & G6.35	GY6.35 (6.35mm ctr to ctr on pins) BiPin Capsule	G6.35 (6.35 mm ctr to ctr on pins)

GU7 Turn & Lock / GZ10 Twist & Lock MR16 Halogen

GU7 Turn and Lock (7mm ctr to ctr on pins)	GU10 (10mm ctr to ctr on pins)	GZ10 (10mm ctr to ctr on pins)	LH0494 Ht = 3/4" Width = 7/8" Fits GU7	LH0582 Ht = 1 1/8" Width = 1 1/8" Fits GU10	LH0398 Ht = 1 1/8" Width = 1 1/8" Fits GZ10	GZ10 (10mm ctr to ctr on pins)	GU10 (10mm ctr to ctr on pins)	GU7 Turn and Lock (7mm ctr to ctr on pins)

Double Ended Halogen

										
R7s (7mm) Recessed single contact	<b>LH0412</b> Ht = 1 3/4" Width = 9/16" Brackets LHB0169-104mm, LHB0169-136mm & LHB0169-136mms	<b>LH0480</b> Ht = 1 3/4" Width = 4" 5kv 78mm aprox lamp length	<b>LH0170</b> Ht = 1 3/4" Width = 5 9/16" 5kv 118mm aprox lamp length	<b>LH0171</b> Ht = 1 3/4" Width = 6 1/4" 5kv 136mm aprox lamp length	<b>LH0464</b> Ht = 1" Width = 1 9/16" Stationary	<b>LH0376</b> Ht = 1" Width = 1 9/16" Compressible	<b>LH0465</b> Ht = Width = 9/16" Stationary	<b>LH0411</b> Ht = 1 7/16" Width = 13/8" Compressible	<b>LHB0169-104mm</b> Ht = 11/16" Width = 215/16" Bracket for LHB0169	R7s (7mm) Recessed single contact
										
					<b>LHB0169-136mm</b> Ht = 5/8" Width = 4 3/16" Bracket for LHB0169	<b>LHB0169-136mms</b> Ht = 9/16" Width = 4 3/16" Bracket for LHB0169				

E11 Single Ended Mini-Can

				
E11 (11mm base diameter)	<b>LH0442</b> Ht = 13/16" Width = 1 9/16"	<b>LH0443</b> Ht = 1 1/8" Width = 1 5/8"	<b>LH0441</b> Ht = 1 9/16" Width = 1 3/16"	E11 (11mm base diameter)



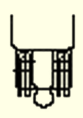

Wedge Base Halogen

			
Wedge base	<b>LH0431</b> Ht = 3/8" Width = 9/16"	<b>LH0430</b> Ht = 3/16" Width = 1/2"	Wedge base

G9 base Halogen

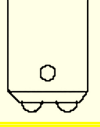
				
G9 (9mm ctr to ctr on pins)	<b>LH0448</b> Ht = 7/8" Width = 11/16"	<b>LH0447</b> Ht = 5/8" Width = 1 3/16"	<b>LH0557</b> Ht = 7/8" Width = 1 5/16"	G9 (9mm ctr to ctr on pins)

Double Contact Halogen

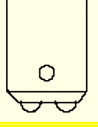
				
BA15d	<b>LH0378</b> Ht = 1" Width = 11/16"	<b>LH0379</b> Ht = 1" Width = 11/16"	<b>LH0572</b> Ht = 1 1/2" Width = 1 1/4"	BA15d

Miscellaneous Components

										
<b>LH0456</b> Ht = 1 9/16" Width = 1 3/16" Candelabra to Medium enlarger	<b>LH0377</b> Ht = 3" Width = 113/16" Medium to Mogul enlarger	<b>LH0404</b> Ht = 1 15/16" Width = 1 5/8" Mogul to Medium reducer 4kv	<b>LH0451</b> Ht = 1 1/4" Width = 1 1/8" Medium to Candelabra reducer	<b>LH0452</b> Ht = 1 15/16" Width = 1 1/16" Medium to Intermediate reducer	<b>LH0453</b> Ht = 13/16" Width = 9/16" German-Italian to candelabra reducer	<b>LH0454</b> Ht = 7/8" Width = 11/16" Intermediate to Candelabra reducer	<b>LH0455</b> Ht = Width = Medium to Double Contact Bayonet converter	<b>LH0457</b> Ht = 1 11/16" Width = 1 1/4" Medium to GU10- GZ10 adapter	<b>LH0458</b> Ht = 1 3/16" Width = 1 1/4" Medium to Nema 1-15P receptacle	<b>LH0459</b> Ht = 2" Width = 1 5/16" Nema 1-15 Non-polarized plug to medium

			
<b>LH0460</b> Ht = Width =	<b>LH0461</b> Ht = Width =	<b>SRK- F11WL6</b>	<b>SW0001</b>

Click below to order

Interlight Specialty Bulbs  
 1-800-743-0005  
[www.interlight.biz](http://www.interlight.biz)

# Case Cords

Click below to order

Interlight Specialty Bulbs  
1-800-743-0005  
[www.interlight.biz](http://www.interlight.biz)

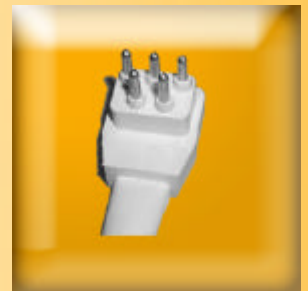





Section	Page(s)
Case Cords	
2-pin	36
3-pin	36 - 37
4-pin	37
5-pin	37 - 38
7-pin	38
Combination cords	38



2-Pin

			
<p><b>HMD-P21075-36</b>                  36" leads                  Mates to                  HMD-R210-36                  &amp;                  HMD-R21-36W</p>	<p><b>HMD-R210-36</b>                  36" leads                  Mates to                  HMD-P21075-36                  &amp;                  HMD-P21075-W</p>	<p><b>HMD-P21075-W</b>                  36" leads                  Mates to                  HMD-R-210-36                  &amp;                  HMD-R21-36W</p>	<p><b>HMD-R21-36W</b>                  36" leads                  Mates to                  HMD-P21075-36                  &amp;                  HMD-P21075-W</p>

3-Pin

				
<p><b>HMD-P32-18</b> (18" leads)  <b>HMD-P32-36</b> (36" leads)                  Mates to                  HMD-R31-36 / HMD-R31A-36 /                  HMD-R310A-36 / HMD-R310B-                  36 / HMD-R35-18</p>	<p><b>HMD-R31-36</b>                  36" leads                  Mates to                  HMD-P32-18                  &amp;                  HMD-P32-36</p>	<p><b>HMD-R31A-36</b>                  36" leads                  Mates to                  HMD-P32-18                  &amp;                  HMD-P32-36</p>	<p><b>HMD-R310A-36</b>                  36" leads                  Mates to                  HMD-P32-18                  &amp;                  HMD-P32-36</p>	<p><b>HMD-R310B-36</b>                  36" leads                  Mates to                  HMD-P32-18                  &amp;                  HMD-P32-36</p>
				
<p><b>HMD-R35-18</b>                  18" leads                  Mates to                  HMD-P32-18                  &amp;                  HMD-P32-36</p>	<p><b>HMD-P323-36</b>                  36" leads                  Mates to                  HMD-R323A-36</p>	<p><b>HMD-R323A-36</b>                  Mates to                  HMD-P323-36</p>	<p><b>HMD-P326-18</b>                  18" leads                  Mates to                  HMD-R326</p>	<p><b>HMD-R326</b>                  48" leads                  Mates to                  HMD-P326</p>
				
<p><b>HMD-P34A-36W</b>                  36" leads                  Mates to                  HMD-R34075-36W</p>	<p><b>HMD-R34075-36W</b>                  36" leads                  Mates to                  HMD-P34A-36W</p>	<p><b>HMD-P33-36B</b>                  36" leads                  Mates to                  HMD-R33-36B</p>	<p><b>HMD-R33-36B</b>                  36" leads                  Mates to                  HMD-P33-36B</p>	<p><b>HMD-P33A</b>                  9" leads                  Mates to                  HMD-R33A</p>
				
<p><b>HMD-R33A</b>                  Mates to                  HMD-P33A</p>	<p><b>HMD125-01-1081</b>                  36" leads                  Mates to                  HMD125-01-1083</p>	<p><b>HMD125-01-1083</b>                  144" leads                  Mates to                  HMD125-01-1081</p>		

3-Pin (continued)

Click below to order

Interlight Specialty Bulbs  
1-800-743-0005  
[www.interlight.biz](http://www.interlight.biz)

		
<p><b>HMD-P333-48W</b> 48" leads Mates to HMD-R333-72W</p>	<p><b>HMD-P333-48B</b> 48" leads Mates to HMD-R333-72W</p>	<p><b>HMD-R333-72W</b> 72" leads Mates to HMD-P333-48W &amp; HMD-P333-48B</p>

4-Pin



	
<p><b>HMD-P411-36</b> 36" leads Mates to HMD-R411-36</p>	<p><b>HMD-R411-36</b> 36" leads Mates to HMD-P411-36</p>

5-Pin





				
<p><b>HMD-P52-36</b> Mates to HMD-R52-36</p>	<p><b>HMD-R52-36</b> 36" leads Mates to HMD-P52-36</p>	<p><b>HMD-P581-36</b> 36" leads Mates to HMD-R59-36</p>	<p><b>HMD-P582-36</b> 36" leads Mates to HMD-R59-36</p>	<p><b>HMD-R59-36</b> 36" leads Mates to HMD-P581-36 &amp; HMD-P582-36</p>
				
<p><b>HMD-0111897</b> 35" leads Mates to HMD-0210591</p>	<p><b>HMD-0210591</b> Mates to HMD-0111897</p>	<p><b>HMD-0425438</b> 96" leads Mates to HMD-0430113</p>	<p><b>HMD-0430113</b> 10" leads Mates to HMD-0425438</p>	<p><b>10988</b> 72" leads Mates to 10989</p>
				
<p><b>10989</b> 33" leads Mates to 10988</p>	<p><b>HMD-P533-48B</b> 48" Leads Mates to HMD-R533-72B HMD-R533-72W</p>	<p><b>HMD-P533-48W</b> 48" Leads Mates to HMD-R533-72B HMD-R533-72W</p>	<p><b>HMD-R533-72B</b> 72" leads Mates to HMD-P533-48B HMD-P533-48W</p>	<p><b>HMD-R533-72W</b> 72" leads Mates to HMD-P533-48B HMD-P533-48W</p>

Interlight Specialty Bulbs  
 1-800-743-0005  
[www.interlight.biz](http://www.interlight.biz)

5-Pin (continued)

			
<p><b>H0001-M</b>                  35" leads                  Mates to                  H0001-F</p>		<p><b>H0001-F</b>                  144" leads                  Mates to                  H0001-M</p>	

7-Pin

			
<p><b>EP.125-01-3126</b>                  35" leads                  Mates to                  EP.125-01-3127</p>		<p><b>EP.125-01-3127</b>                  144" leads                  Mates to                  EP.125-01-3126</p>	

Combination Cords

				
<p><b>HMD-P33AR323A-4</b>                  Consists of:                  1-HMD-P33A                  &amp;                  1-HMD-R323A</p>	<p><b>HMD-P32R33A-4</b>                  Consists of:                  1-HMD-P32                  &amp;                  1-HMD-R33A</p>	<p><b>HMD-P323 / R33A-4</b>                  Consists of:                  1-HMD-P323                  &amp;                  1-HMD-R33A</p>	<p><b>HMD-P33R35-4</b>                  Consists of:                  1-HMD-P33A                  &amp;                  1-HMD-R35</p>	<p><b>HMD-P3-2R3-3A</b>                  Consists of:                  1-HMD-P33A                  &amp;                  2-HMD-R33A</p>
				
<p><b>HMD-P31-2R35-W</b>                  Consists of:                  2-HMD-R35                  &amp;                  1-HMD-P31</p>				

# Undercabinet Fixtures

Click below to order

Interlight Specialty Bulbs  
1-800-743-0005  
[www.interlight.biz](http://www.interlight.biz)



Please use the above images to help you identify which under-cabinet fixture you need.

Section	Page(s)
Undercabinet fixtures	
Antares fixtures	42 - 43
Hera fixtures	44 - 45
Sunpark fixtures	46

Interlight Specialty Bulbs  
1-800-743-0005  
[www.interlight.biz](http://www.interlight.biz)

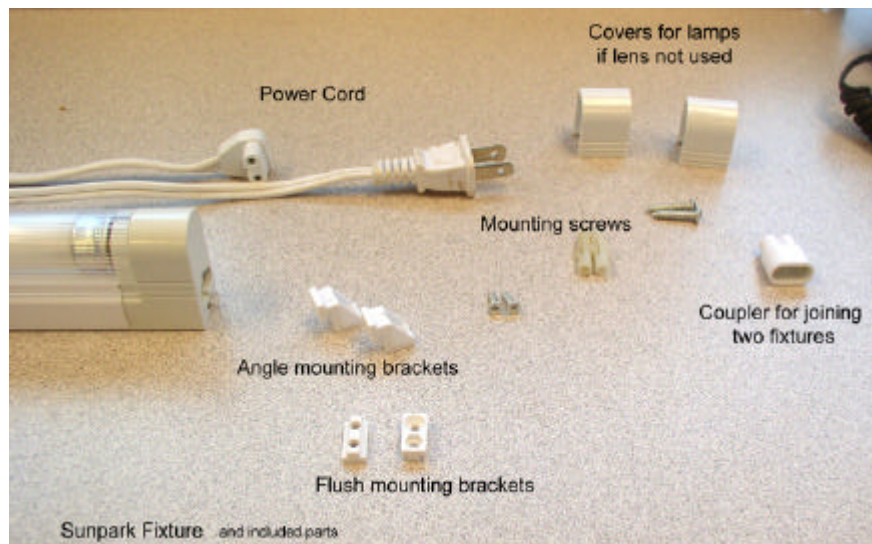
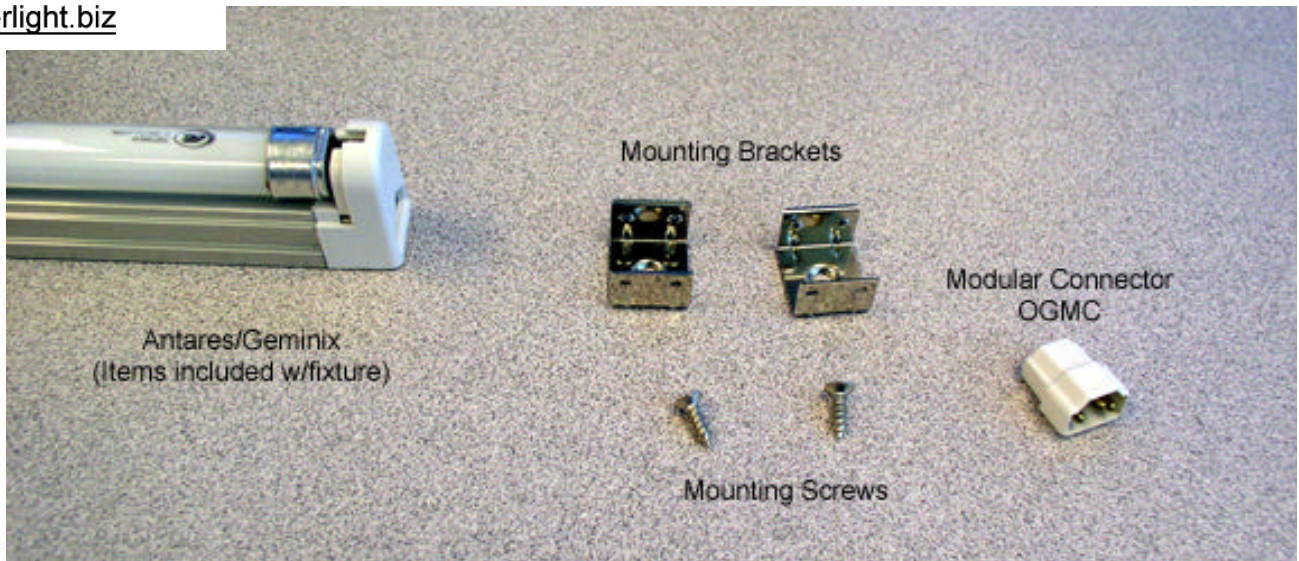

<u>Manuf</u>	<u>Model</u>	<u>Part #</u>	<u>Lamp</u>	<u>Length</u>	<u>Width</u>	<u>Height</u>
Antares	Geminix	GT509	F6T5	9 3/8"	3/4"	1 3/8"
Antares	Geminix	GT512	F8T5	12 3/8"	3/4"	1 3/8"
Sunpark	T5 Ultra-Slim	YGLLD-8	F8T5	13 7/16"	7/8"	1 5/8"
Sunpark	T5 Ultra-Slim	YGLLD-13	F13T5	22 1/2"	7/8"	1 5/8"
Antares	Geminix	GT522	F14T5	22 1/2"	3/4"	1 3/8"
Hera	Slimlite XL	ES22.BC	F14T5	23 1/8"	29/32"	1 5/16"
Sunpark	T5 Ultra-Slim	YGLLD-14	F14T5	23 3/4"	7/8"	1 5/8"
Antares	Geminix	GT534	F21T5	34 1/2"	3/4"	1 3/8"
Hera	Slimlite XL	ES34.BC	F21T5	34 7/8"	29/32"	1 5/16"
Sunpark	T5 Ultra-Slim	YGLLD-21	F21T5	35 9/16"	7/8"	1 5/8"
Antares	Geminix	GT546	F28T5	46 1/4"	3/4"	1 3/8"
Hera	Slimlite XL	ES46.BC	F28T5	46 3/4"	29/32"	1 5/16"
Sunpark	T5 Ultra-Slim	YGLLD-28	F28T5	47 3/8"	7/8"	1 5/8"
Antares	Geminix	GT559	F35T5	58"	3/4"	1 3/8"
Hera	Slimlite XL	ES59.BC	F35T5	58 7/16"	29/32"	1 5/16"



Interlight Specialty Bulbs  
 1-800-743-0005  
[www.interlight.biz](http://www.interlight.biz)

**Antares  
 Geminix T5 Fixtures**

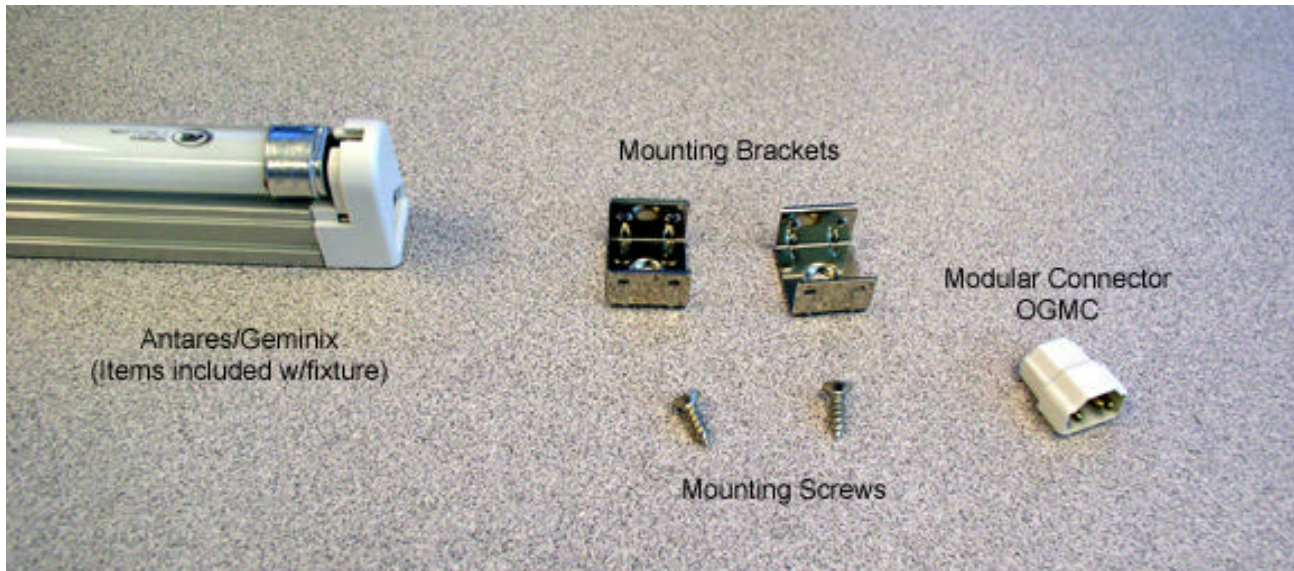

<u>Manuf</u>	<u>Model</u>	<u>Part #</u>	<u>Lamp</u>	<u>Length</u>	<u>Width</u>	<u>Height</u>
Antares	Geminix	GT509	F6T5	9 3/8"	3/4"	1 3/8"
Antares	Geminix	GT512	F8T5	12 3/8"	3/4"	1 3/8"
Antares	Geminix	GT522	F14T5	22 1/2"	3/4"	1 3/8"
Antares	Geminix	GT534	F21T5	34 1/2"	3/4"	1 3/8"
Antares	Geminix	GT546	F28T5	46 1/4"	3/4"	1 3/8"
Antares	Geminix	GT559	F35T5	58"	3/4"	1 3/8"

**Antares  
 Odyssey T4 Fixtures**

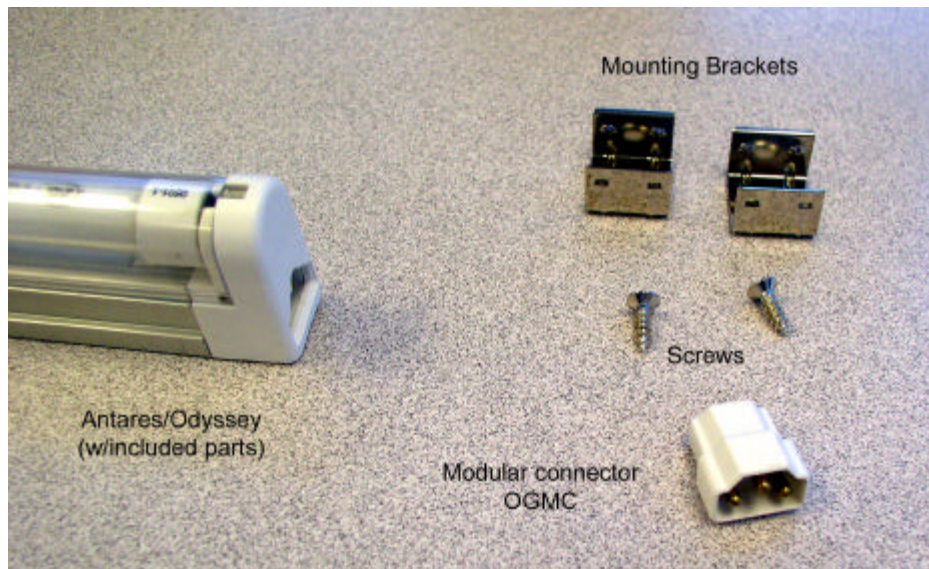

<u>Manuf</u>	<u>Model</u>	<u>Part #</u>	<u>Lamp</u>	<u>Length</u>	<u>Width</u>	<u>Height</u>
Antares	Odyssey	OT413	F8T4	13 3/8"	3/4"	1 3/8"
Antares	Odyssey	OT417	F12T4	17 3/8"	3/4"	1 3/8"
Antares	Odyssey	OT421	F20T4	21"	3/4"	1 3/8"
Antares	Odyssey	OT429	F22T4	29"	3/4"	1 3/8"
Antares	Odyssey	OT440	F26T4	40 1/4"	3/4"	1 3/8"
Antares	Odyssey	OT446	F28T4	46 1/4"	3/4"	1 3/8"

**Accessories for Antares fixtures**



**3PT18** 18" pig tail  
**3PT36** 36" pig tail



**3LC02** 2" link cord  
**3LC06** 6" link cord  
**3LC12** 12" link cord  
**3LC24** 24" link cord  
**3LC36** 36" link cord  
**3LC72** 72" link cord



**3PC6** 6' power cord  
**3PC12** 12' power cord  
**3PC6SW** 6' power cord with rocker switch

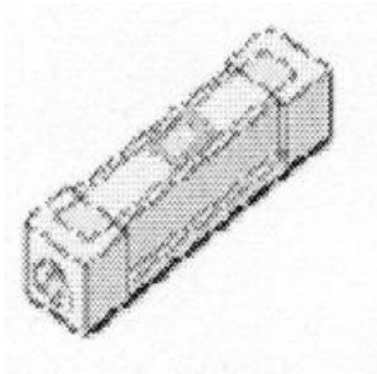

**OGSW**  
power rocker switch

Click below to order

**Interlight Specialty Bulbs**  
**1-800-743-0005**  
**www.interlight.biz**

Interlight Specialty Bulbs  
 1-800-743-0005  
[www.interlight.biz](http://www.interlight.biz)

**Hera**  
**Slimlite XL T5 Fixtures**

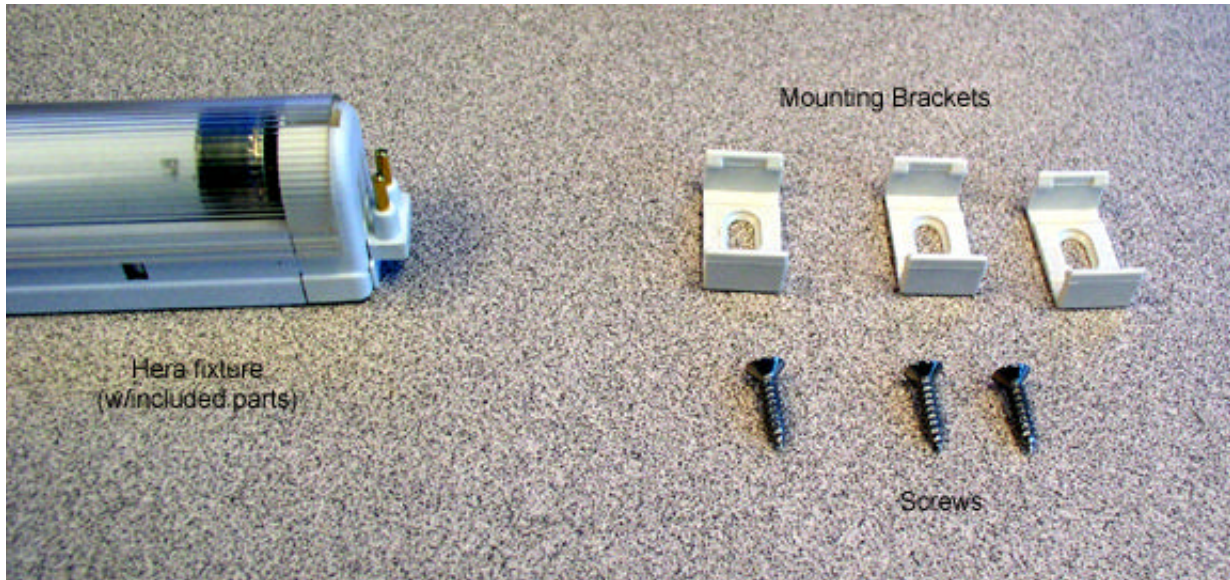

<u>Manuf</u>	<u>Model</u>	<u>Part #</u>	<u>Lamp</u>	<u>Length</u>	<u>Width</u>	<u>Height</u>
Hera	Slimlite XL	ES22.BC	F14T5	23 1/8"	29/32"	1 5/16"
Hera	Slimlite XL	ES34.BC	F21T5	34 7/8"	29/32"	1 5/16"
Hera	Slimlite XL	ES46.BC	F28T5	46 3/4"	29/32"	1 5/16"
Hera	Slimlite XL	ES59.BC	F35T5	58 7/16"	29/32"	1 5/16"

**Hera**  
**Slimlite T4 Fixtures**



<u>Manuf</u>	<u>Model</u>	<u>Part #</u>	<u>Lamp</u>	<u>Length</u>	<u>Width</u>	<u>Height</u>
Hera	Slimlite	ES10	F7T4	10"	11/16"	1 1/4"
Hera	Slimlite	ES13	F10T4	13"	11/16"	1 1/4"
Hera	Slimlite	ES20	F18T4	20"	11/16"	1 1/4"

**Accessories for Hera fixtures**

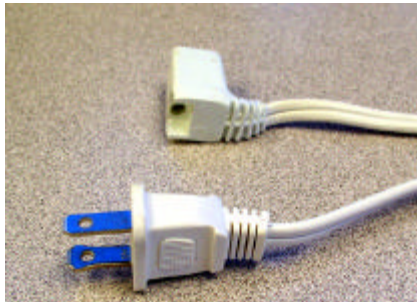

**SPC/XL** 6' power cord  
**SPC/S/XL** 6' power cord with switch



**SCC6/XL** 6" connecting cable  
**SCC12/XL** 1' connect. cable  
**SCC24/XL** 2' connect. cable  
**SCC48/XL** 4' connect. cable  
**SCC72/XL** 6' connect. cable

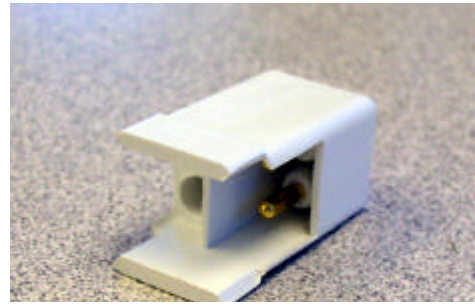

**SDC/XL** direct connector

(Older style fixtures have flat blades instead of pins for power connections. They are available on special order)

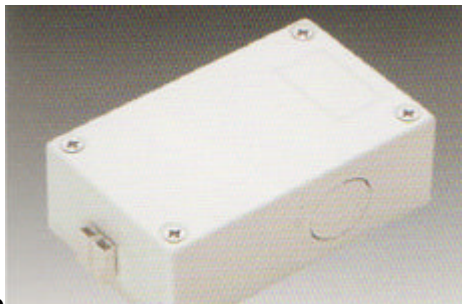

**SHWC/XL** hardwire box  
**SHWC/S/XL** hardwire box w/switch



**SRS/XL** on/off rocker Switch

(Other special order configurations shown below)



**SPC18/SP** power cord



**SPC15/STC** power cord



**SPC18/STC/F** power cord



**SCC6/SP** connecting cord



**SCC24/STC** connecting cord



**SCC6/STC/F** connecting cord

Interlight Specialty Bulbs  
 1-800-743-0005  
[www.interlight.biz](http://www.interlight.biz)

**SUNPARK  
 T5 Ultra-Slim**

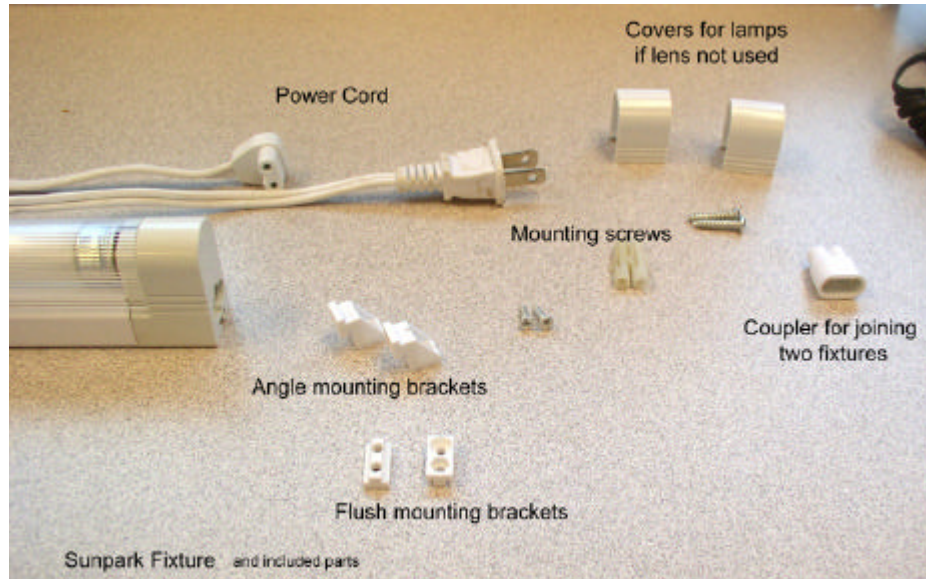

<u>Manuf</u>	<u>Model</u>	<u>Part #</u>	<u>Lamp</u>	<u>Length</u>	<u>Width</u>	<u>Height</u>
Sunpark	T5 Ultra-Slim	YGLLD-8	F8T5	13 7/16"	7/8"	1 5/8"
Sunpark	T5 Ultra-Slim	YGLLD-13	F13T5	22 1/2"	7/8"	1 5/8"
Sunpark	T5 Ultra-Slim	YGLLD-14	F14T5	23 3/4"	7/8"	1 5/8"
Sunpark	T5 Ultra-Slim	YGLLD-21	F21T5	35 9/16"	7/8"	1 5/8"
Sunpark	T5 Ultra-Slim	YGLLD-28	F28T5	47 3/8"	7/8"	1 5/8"

**Accessories for Sunpark fixtures**



Linkable power cord

# Electronic Freezer Ballasts

REPLACEMENTS FOR ANTHONY / ARDCO AND HUSSMAN

Click below to order

Interlight Specialty Bulbs  
1-800-743-0005  
[www.interlight.biz](http://www.interlight.biz)



Section	Page(s)
Electronic Freezer Ballasts	
BC12040	48
BC24040	48
BC12070	49
BC12060	49



**BC120-2/40LT**

9.75" x 1.58" x 1.07"

**For one or two F32T8 or F40T8 lamps @ 120v**

This is a "hardwire" ballast it has no plugs or connectors

\*\*\*Replaces the following Anthony ballasts\*\*\*

1158R*	60-12953-0002	60-13158-0001	AE-12226*	EL-58260-A*
1258R*	60-12954-0001	60-13158-0002	AE-12227-S*	ELF01R
60-12213-0001	60-12954-0002	60-13159-0001	AE-12240-C*	ELF02R
60-12227-0001	60-12955-0001	60-13160-0001	AE-12241-C*	ELF04R
60-12544-0001	60-12955-0002	60-13160-0002	AE-12242*	ELF8260-A*
60-12950-0001	60-12956-0001	60-13255-0002	AE-12243-S*	LT1X40/120
60-12950-0002	60-12956-0002	60-13258-0002	EL-58148-A*	LT1X40/MULTI*
60-12952-0001	60-13077-0002	AE12212-C*	EL-58160-A*	LT2X40/120
60-12952-0002	60-13079-0002	AE-12213-C*	EL-58248-A*	LT2X40/MULTI*
60-12953-0001				

\*when used on 120v

\*\*\*Replaces the following Ardcoc ballast\*\*\*

C15724 P8

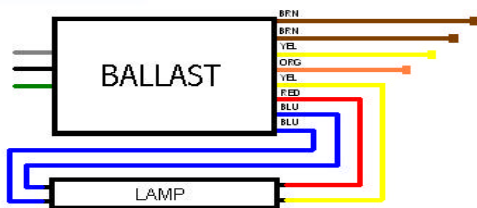

One light operation

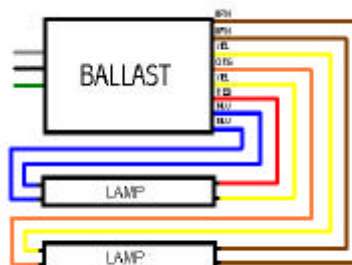

Two light operation



**BC240-2/40LT**

9.75" x 1.58" x 1.07"

**For one or two F32T8 or F40T8 lamps @ 240v**

This is a "hardwire" ballast it has no plugs or connectors

\*\*\*Replaces the following Anthony ballasts\*\*\*

1158R*	AE-12226*	AE-12242*	EL-58248-A*	LT1X40/MULTI*
1258R*	AE-12227-S*	AE-12243-S*	EL-58260-A*	LT2X40/220
AE12212-C*	AE-12240-C*	EL-58148-A*	ELF8260-A*	LT2X40/MULTI*
AE-12213-C*	AE-12241-C*	EL-58160-A*	LT1X40/220	*when used on 220v

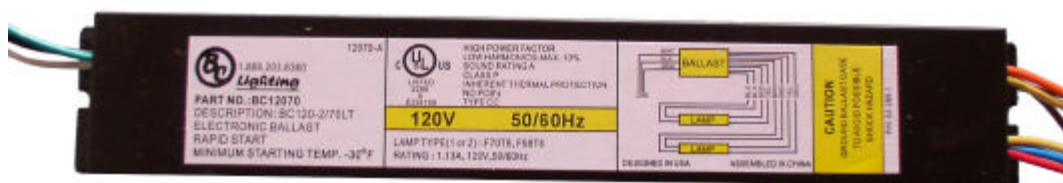

**BC120-2/70LT**

9.75" x 1.58" x 1.07"

For one or two F58T8 or F70T8 lamps @ 120v

This is a "hardwire" ballast it has no plugs or connectors

\*\*\*Replaces the following Anthony ballasts\*\*\*

1158R*	60-12953-0003	60-13077-0003	AE-12270-C*	EL-5872-A*
1170R*	60-12954-0003	60-13078-0003	AE-12271-C*	LT1X70/120
1258R*	60-12955-0003	60-13079-0003	AE-12272*	LT1X70/MULTI*
60-12213-0003	60-12956-0003	60-13158-0003	AE-12273-S*	LT2X70/120
60-12950-0003	60-13076-0003	60-13159-0003	EL-58172-A*	LT2X70/MULTI*
60-12952-0003	60-13076-0004	60-13160-0003	*when used on 120v	

\*\*\*Replaces the following Ardcoc ballast\*\*\*

C15724 P12      C15751 P002

\*\*\*Replaces the following Hussmann ballast\*\*\*

0430330      0425671

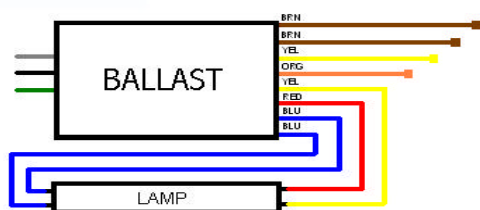

One light operation

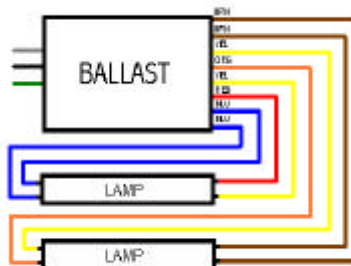

Two light operation

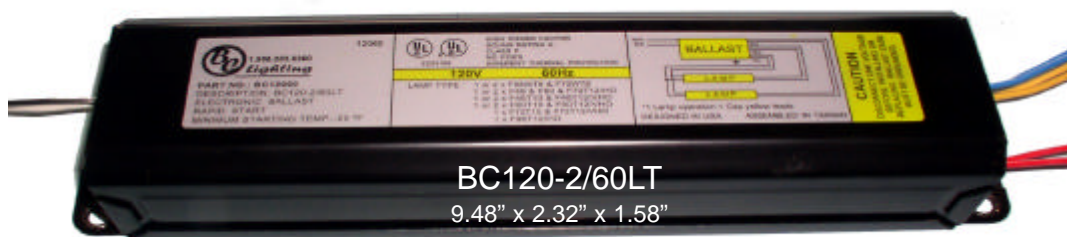

**BC120-2/60LT**

9.48" x 2.32" x 1.58"

\*\*\*Replaces the E260SVH120 and E172SVH120\*\*\*

1-F58T8	2-F48T12/VHO	1-F60T12/HO	2-F60T12/HO	1-F60T10
2-F58T8				2-F60T10
1-F70T8				1-F60T12/VHO
2-F70T8				2-F60T12/VHO
1-F48T12/HO				1-F72T12/HO
2-F48T12/HO				2-F72T12/HO
1-F48T10				1-F72T10
2-F48T10				1-F72T12/VHO
1-F48T12/VHO				1-F96T12/HO

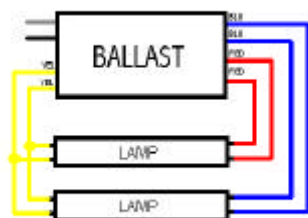

\*Individually cap unused leads

## Ardco 800 replacement

**Ardco 800**

**WH5-230L**

Wiring can all be done in ballast compartment

Power must be turned off before commencing

1. Red wire that was going directly to the Ardco goes to Black on the WH5
2. Red wire that goes to lamp gets cut in two - hot side goes to White on WH5
3. The other side of the Red wire gets joined to the black that was going from the capacitor to the lamp and to the yellow on the WH5. (capacitor gets removed)
4. The two Blue wires get joined together and then to any three of the Red WH5 wires
5. Remaining Red wire gets capped off.

## Husmann Replacements

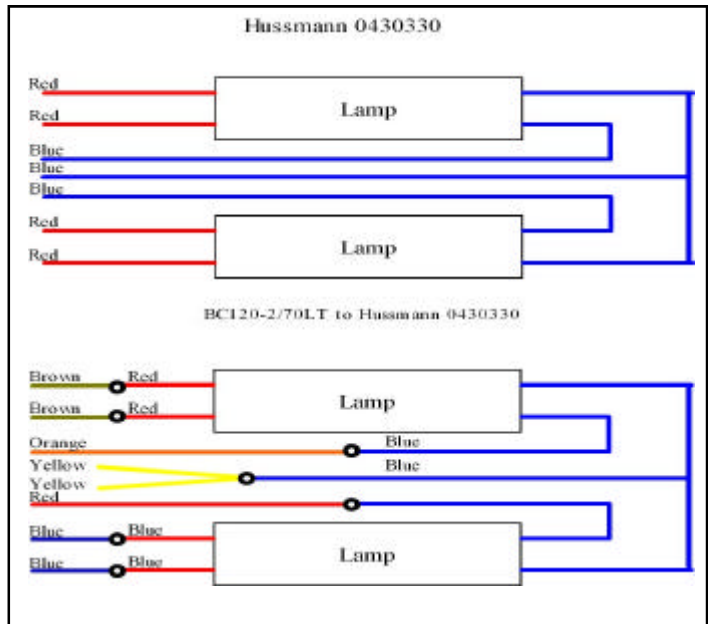
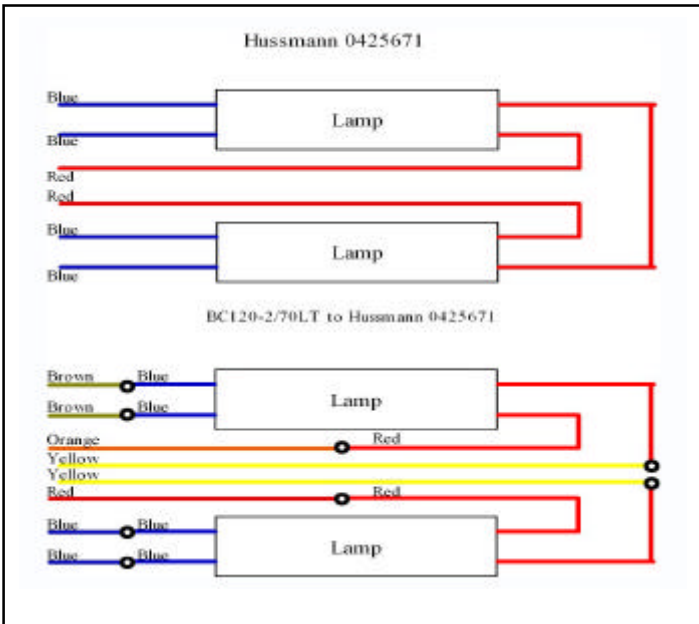

Click below to order

Interlight Specialty Bulbs  
1-800-743-0005  
[www.interlight.biz](http://www.interlight.biz)

# Workhorse Ballasts

MULTIPLE APPLICATION BALLASTS

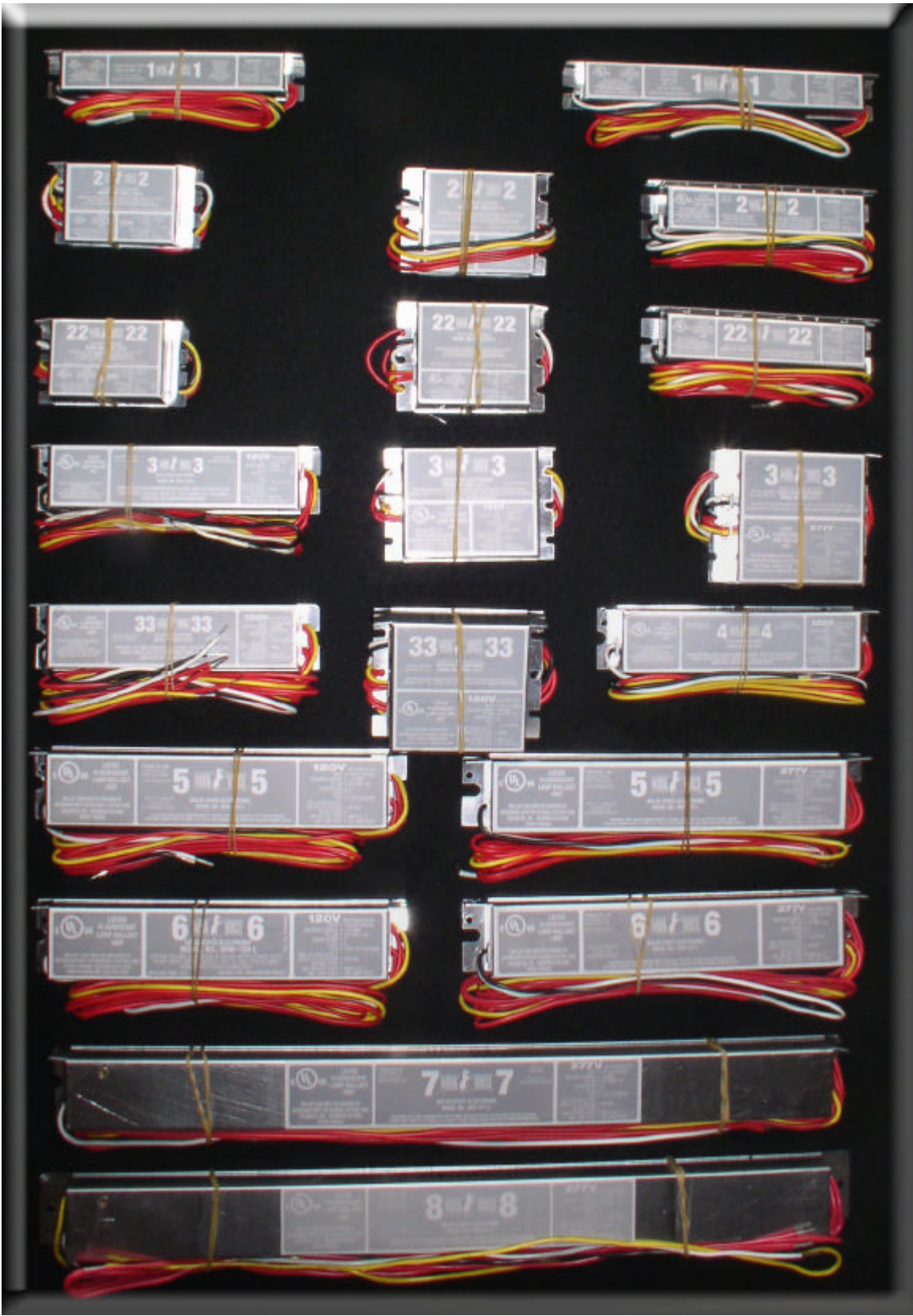



**WH1-120L**  
(0.75" x 1.0" x 5.9")

**WH1-277L**  
(0.75" x 1.0" x 7.5")



**WH2-120-L**  
(1.2" x 1.0" x 5.5")

**WH2-120-C**  
(1.8" x 1.0" x 3.3")  
**WH2-120-BLS**  
(1.8" x 1.0" x 3.3")  
w/bottom exit & studs

**WH2-277-C**  
(2.3" x 1.0" x 3.4")  
**WH2-277-BLS**  
(2.3" x 1.0" x 3.4")  
w/bottom exit & studs

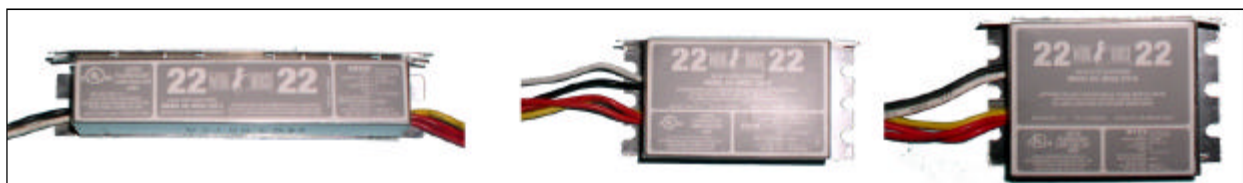

**WH22-120-L**  
(1.2" x 1.0" x 5.5")  
**WH22-277-L**  
(1.2" x 1.0" x 5.5")

**WH22-120-C**  
(1.8" x 1.0" x 3.3")  
**WH22-120-BLS**  
(1.8" x 1.0" x 3.3")  
w/bottom exit & studs

**WH22-277-C**  
(2.3" x 1.0" x 3.4")  
**WH22-277-BLS**  
(2.3" x 1.0" x 3.4")  
w/bottom exit & studs

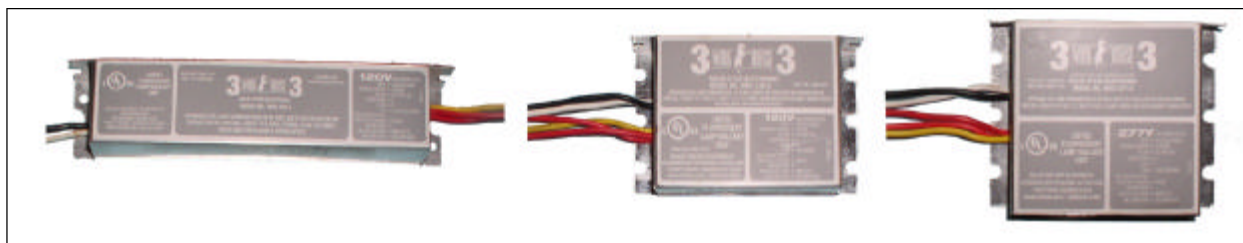

**WH3-120-L**  
(1.5" x 1.0" x 6.5")  
**WH3-277-L**  
(1.5" x 1.0" x 6.5")

**WH3-120-C**  
(2.5" x 1.0" x 3.8")  
**WH3-120-BLS**  
(2.5" x 1.0" x 3.8")  
w/bottom exit & studs

**WH3-277-C**  
(3.1" x 1.0" x 3.8")  
**WH3-277-BLS**  
(3.1" x 1.0" x 3.8")  
w/bottom exit & studs

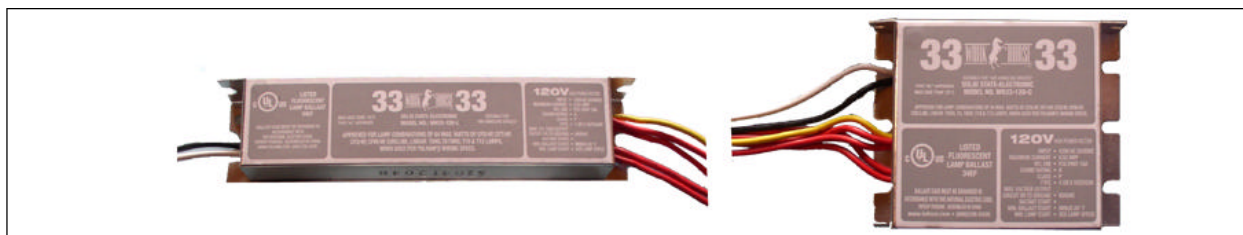

**WH33-120-L**  
(1.5" x 1.0" x 6.5")  
**WH33-277-L**  
(1.5" x 1.0" x 6.5")

**WH33-120-C**  
(3.1" x 1.0" x 3.8")  
**WH33-120-BLS**  
(3.1" x 1.0" x 3.8")  
w/bottom exit & studs

**WH33-277-C**  
(3.1" x 1.0" x 3.8")  
**WH33-277-BLS**  
(3.1" x 1.0" x 3.8")  
w/bottom exit & studs

Interlight Specialty Bulbs  
1-800-743-0005  
[www.interlight.biz](http://www.interlight.biz)



**WH4-120-L**  
(1.5" x 1.0" x 6.5")

**WH4-277-L**  
(1.5" x 1.0" x 6.5")

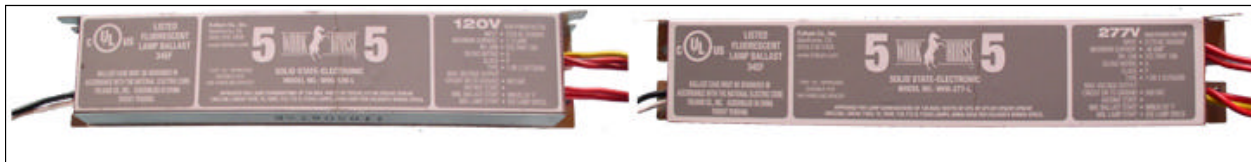

**WH5-120-L**  
(1.7" x 1.0" x 8.5")

**WH5-277-L**  
(1.7" x 1.0" x 9.5")



**WH6-120-L**  
(1.7" x 1.0" x 8.5")

**WH6-277-L**  
(1.7" x 1.0" x 9.5")



**WH7-120-L**  
(1.7" x 1.0" x 18.3")

**WH7-277-L**  
(1.7" x 1.0" x 18.3")

















**WH8-120-L**  
(1.7" x 1.0" x 18.3")

**WH8-277-L**  
(1.7" x 1.0" x 18.3")

Interlight Specialty Bulbs  
 1-800-743-0005  
[www.interlight.biz](http://www.interlight.biz)

**4-pin Twin Tube / Long Twin Tube**

Wiring diagrams pg. 62-63

Wattage	# of lamps	WH1	WH2	WH22	WH3	WH33	WH4	WH5	WH6	WH7	WH8
		Wiring diagram number									
 5w	1	3	2				2				
	2		1	1			1		9		
	3								8		
	4					7		7	7		
 7w	1	3	2								
	2		1				1		9		
	3								8		
	4								7		
 9w	1	3	2								
	2		1				1				
	3								8		
	4								7		
 13w	1		3	2	2		2		14		
	2			1	1	9		9	11		
	3					8		8			
	4					7		7			
 18w	1		3	2	2	14	2		14		
	2			1	1	9		9	9		
	3					8		8			
	4							7			
 24w	1		3	2	2	14	3	14	14		
	2				1	9		9	11		
	3					8					
 27w	1		3	2	2	14	3	14	14		
	2					9		9	11		
	4									7	
 28w Panasonic	1			3	3	14		14	10		
	2					11		11			
	3									8	
	4									7	
 36/39w	1			2	2	14	3	14	10		
	2							9	11		22
	3									8	25
	4									7	27
	5										28
	6										
 40w	1				2	14	2		14		
	2							9	11		
	3							8			25
	4									7	27
	5										28
 50w	1				3	14	3	14	10		
	2							11	11		22
	3									8	25
	4									7	27
 55w	1				3	10		10	12		16
	2							11		9	
	3									8	26
 55w Panasonic	1					10		12	13	14	
	2									11	23
	3										26
 96w	1							12		14	17
	2									11	24

Interlight Specialty Bulbs  
 1-800-743-0005  
 www.interlight.biz

**4-pin Flat Quad**

Wiring diagrams pg. 62-63

Wattage	# of lamps	WH1	WH2	WH22	WH3	WH33	WH4	WH5	WH6	WH7	WH8
<b>Wiring diagram number</b>											
18w 	1		3	2	2	14	3	14	14		
	2					9		9	11		
	3							8			
18w Panasonic	4									7	
	24w	1		3	2	2	14	3		14	
		2				1	9		9	11	
28w Panasonic	3							8			
	1				3	10		10	13		
	2									9	
36w	1				2	14	3	14	10		
	2					9		9	11		
	3										25
	4									7	
55w Panasonic	1					10		12	13	14	
	2										
96w Panasonic	1							12		14	
	2									11	

**4-pin Quad**

Wiring diagrams pg. 62-63

Wattage	# of lamps	WH1	WH2	WH22	WH3	WH33	WH4	WH5	WH6	WH7	WH8
<b>Wiring diagram number</b>											
10w 	1	3	2				2				
	2		1	1			1		9		
	3								8		
	4					7			7		
13w	1	3	2				1				
	2		1						8		
	3								7		
18w	4										
	1	3	2				2				
	2				1		1		9		
	3					8		8	8		
26w	4							7			
	1		3	2	2	14	3		14		
	2				1	9		9	11		
	3							8			
27w Panasonic	4							7			
	1					10		10	13	14	
	2									9	

**4-pin Triple**

Wiring diagrams pg. 62-63

Wattage	# of lamps	WH1	WH2	WH22	WH3	WH33	WH4	WH5	WH6	WH7	WH8
<b>Wiring diagram number</b>											
13w 	1	3	2				1				
	2		1						8		
	3								7		
18w	4										
	1	3	2		1		2		9		
	2					8			8		
26w	3							7			
	4										
	1		3	2	2	14	3		14		
32w	2					9		9	11		
	3							8			
	4							7			
42w	1		3	2	2	14	3	14	14		
	2					9		9	11		
	3							8			
	1				2	14	3	14	14		
	2							9	11		
	3							8			

Interlight Specialty Bulbs  
 1-800-743-0005  
 www.interlight.biz

**4-pin 2-D**

Wiring diagrams pg. 62-63

Wattage	# of lamps	WH1	WH2	WH22	WH3	WH33	WH4	WH5	WH6	WH7	WH8
		Wiring diagram number									
10w	1	3	2								
	2		1				1		9		
	3								8		
	4								7		
16w	1	3	2				2				
	2			1					9		
	3								8		
	4					7	2	7	7		
21w	1		2				2				
	2				1				9		
	3					8		8	8		
	4							7			
28w	1		3	2	2		2		14		
	2				1	9		9	11		
	3							8			
	4							7			
38w	1				2	14	3	14	14		
	2							9	11		
	4									7	
55w	1					12		12		14	
	2									11	

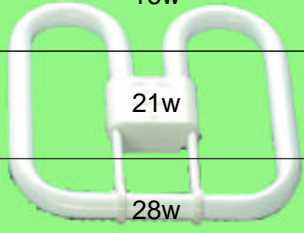

**Circline**

Wiring diagrams pg. 62-63

Wattage	# of lamps	WH1	WH2	WH22	WH3	WH33	WH4	WH5	WH6	WH7	WH8
		Wiring diagram number									
20w	1		3	2	2	14	3	14	14		
	2					9		9	11		
	3									7	
22w	1		3	2	2	14	3	14	14		
	2					9		9	11		
	4									7	
32w	1			3	3	14		14	10		
	2					11		11			
	3									8	
	4									7	
40w	1				2	14	3	14	10		
	2							9	11		
	4									7	
1-22+32w 1-32+40w	1				1			9	11		
	1							11			



**T5 Circline**

Wiring diagrams pg. 62-63

Wattage	# of lamps	WH1	WH2	WH22	WH3	WH33	WH4	WH5	WH6	WH7	WH8
		Wiring diagram number									
22w	1		3	2	2	14	3		14		
	2					9		9	11		
	3					8		8			
40w	1				2	14	3	14	14		
	2							9	11		
55w Osram	1				3	10			12		
	2							11		9	
1-22+40	1				1			9	11		

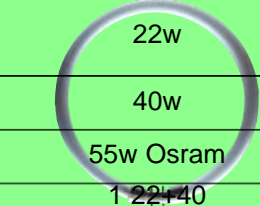

Interlight Specialty Bulbs

1-800-743-0005

www.interlight.biz

**T2 Linear**

Wiring diagrams pg. 62-63

Wattage	# of lamps	WH1	WH2	WH22	WH3	WH33	WH4	WH5	WH6	WH7	WH8
Wiring diagram number											
F6T2	1	2									
	2	1									
F8T2	1	2									
	2	1									
F11T2	1	2									
	2	1									
F13T2	1	2									
	2	1									

**T5 Linear**

Wiring diagrams pg. 62-63

Wattage	# of lamps	WH1	WH2	WH22	WH3	WH33	WH4	WH5	WH6	WH7	WH8
Wiring diagram number											
F4T5	1	3	2								
	2		1				1				
	3								8		
	4								7		
F6T5	1	3	2								
	2		1				1				
	3								8		
	4								7		
F8T5	1	2	2								
	2		1				1				
	3										
	4								7		
F13T5	1	3	2								
	2		1				1				
	3								8		
	4								7		
F14T5	1	3	2								
	2		1				1				
	3								8		
	4								7		
F21T5	1	3	2								
	2		1				1				
	3								8		
	4								7		
F28T5	1	3	2								
	2						1				
	3								8		
	4								7		
F35T5	1		2								
	2						1				
	3								8		
	4								7		

**T5 HO Linear**



Wiring diagrams pg. 62-63

Wattage	# of lamps	WH1	WH2	WH22	WH3	WH33	WH4	WH5	WH6	WH7	WH8
Wiring diagram number											
F24T5/HO	1		3	2	2	14	3		14		
	2				1	9		9	11		
	3							8			
	4							7			27
	5										28
	6										
F39T5/HO	1				2	14	3	14	14		
	2							9	11		
	3							8			25
	4									7	27
	5										28
F54T5/HO	1				3	14		14	12		16
	2							11			22
	3									8	25
	4									7	
F80T5/HO	1							10	12		16
	2									9	

Interlight Specialty Bulbs  
 1-800-743-0005  
[www.interlight.biz](http://www.interlight.biz)

**T6 Linear**

Wiring diagrams pg. 62-63

Wattage	# of lamps	WH1	WH2	WH22	WH3	WH33	WH4	WH5	WH6	WH7	WH8
 F42T6	1	3	2				2				
	2				1		1		9		
	3								8		
	4								7		
 F64T6	1						2				
	2						1		9		
	3								8		

**T8 Linear**

Wiring diagrams pg. 62-63

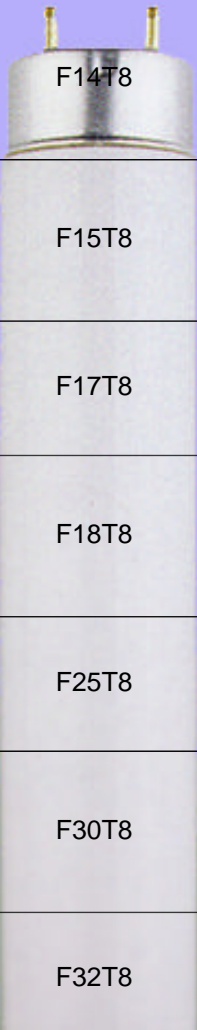
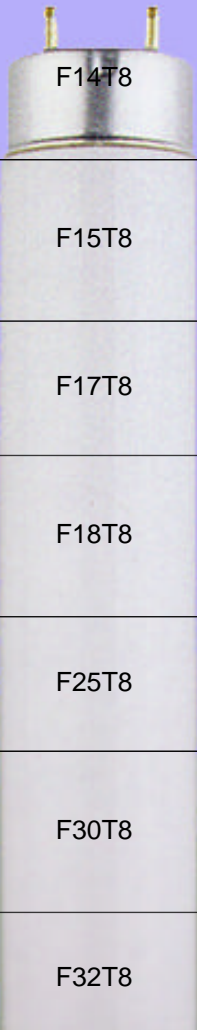
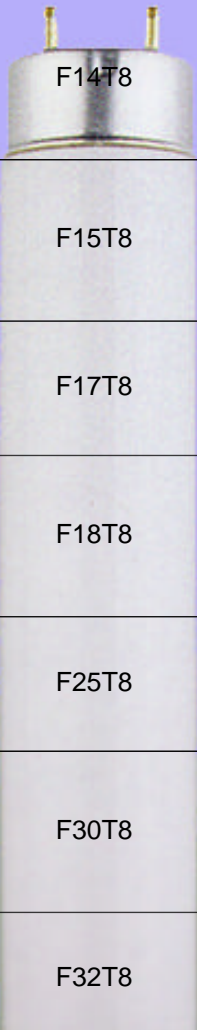
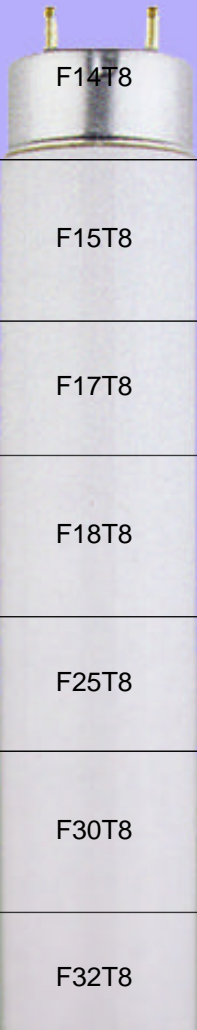
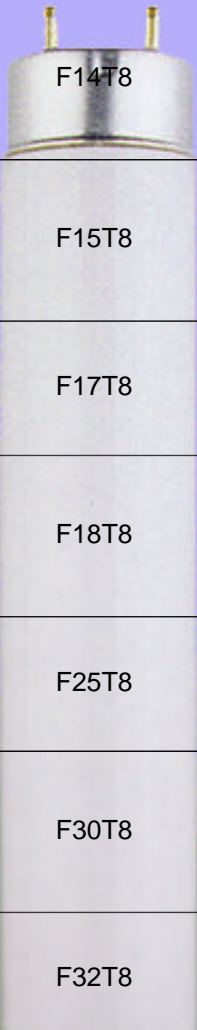
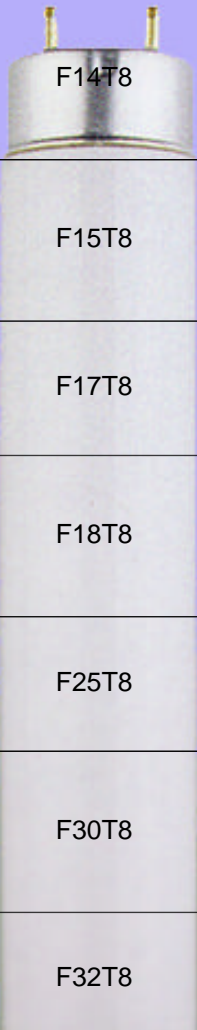
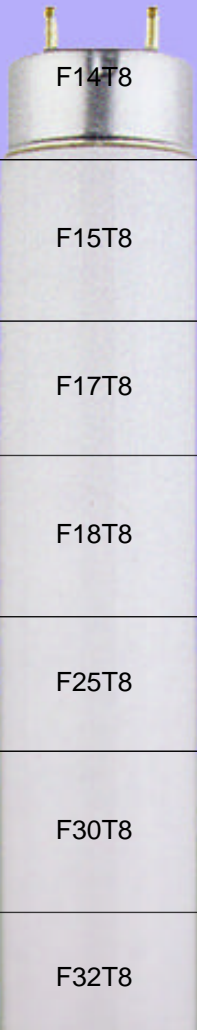
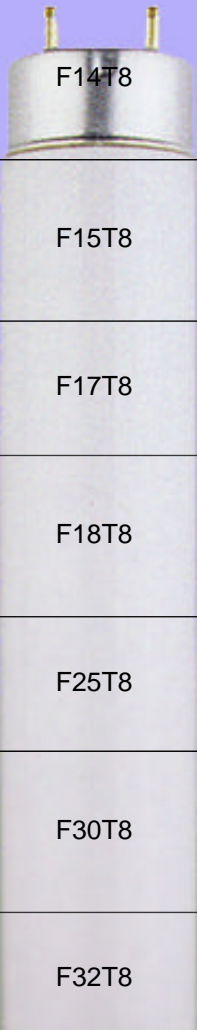
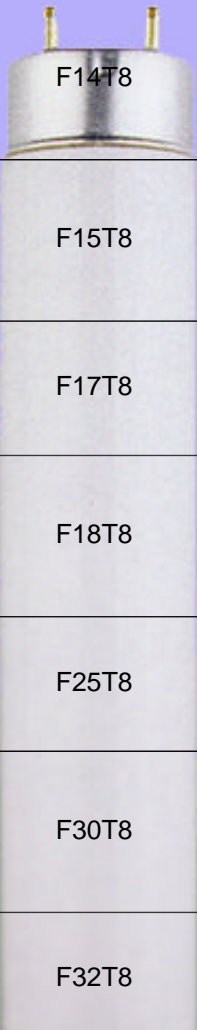
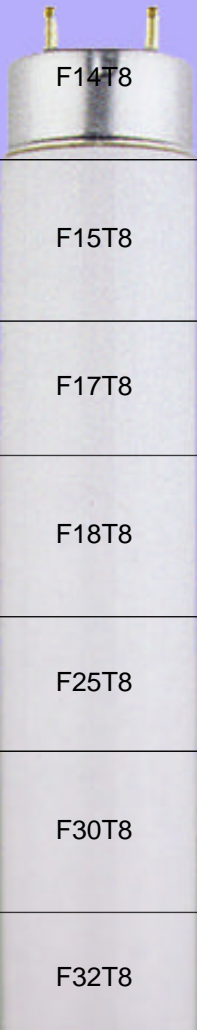
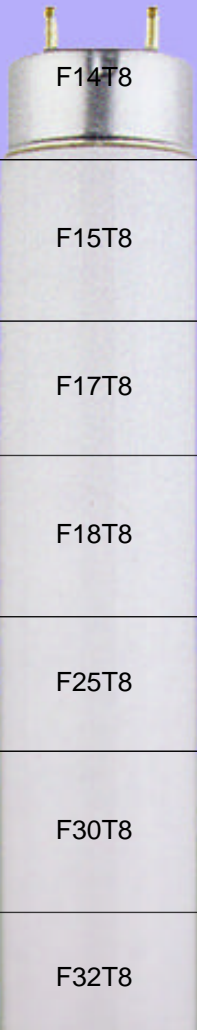
Wattage	# of lamps	WH1	WH2	WH22	WH3	WH33	WH4	WH5	WH6	WH7	WH8
 F13T8	1		3	2	2	14	3		14		
	2				1	9		9	11		
	3					8		8			
	4									7	27
	5										28
	6										
 F14T8	1		3	2	2	14	3	14	14		
	2					9		9	11		
	3					8					25
	4									7	27
	5										28
	6										
 F15T8	1		3	2	2		3		14		
	2			1	1	9		9	11		
	3					8		8			
	4					7		7			
	5										28
	6										
 F17T8	1		3		2		2				
	2			1	1				9		
	3					8		8			
	4					7		7			
	6										29
	 F18T8	1		3	2	2	14	3		14	
2						9		9	11		
3								8			25
4											27
5											28
6											
 F25T8	1		3		2		2				
	2				1				9		
	3							8			
	4							7			
	6										29
	 F30T8	1		3	2	2	14	3		14	
2						9		9	11		
3								8			25
4										7	27
5											28
6											
 F32T8	1		3		2		2				
	2				1				9		
	3							8			
	4							7			
	6										29
	 F40T8	1				2		2			
2									9		
3								8			
 F58T8	1								10		
	2							11			22
	3									8	
 F70T8	1								10		
	2							11			22

Interlight Specialty Bulbs  
 1-800-743-0005  
[www.interlight.biz](http://www.interlight.biz)

**T8 Linear (cont.)**

Wiring diagrams pg. 62-63

Wattage	# of lamps	WH1	WH2	WH22	WH3	WH33	WH4	WH5	WH6	WH7	WH8
 F72T8	1	Wiring diagram number									
	2						2				
	3						1		9		
	4								8		
									7		

**T8 HO**

Wiring diagrams pg. 62-63

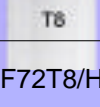
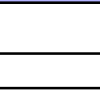
Wattage	# of lamps	WH1	WH2	WH22	WH3	WH33	WH4	WH5	WH6	WH7	WH8
 F48T8/HO	1				3	14		14	10		
	2							11			22
	3									8	25
	4									7	27
 F60T8/HO T8	1				3	14		14	10		
	2							11			22
	3									8	25
	4									7	27
 F72T8/HO	1				3	14		14	10		
	2										22
	3							11		8	25

**T10 Linear**

Wiring diagrams pg. 62-63

Wattage	# of lamps	WH1	WH2	WH22	WH3	WH33	WH4	WH5	WH6	WH7	WH8
 F40T10	1				3	14	3	14	10		
	2							11	11		22
	3									8	25
	4									7	27
	5										28

**T10/VHO Linear**

Wiring diagrams pg. 62-63

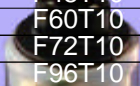
Wattage	# of lamps	WH1	WH2	WH22	WH3	WH33	WH4	WH5	WH6	WH7	WH8
 F48T10 F60T10 F72T10 F96T10	1									12	19
	1									12	19
	1									12	19
	1									12	19

**T12 Linear**







Wiring diagrams pg. 62-63

Wattage	# of lamps	WH1	WH2	WH22	WH3	WH33	WH4	WH5	WH6	WH7	WH8
 F14T12 F15T12 T12 F20T12	1		3	2	2	14	3	14	10		
	2					9		9	11		
	3										25
	4									7	27
	5										28
	6										29
	1		3	2	2		3		14		
	2				1	9		9	11		
	3					8		8			27
	4							7			28
	5										29
	6										
	1		3	2	2	14	3	14	14		
	2					9		9	11		
	3										25
	4									7	27
	5										28
	6										29

Interlight Specialty Bulbs  
 1-800-743-0005  
[www.interlight.biz](http://www.interlight.biz)

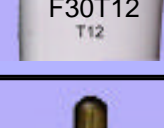
**T12 Linear (cont.)**

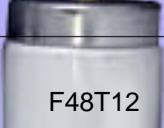
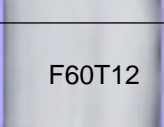
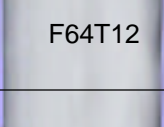
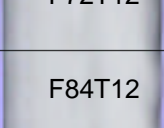
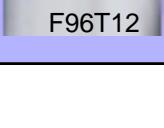
Wiring diagrams pg. 62-63

Wattage	# of lamps	WH1	WH2	WH22	WH3	WH33	WH4	WH5	WH6	WH7	WH8
Wiring diagram number											
	1			3		14	3	14	10		
	2					11		11	11		22
	3									8	25
	4									7	27
	5										28
	1			3	3	14		14	10		
	2					11		11			22
	3									8	25
	4									7	27
	1			3	3	14	3	14	10		
	2					11		11	11		22
	3									8	25
	4									7	27
	5										28
	1				3	14	3	14	10		
	2					11		11	11		22
	3									8	25
	4									7	27
	5										28
	1				3	14	3	14	10		
	2							11	11		22
	3									8	25
	4									7	27
	5										28
	1				3	14	3	14	10		
	2							11	11		22
	3									8	25
	4									7	27
	5										28
	1				3	1	3	14	10		
	2							11	11		22
	3									8	25
	4									7	27
	5										28
	1				2	14	3	14	10		
	2							11	11		22
	3									8	25
	4									7	27
	1				2	14	3	14	10		
	2							11	11		22
	3									8	25
	4										27
	1				2	14	3	14	10		
	2							11	11		22
	3									8	25
	4										27
	1				2		3	14	10		
	2							11	11		22
	3									8	25
	1							14	10		
	2							9	11		22
	3									8	

<b>T12 HO Linear</b>											Wiring diagrams pg. 62-63	
<b>Wattage</b>	<b># of lamps</b>	<b>WH1</b>	<b>WH2</b>	<b>WH22</b>	<b>WH3</b>	<b>WH33</b>	<b>WH4</b>	<b>WH5</b>	<b>WH6</b>	<b>WH7</b>	<b>WH8</b>	
<b>Wiring diagram number</b>												
F18T12/HO	1					12		12	13	14		
	2									11	23	
	3										26	
F24T12/HO	1					12		12	13	14		
	2									11	23	
	3										26	
F30T12/HO	1					12		12	13	14		
	2									11	23	
	3										26	
F36T12/HO	1					12		12	13	14		
	2									11	23	
	3										26	
F42T12/HO	1					12		12	13	14		
	2									11	23	
	3										26	
F48T12/HO	1					12		12	13	14		
	2									11	23	
	3										26	
F60T12/HO	1							12	13	14		
	2									11	23	
	3										26	
F64T12/HO	1							12	13	14		
	2									11	23	
F72T12/HO	1							12	13	14		
	2									11	23	
F84T12/HO	1							12	13	14		
	2										23	
F96T12/HO	1							12	13	14		
	2										23	

<b>T12 VHO Linear</b>											Wiring diagrams pg. 62-63	
<b>Wattage</b>	<b># of lamps</b>	<b>WH1</b>	<b>WH2</b>	<b>WH22</b>	<b>WH3</b>	<b>WH33</b>	<b>WH4</b>	<b>WH5</b>	<b>WH6</b>	<b>WH7</b>	<b>WH8</b>	
<b>Wiring diagram number</b>												
F48T12/VHO	1									12	19	
F60T12/VHO	1									12	19	
F72T12/VHO	1									12	19	
F96T12/VHO	1									12	19	

Click below to order

**Interlight Specialty Bulbs**  
**1-800-743-0005**  
[www.interlight.biz](http://www.interlight.biz)

Interlight Specialty Bulbs  
1-800-743-0005  
[www.interlight.biz](http://www.interlight.biz)

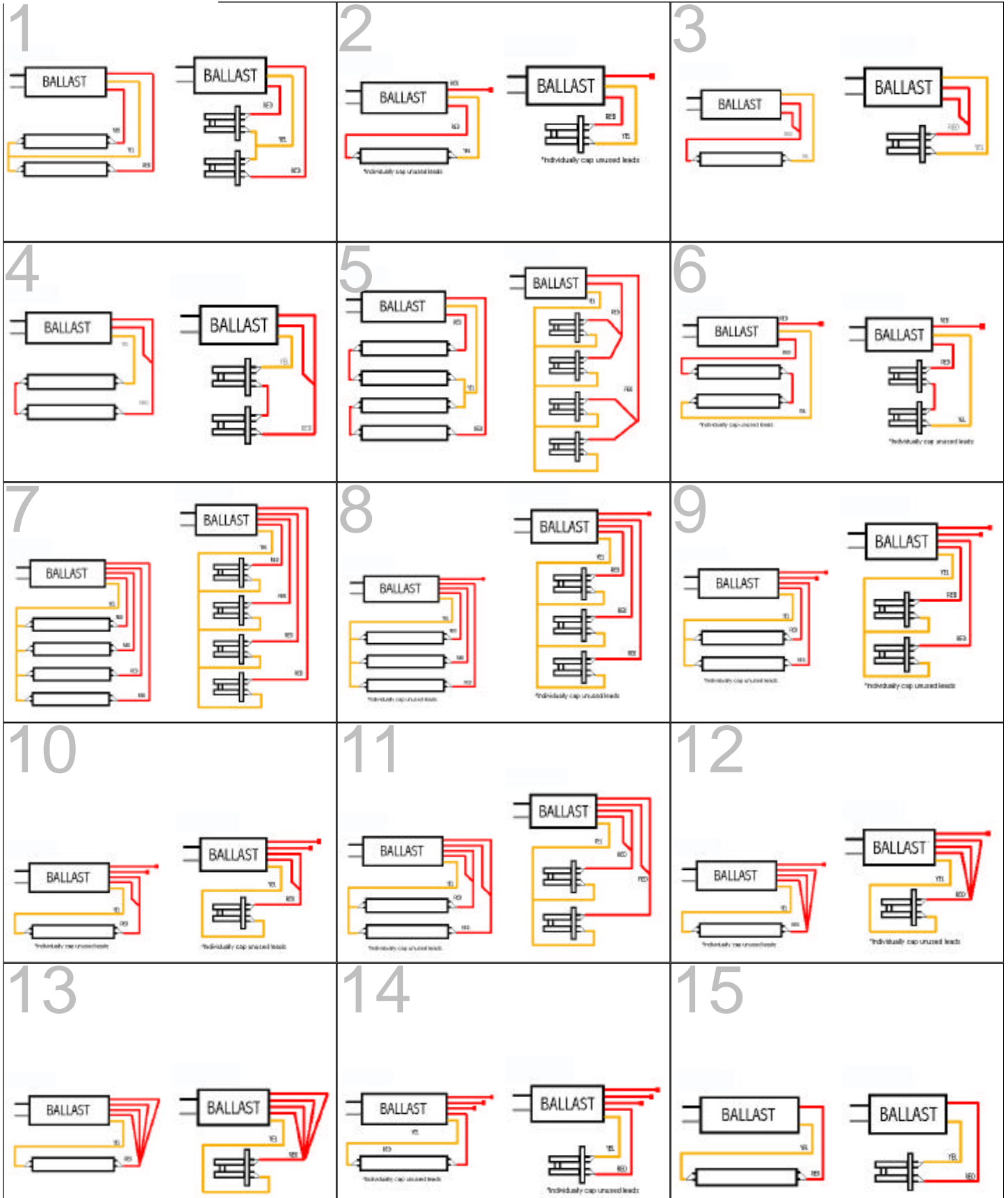



Click below to order

Interlight Specialty Bulbs  
1-800-743-0005  
[www.interlight.biz](http://www.interlight.biz)

# H&M