

2423/V-D1-T

2423/V-D2-T

2423/V-D3-T

PORTALAMPADE PER LAMPADE FLUORESCENTI COMPATTE (TC-D, TC-T)

LAMP HOLDERS FOR COMPACT FLUORESCENT LAMPS (TC-D, TC-T)

Dati tecnici

Technical data





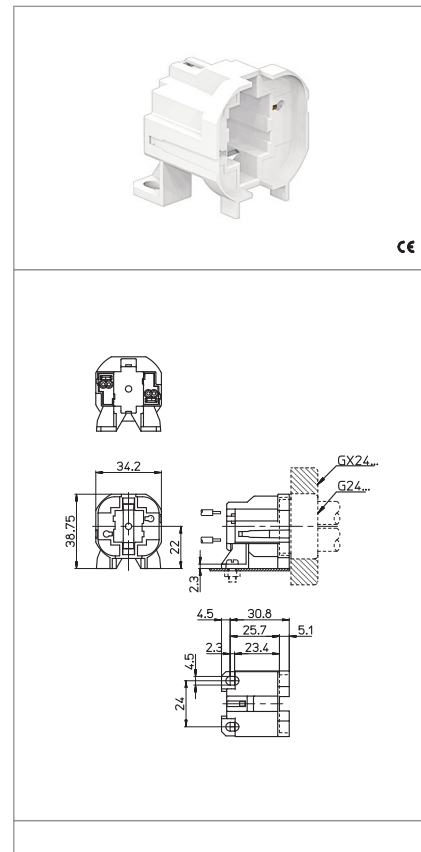

- Attacco lampada - Lamp cap	G24d-1-2-3 GX24d-1-2-3
- Corrente e tensione nominale - Rated current and voltage	2A-500V
- Temperatura massima di funzionamento (IEC) - Maximum operating temperature (IEC)	T140
- Grado di protezione - Protection index	IP20
- Categoria di sovratensione - Impulse withstand category	III

Caratteristiche

Characteristics

- Corpo in PBT bianco
- White PBT body
- Contatti in lega di rame
- Copper alloy contacts



 fissaggio con vite <i>screw fixing</i>	 altezza centro lampada (da sopra la lamiera) <i>lamp centre height</i> (from the top of the metal plate)	 serrafilo automatico a 2 fori <i>push-wire terminals with 2 holes</i>	 sezione conduttore rigido <i>rigid conductor section</i>
 spelatura cavetti rigidi <i>rigid wires stripping</i>	 con fori di guida per i cavetti <i>with wires guidance holes</i>	 isolato in classe II <i>class II insulated</i>	

Marchi di qualità

Quality marks

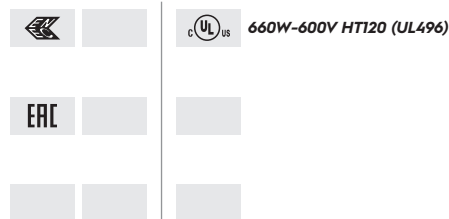

Direttive Europee

European directives

Conforme "RoHS"
"RoHS" compliant
Non soggetto alla "RAEE"
Not subject to "WEEE"

Pesi e confezioni

Weights and packaging

Art. Codice prodotti <i>Product references</i>	g Peso netto <i>Net weight</i>	n° pz per sacco <i>per bag</i>	n° pz per scatola <i>per box</i>	n° pz per cartone <i>per carton</i>
2423/V-d1-T	13	500		
2423/V-d2-T	13	500		
2423/V-d3-T	13	500		

Note

Notes