



MASTER LEDspot ExpertColor AR111



MAS LEDspotLV D 20-100W 940 AR111 24D

MASTER LEDspot LV ExpertColor creates a warm and comfortable ambience for hospitality venues, homes and restaurants. It creates such an ambience with superior lighting that has a customized spectrum, high CRI, and deep dimming feature. The result? A beautiful lighting experience. What's more, the innovative, trimless lens design will suit almost any interior decor with its clean and neat look. In addition, you can take advantage of the full ExpertColor family, which also includes LEDspot MV and LEDspot Par lamps.

Product data

General information	
Cap-Base	G53 [G53]
EU RoHS compliant	Yes
Nominal Lifetime (Nom)	25000 h
Switching Cycle	50000X
Technical Type	20-100W
Flux measurement reference	Narrow Cone
Light technical	
Color Code	940 [CCT of 4000K]
Beam Angle (Nom)	24 °
Luminous Flux (Nom)	1270 lm
Luminous Intensity (Nom)	5000 cd
Color Designation	Cool White (CW)
Correlated Color Temperature (Nom)	4000 K
Luminous Efficacy (rated) (Nom)	63.00 lm/W
Color Consistency	<4
Color Rendering Index (Nom)	91

LLMF At End Of Nominal Lifetime (Nom)	70 %
Luminous Flux in 90° Cone (Rated)	1270 lm
Operating and electrical	
Input Frequency	50 to 60 Hz
Power (Nom)	20 W
Lamp Current (Nom)	2000 mA
Wattage Equivalent	100 W
Starting Time (Nom)	0.5 s
Warm Up Time to 60% Light (Nom)	0.5 s
Power Factor (Nom)	0.7
Voltage (Nom)	ac electronic 12 V
Temperature	
T-Case Maximum (Nom)	97 °C

MASTER LEDspot ExpertColor AR111

Controls and dimming

Dimmable	Only with specific dimmers
----------	----------------------------

Mechanical and housing

Bulb Finish	Clear
Bulb Shape	AR111

Approval and application

Energy Efficiency Class	G
Suitable For Accent Lighting	Yes
Energy Consumption kWh/1000 h	20 kWh
EPREL Registration Number	648256

Product data

Full product code	871869970519000
Order product name	MAS LEDspotLV D 20-100W 940 AR111 24D
EAN/UPC - Product	8718699705190
Order code	929002050702
Numerator - Quantity Per Pack	1
Numerator - Packs per outer box	6
Material Nr. (12NC)	929002050702
Net Weight (Piece)	0.160 kg

Dimensional drawing

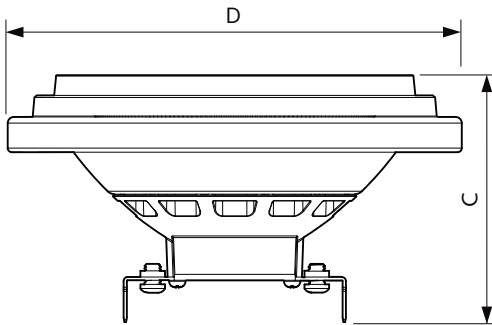

MAS LEDspotLV D 20-100W 940 AR111 24D

Product	D	C
MAS LEDspotLV D 20-100W 940 AR111 24D	111 mm	62 mm

Photometric data

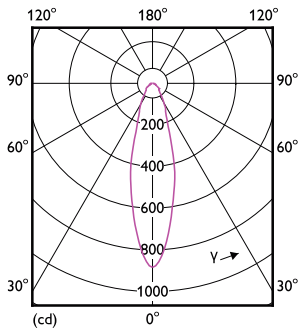

LEDspots MAS SLR 20W AR111 G53 940 24D-LDD LDD

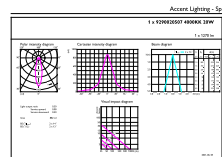

LEDspots MAS SLR 20W AR111 G53 940 24D-ADL ADL

MASTER LEDspot ExpertColor AR111

Photometric data

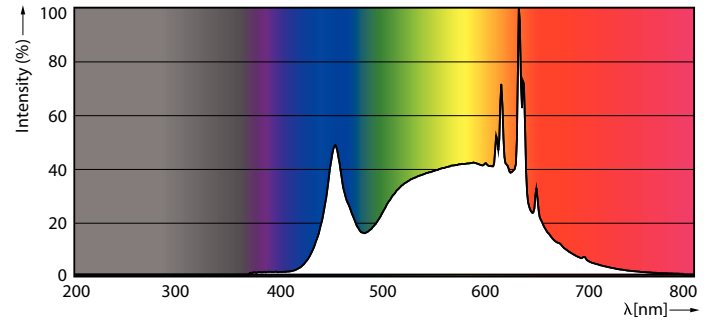
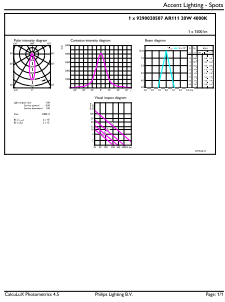

LEDspots 100W G53 AR111 940 24D

LEDspots MAS SLR 20W AR111 G53 940 24D-POC POC

Lifetime

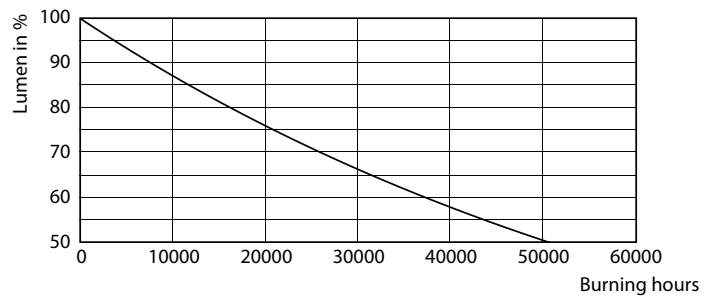
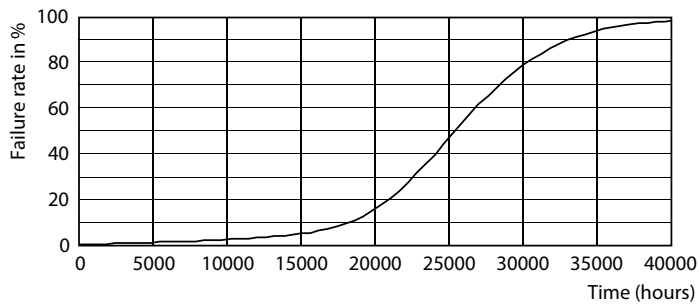

LEDspots LED 25K

LEDspots LMP 25K

