

Pico 4-Button Wireless Remote

The Pico wireless remote is a flexible and easy to use device that allows the user to control Lutron wireless load-control devices from anywhere in the space. This battery-operated control requires no external power or communication wiring.

Features

- Provides control for the following:
 - Vive¹ systems:
 - Maestro Wireless controls
 - Standalone PowPak modules (excluding RM_-ECO32-DV-B)
 - Energi Savr Node systems programmed with handheld App, through the use of a QS sensor module (QSM)²
 - GRAFIK Eye QS wireless systems
 - HomeWorks QS systems
 - HomeWorks QSX systems
 - RadioRA 2 systems
 - RA2 Select systems
 - RadioRA 3
 - Serena RF remote control shades
 - Sivoia QS wireless systems
 - Caséta Wireless controls
 - Quantum systems³, through the use of a QS sensor module (QSM)²
 - Athena systems
 - myRoom XC systems
 - myRoom prime and plus systems
- Custom engraving options.
- Control available in a variety of button marking options.
- Control available in Gloss and Satin Colors finishes.

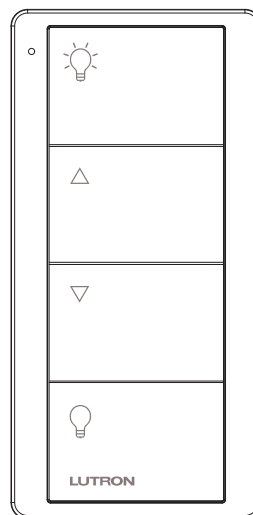

Pico 4-Button Wireless Remote
* Lights zone control printing shown.

- Easy reconfiguration for use as:
 - Handheld remote
 - Wall-mount control (with or without faceplate; faceplate adapter kit sold separately)
 - Car visor control (car visor clip sold separately)
 - Table-top control (table-top pedestal sold separately)
- Utilizes Lutron reliable Clear Connect RF technology.
- Battery-powered. Requires no wiring.
- 10 year battery life⁴ (one CR2032 battery included).
- Can provide control of shades, drapes, or lighting devices within a range of 30 ft (9 m) through walls and 60 ft (18 m) line-of-sight.

¹ Available in Vive Hub software version 01.06.13 or higher.

² Requires Energi Savr Node software version 8.012 or higher.

³ Available in Quantum software version 3.4 or higher.

⁴ Based on a 1 year shelf life, an average of 10 button presses per day, and an ambient temperature of 86 °F (30 °C). Actual life may vary based on usage and environmental conditions.

Job Name:	Model Numbers:
Job Number:	

Specifications

Regulatory Approvals

- Lutron Quality Systems registered to ISO 9001.
- FCC Certified (U.S.A.)
- IC Certified (Canada)
- COFETEL Certified (Mexico)
- NOM Certified (Mexico)
- SUTEL Certified (Costa Rica)
- Anatel Certified (Brazil)

Power

- Operating Voltage 3 V \equiv
- (1) CR2032 battery (included)

System Communication and Capacity

- Communicates using Radio Frequency (RF) at 431 MHz to 437 MHz.
- Thousands of system addresses prevent interference between systems.
- Can be assigned to control shades, drapes, or lighting devices within a range of 30 ft (9 m) through walls and 60 ft (18 m) line-of-sight.

Mounting Considerations

- All RF devices should be mounted on nonmetallic surfaces to ensure proper performance.
- If you wish to mount your Pico wireless remote to a metallic surface, the PICO-MOUNT-1-XX-CPN6774 will be required in order to maintain proper RF performance. For availability, please contact your local Lutron sales office.

Environment

- Ambient operating temperature: 32 °F to 140 °F (0 °C to 60 °C)
- Maximum 90% non-condensing relative humidity
- Indoor use only

Warranty

- Limited Warranty: www.lutron.com/warranty or call 1.844.LUTRON1 for a printed copy.

Job Name: Job Number:	Model Numbers:
--	-----------------------

Dimensions

Measurements shown as: in (mm)

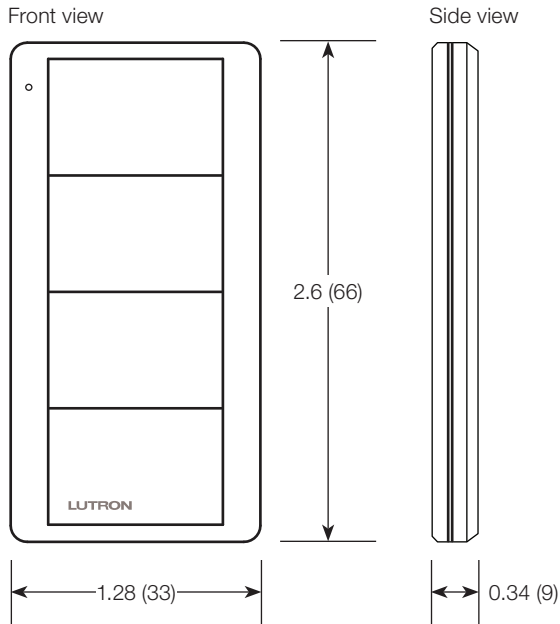

Job Name:	Model Numbers:
Job Number:	

Operation

Indicator LED
Flashes to indicate a button press or when unit is in programming mode.

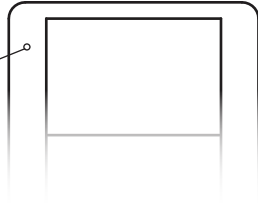

Zone Controls

Lights Models: L01, EL1

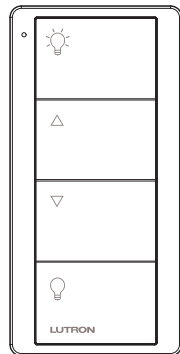

- ON Button**
Lights brighten to full intensity.
- Raise Button**
Lights increase in intensity.
- Lower Button**
Lights decrease in intensity.
- OFF Button**
Lights dim to off.

Shades Models: S01, ES1

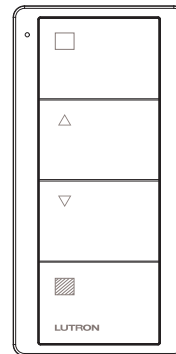

- OPEN Button**
Shades open fully.
- Raise Button**
Shades open gradually.
- Lower Button**
Shades close gradually.
- CLOSE Button**
Shades close fully.

Shade Compatibility of Zone Controls (-S01, -ES1)

System Type	Serena Wireless	Triathlon Wireless	Sivoia QS Wireless	Sivoia QS Wired
Athena	—	—	—	Yes ³
Caséta Smart Bridge	Yes	—	—	—
Caséta Smart Bridge Pro	Yes	Yes	Yes	—
HomeWorks QS	—	Yes ¹	Yes ¹	Yes ¹
HomeWorks QSX	—	Yes ⁴	Yes ⁴	Yes ⁴
myRoom prime	Yes	Yes	Yes	Yes ²
myRoom plus	—	Yes ¹	Yes ¹	Yes ¹
myRoom XC	—	—	—	Yes ²
Quantum systems	—	—	—	Yes ²
RadioRA 2	—	Yes	Yes	—
RA2 Select	—	Yes	Yes	—
RadioRA 3	—	Yes	Yes	—
Standalone Pico	Yes	Yes	Yes	Yes ¹
Vive	Please refer to Lutron Application Note #740 (P/N 048740) at www.lutron.com			

¹ Either a QS sensor module or a hybrid repeater is required.
² QS sensor module required.
³ Either a QS sensor module or an Athena wireless processor is required.
⁴ A QS sensor module, a hybrid repeater, or a HomeWorks wireless processor is required.

(continued on next page...)

Job Name:	Model Numbers:
Job Number:	

Operation (continued)

Scene Controls (Default settings: 100%, 66%, 33%, 0)

Lights Models: L31, EL2

Shades Models: S31, ES2

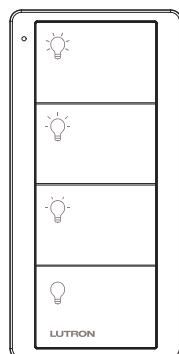

3 Scene Buttons
Tap once: Sends device to preset levels.
Press and hold for 6 seconds: Saves new preset level or position.

OFF Button
Lights dim to off.

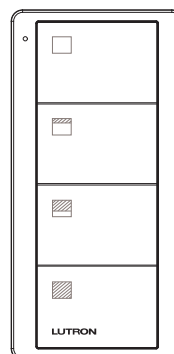

OPEN Button
Shades open fully.

2 Scene Buttons
Tap once: Sends device to preset levels.
Press and hold for 6 seconds: Saves new preset level or position.

CLOSE Button
Shades close fully.

Note: For EL2/ES2 in RA2 Select and Caséta systems, all buttons can be individually programmed to any devices and any levels using the Lutron App.

Shade Compatibility of Scene Controls (-S31, -ES2)

System Type	Serena Wireless	Triathlon Wireless	Sivoia QS Wireless	Sivoia QS Wired
Athena	—	—	—	Yes ³
Caséta Smart Bridge	Yes	—	—	—
Caséta Smart Bridge Pro	Yes	Yes	Yes	—
HomeWorks QS	—	Yes ¹	Yes ¹	Yes ¹
HomeWorks QSX	—	Yes ⁴	Yes ⁴	Yes ⁴
myRoom prime	—	—	Yes	Yes ²
myRoom plus	—	Yes ¹	Yes ¹	Yes ¹
myRoom XC	—	—	—	Yes ²
Quantum systems	—	—	—	Yes ²
RadioRA 2	—	Yes	Yes	—
RA2 Select	—	Yes	Yes	—
RadioRA 3	—	Yes	Yes	—
Standalone Pico	—	—	Yes	—
Vive	Please refer to Lutron Application Note #740 (P/N 048740) at www.lutron.com			

- ¹ Either a QS sensor module or a hybrid repeater is required.
- ² QS sensor module required.
- ³ Either a QS sensor module or an Athena wireless processor is required.
- ⁴ A QS sensor module, a hybrid repeater, or a HomeWorks wireless processor is required.

(continued on next page...)

Job Name:	Model Numbers:
Job Number:	

Operation (continued)

2-Group Controls

Lights Model: L21

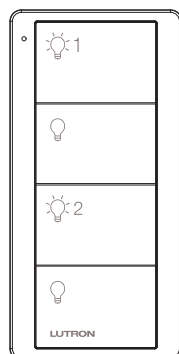

- ON Button #1**
Lights brighten to full intensity.
- OFF Button #1**
Lights dim to off.
- ON Button #2**
Lights brighten to full intensity.
- OFF Button #2**
Lights dim to off.

Shades Model: S21

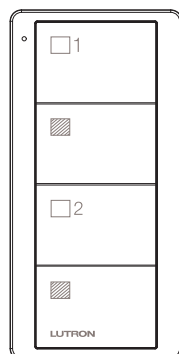

- OPEN Button #1**
Shades open fully.
- CLOSE Button #1**
Shades close fully.
- OPEN Button #2**
Shades open fully.
- CLOSE Button #2**
Shades close fully.

Lights/Shades Model: LS21

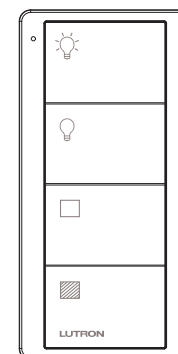

- ON Button**
Lights brighten to full intensity.
- OFF Button**
Lights dim to off.
- OPEN Button**
Shades open fully.
- CLOSE Button**
Shades close fully.

Shade Compatibility of 2-Group Controls (-S21, -LS21)

System Type	Serena Wireless	Triathlon Wireless	Sivoia QS Wireless	Sivoia QS Wired
Athena	—	—	—	Yes ³
Caséta Smart Bridge	Yes	—	—	—
Caséta Smart Bridge Pro	Yes	Yes	Yes	—
HomeWorks QS	—	Yes ¹	Yes ¹	Yes ¹
HomeWorks QSX	—	Yes ⁴	Yes ⁴	Yes ⁴
myRoom prime	—	—	Yes	Yes ²
myRoom plus	—	Yes ¹	Yes ¹	Yes ¹
myRoom XC	—	—	—	Yes ²
Quantum systems	—	—	—	Yes ²
RadioRA 2	—	Yes	Yes	—
RA2 Select	—	Yes	Yes	—
RadioRA 3	—	Yes	Yes	—
Standalone Pico	—	—	Yes	—
Vive	Please refer to Lutron Application Note #740 (P/N 048740) at www.lutron.com			

¹ Either a QS sensor module or a hybrid repeater is required.
² QS sensor module required.
³ Either a QS sensor module or an Athena wireless processor is required.
⁴ A QS sensor module, a hybrid repeater, or a HomeWorks wireless processor is required.

(continued on next page...)

Job Name:	Model Numbers:
Job Number:	

Operation (continued)

4-Group Toggle

Model: L41

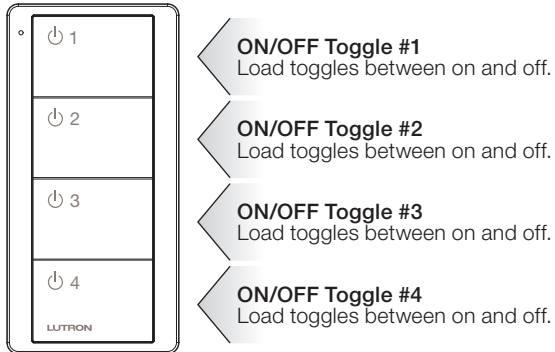

Shade Compatibility of 4-Group Toggle Controls (-L41)

System Type	Serena Wireless	Triathlon Wireless	Sivoia QS Wireless	Sivoia QS Wired
Athena	—	—	—	Yes ³
Caséta Smart Bridge	—	—	—	—
Caséta Smart Bridge Pro	—	—	—	—
HomeWorks QS	—	Yes ¹	Yes ¹	Yes ¹
HomeWorks QSX	—	Yes ⁴	Yes ⁴	Yes ⁴
myRoom prime	—	—	—	—
myRoom plus	—	Yes ¹	Yes ¹	Yes ¹
myRoom XC	—	—	—	Yes ²
Quantum systems	—	—	—	Yes ²
RadioRA 2	—	—	—	—
RA2 Select	—	—	—	—
RadioRA 3	—	—	—	—
Standalone Pico	—	—	—	—
Vive	Please refer to Lutron Application Note #740 (P/N 048740) at www.lutron.com			

¹ Either a QS sensor module or a hybrid repeater is required.

² QS sensor module required.

³ Either a QS sensor module or an Athena wireless processor is required.

⁴ A QS sensor module, a hybrid repeater, or a HomeWorks wireless processor is required.

Job Name:	Model Numbers:
Job Number:	

Model Number

For order quantities of 96 pieces or greater of the same model number, bulk packaging may be available. Mounting hardware is not included with bulk packaging. For availability, please contact Lutron Customer Service at 1.844.LUTRON1 (1.844.588.7661).

Standard Icon Models

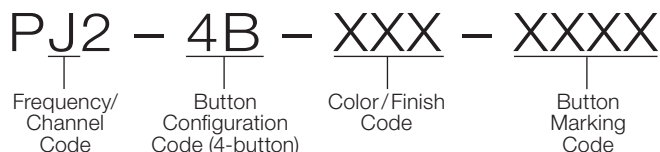

Frequency/Channel Code

J: 431.0–437.0 MHz

Color/Finish Codes

Color	Finish	
	Gloss	Texture (Satin Colors)
White	GWH	TSW
Black	GBL	TMN
Ivory	GIV	–
Light Almond	GLA	–
Biscuit	–	TBI

Button Marking Codes

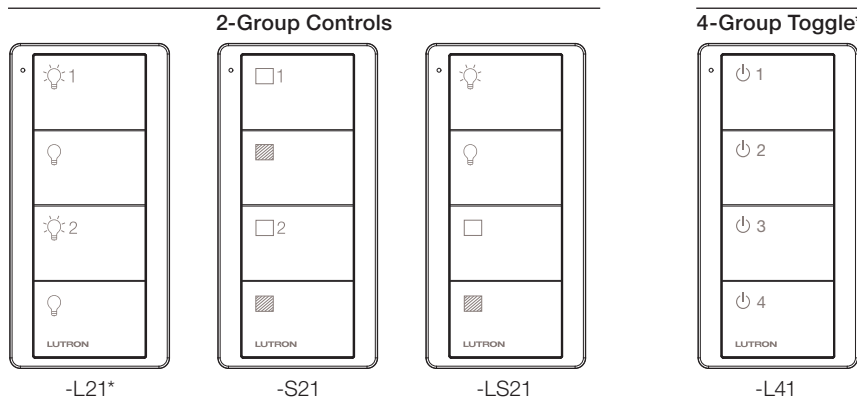
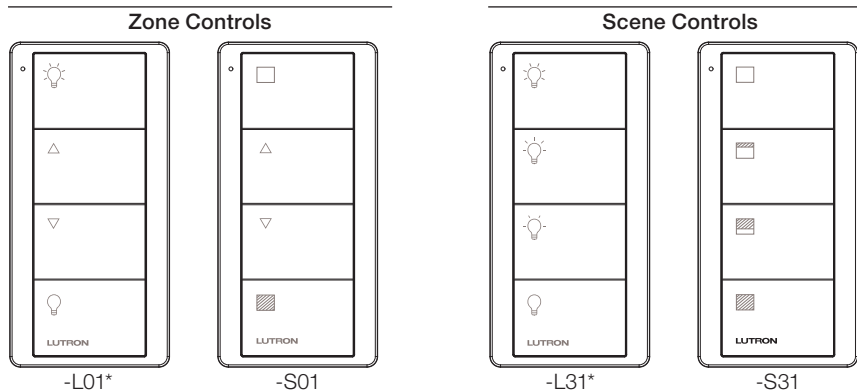

* Add "P" after the Button Marking Code in the model number for Caséta wireless PRO packaging. Available in Gloss White (WH), Black (BL), Ivory (IV), or Light Almond (LA).
 ** HomeWorks, HomeWorks QS, myRoom, myRoom XC, Quantum, and Athena systems only.

(continued on next page...)

<p>LUTRON SPECIFICATION SUBMITTAL</p> <p>Job Name:</p> <p>Job Number:</p>	<p style="text-align: right;">Page</p> <p>Model Numbers:</p>
--	--

Model Number (continued)

Customizable Engraving Models

The Pico 4-Button wireless remote offers customizable engraving on Zone and Scene controls for both lights and shades. The following text restrictions and button marking codes must be considered when ordering from Lutron Customer Service:

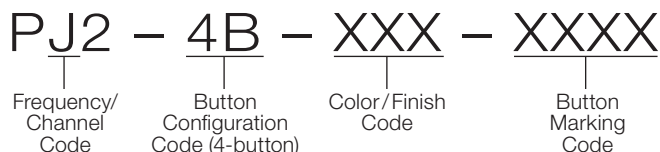

Frequency/Channel Code

J: 431.0–437.0 MHz

Color/Finish Codes

Color	Finish	
	Gloss	Texture (Satin Colors)
White	GWH	TSW
Black	GBL	TMN
Ivory	GIV	–
Light Almond	GLA	–
Biscuit	–	TBI

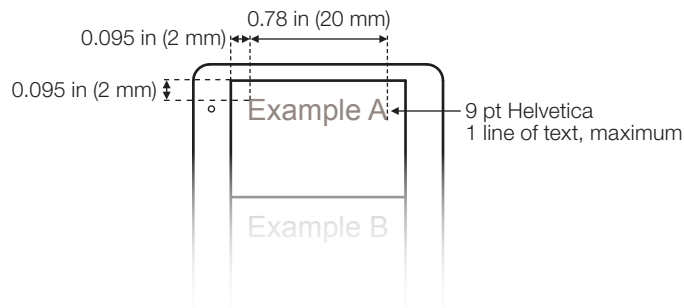

Button Marking Codes

Custom-engraved models for Zone control keypads (-L01, -S01) and Scene control keypads (-L31, -S31) are available but require a different set of button marking codes when ordering (**Note:** 2-Group [-L21, -S21, -LS21] and 4-Group Toggle [-L41] controls are not offered with the custom engraving option).

	Button Marking Codes	
	Standard Engraving	Custom Engraving
Zone Control of Lights	-L01	-EL1
Zone Control of Shades	-S01	-ES1
Scene Control of Lights	-L31	-EL2
Scene Control of Shades	-S31	-ES2

When selecting alternate labels for buttons, remember button functionality presets as shown in the **Operation** section on pages 4 through 7. The examples to the right show sample text choices:

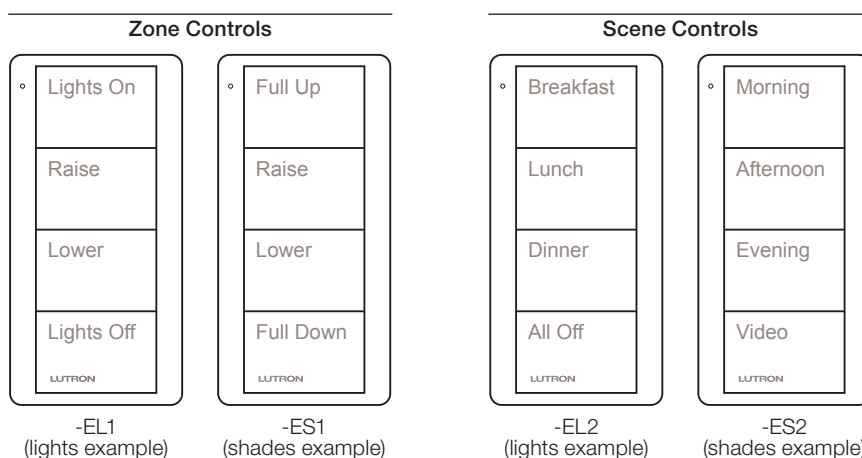

Job Name:	Model Numbers:
Job Number:	

Pico Pedestal Model Number

Pedestals sold separately.



Capacity Codes

Capacity	Code
Single	1
Double	2
Triple	3

Color Codes

Available in gloss finish only.

Color	Code
White	WH
Black	BL

Dimensions

Measurements shown as: in (mm)

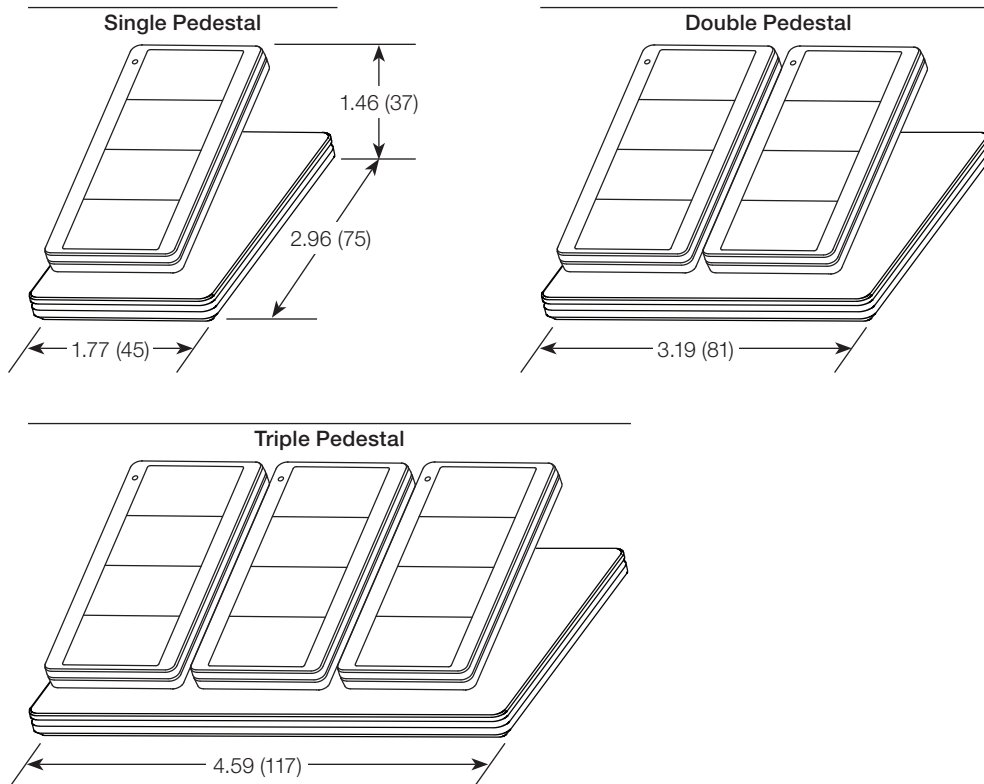

Job Name:	Model Numbers:
Job Number:	

Mounting Options

Standalone Mounting: Adhesive-Mount

Included with Pico wireless remote

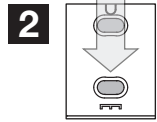
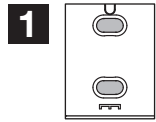

Standalone Mounting: Screw-Mount

Model PICO-SM-KIT
(sold separately)

Kit includes special screws to be used for more permanent mounting and/or for non-smooth surfaces.

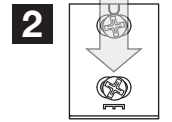
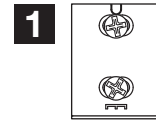

Wallbox Adapter

Model PICO-WBX-ADAPT
(sold separately)

Wallplate adapter/wallplate sold separately.

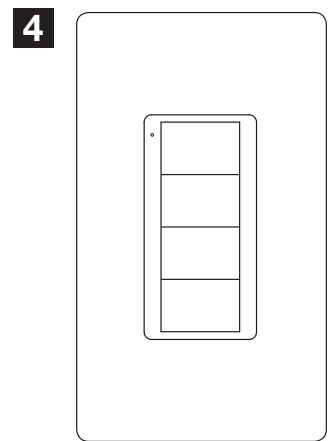
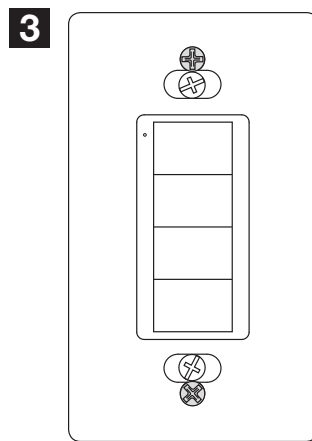
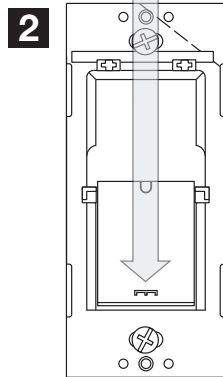
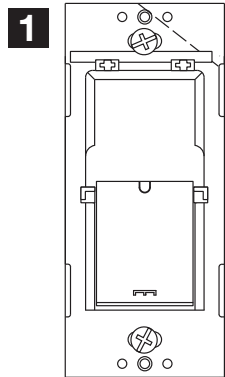

Job Name:	Model Numbers:
Job Number:	

Mounting Options (continued)

Metal Surface Mounting

Model:
PICO-MOUNT-1-XX-CPN6774
(sold separately)

Contact your local Lutron sales office.

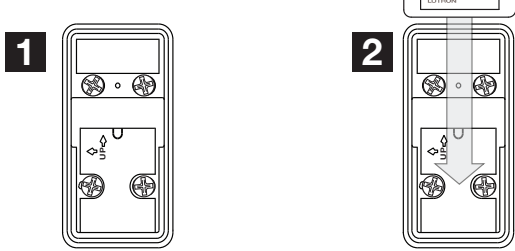

Mounting to a Car Visor

Model PICO-CARVISOR-CL (sold separately)

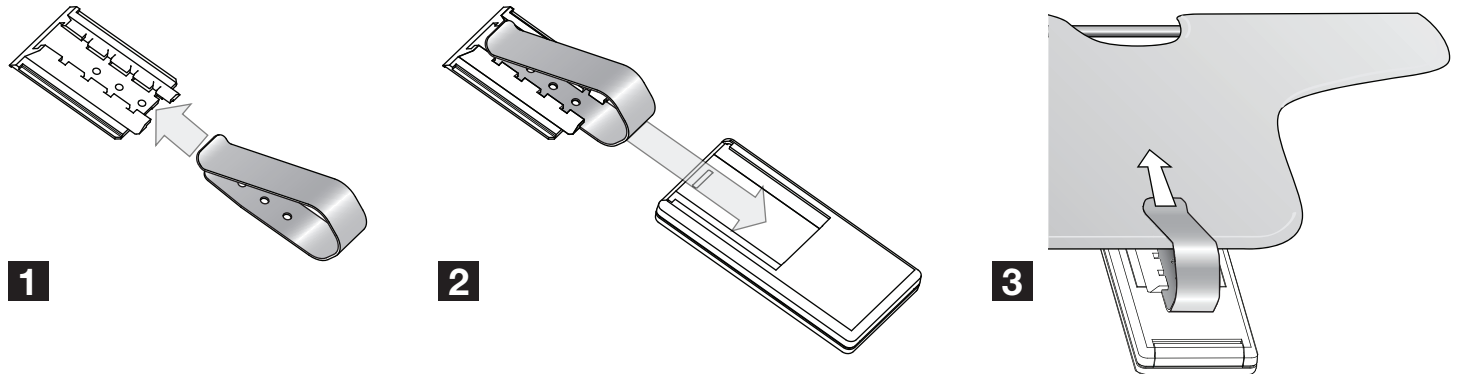

Lutron, the Lutron logo, Athena, Caseta, Clear Connect, EcoSystem, Energi Savr Node, GRAFIK Eye, HomeWorks, Maestro Wireless, myRoom, Pico, PowPak, Quantum, RadioRA, RadioRA 2, RA2 Select, RadioRA 3, Satin Colors, Serena, Sivoia, Sivoia QS, Triathlon, and Vive are trademarks of Lutron Electronics Co., Inc. registered in the U.S. and other countries.

<p>Job Name:</p> <p>Job Number:</p>	<p>Model Numbers:</p>
--	-----------------------