



■ Features :

- Universal AC input / Full range(up to 277VAC)
- Protections:Short circuit/Over current/Over voltage/Over temperature
- Cooling by free air convection
- Built-in constant current limiting circuit with adjustable OCP level
- Fully isolated plastic case
- Built-in active PFC function
- IP64 design for indoor or outdoor installations
- Small and compact size
- Class II power unit, no FG
- 100% full load burn-in test
- High reliability,low cost
- Suitable for Dry / Damp locations
- Suitable for LED lighting and moving sign applications
- 2 years warranty



SPECIFICATION

MODEL	PLN-20-12	PLN-20-18	PLN-20-24	PLN-20-36	PLN-20-48	
OUTPUT	DC VOLTAGE	12V	18V	24V	36V	48V
	CONSTANT CURRENT REGION Note.5	9 ~ 12V	13.5 ~ 18V	18 ~ 24V	27 ~ 36V	36 ~ 48V
	RATED CURRENT	1.6A	1.1A	0.8A	0.55A	0.42A
	CURRENT RANGE	0 ~ 1.6A	0 ~ 1.1A	0 ~ 0.8A	0 ~ 0.55A	0 ~ 0.42A
	CURRENT ADJ. RANGE	75% ~ 100%				
	RATED POWER	19.2W	19.8W	19.2W	19.8W	20.2W
	RIPPLE & NOISE (max.) Note.2	2.5Vp-p	3.0Vp-p	3.0Vp-p	3.0Vp-p	3.8Vp-p
	VOLTAGE TOLERANCE Note.3	±10%				
	LINE REGULATION	±3.0%				
	LOAD REGULATION	±10%				
SETUP TIME	500ms / 230VAC 2000ms / 115VAC at full load					
INPUT	VOLTAGE RANGE Note.4	90 ~ 277VAC 127~392VDC				
	FREQUENCY RANGE	47 ~ 63Hz				
	POWER FACTOR	PF ≥ 0.9 at 75~100% load, 115VAC/230VAC; PF ≥ 0.9 at 85~100% load 277VAC (Please refer to "Power Factor Characteristic" curve)				
	TOTAL HARMONIC DISTORTION	THD< 20% when output loading≥75% at 115VAC/230VAC input and output loading≥75% at 277VAC input				
	EFFICIENCY(Typ.)	80%	81%	82%	83%	83.5%
	AC CURRENT	0.4A/115VAC 0.2A/230VAC 0.15A/277VAC				
	INRUSH CURRENT(Typ.)	COLD START 35A(width=40µs measured at 50% Ipeak) at 230VAC				
	MAX. No. of PSUs on 16A CIRCUIT BREAKER	98 units (circuit breaker of type B) / 98 units (circuit breaker of type C) at 230VAC				
LEAKAGE CURRENT	0.5mA / 240VAC					
PROTECTION	OVER CURRENT Note.5	95 ~ 110% Protection type : Constant current limiting, recovers automatically after fault condition is removed				
	SHORT CIRCUIT	Hiccup mode, recovers automatically after fault condition is removed.				
	OVER VOLTAGE	14 ~ 16V	19 ~ 22V	27 ~ 34V	41 ~ 46V	54 ~ 60V
	OVER TEMPERATURE	Shut down o/p voltage, recovers automatically after temperature goes down				
ENVIRONMENT	WORKING TEMP.	-30 ~ +60°C (Refer to "Derating Curve")				
	WORKING HUMIDITY	20 ~ 90% RH non-condensing				
	STORAGE TEMP., HUMIDITY	-40 ~ +80°C, 10 ~ 95% RH				
	TEMP. COEFFICIENT	±0.06%/°C (0 ~ 50°C)				
	VIBRATION	10 ~ 500Hz, 2G 10min./1cycle, period for 60min. each along X, Y, Z axes				
SAFETY & EMC	SAFETY STANDARDS	IEC61347-1, IEC61347-2-13, TUV EN61347-1, EN61347-2-13, UL8750, CSA C22.2 No. 250.0-08, J61347-1, J61347-2-13, IP64 approved				
	WITHSTAND VOLTAGE	I/P-O/P:3.75KVAC				
	ISOLATION RESISTANCE	I/P-O/P:100M Ohms/500VDC / 25°C/ 70%RH				
	EMC EMISSION	Compliance to EN55015,EN61000-3-2 Class C(≥75% load);EN61000-3-3				
OTHERS	EMC IMMUNITY	Compliance to EN61000-4-2,3,4,5,6,8,11;EN61547, light industry level, criteria A				
	MTBF	643.6Khrs min. MIL-HDBK-217F (25°C)				
NOTE	DIMENSION	148.5*38.5*28mm (L*W*H)				
	PACKING	0.18Kg; 60pcs/12.8Kg/0.9CUFT				

1. All parameters NOT specially mentioned are measured at 230VAC input, rated load and 25°C of ambient temperature.
2. Ripple & noise are measured at 20MHz of bandwidth by using a 12" twisted pair-wire terminated with a 0.1uf & 47uf parallel capacitor.
3. Tolerance : includes set up tolerance, line regulation and load regulation.
4. Derating may be needed under low input voltage, please check the static characteristic for more details.
5. Please refer to "DRIVING METHODS OF LED MODULE".
6. The power supply is considered as a component that will be operated in combination with final equipment. Since EMC performance will be affected by the complete installation, the final equipment manufacturers must re-qualify EMC Directive on the complete installation again.
7. Direct connecting to LEDs is suggested, but is not suitable for using additional drivers.
8. To fulfill requirements of the latest ErP regulation for lighting fixtures, this LED power supply can only be used behind a switch without permanently connected to the mains.

**Mechanical Specification**

Case No.989B Unit:mm

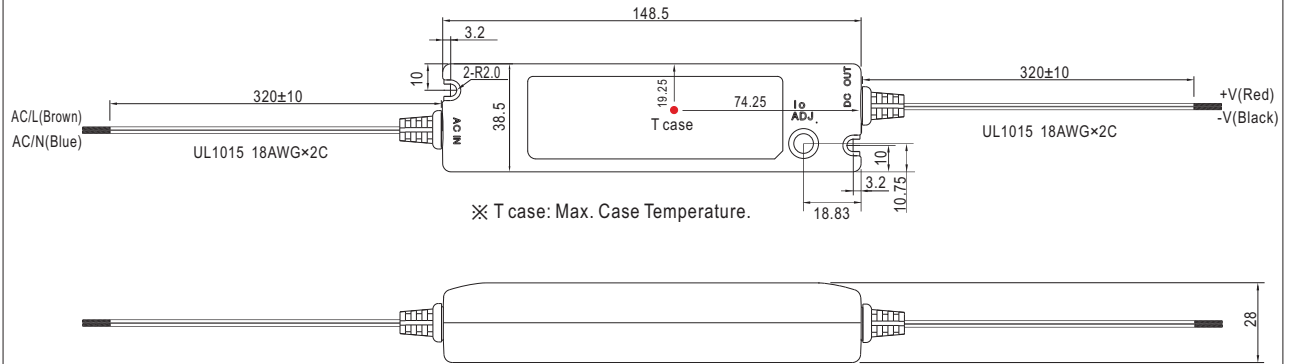

**Block Diagram**

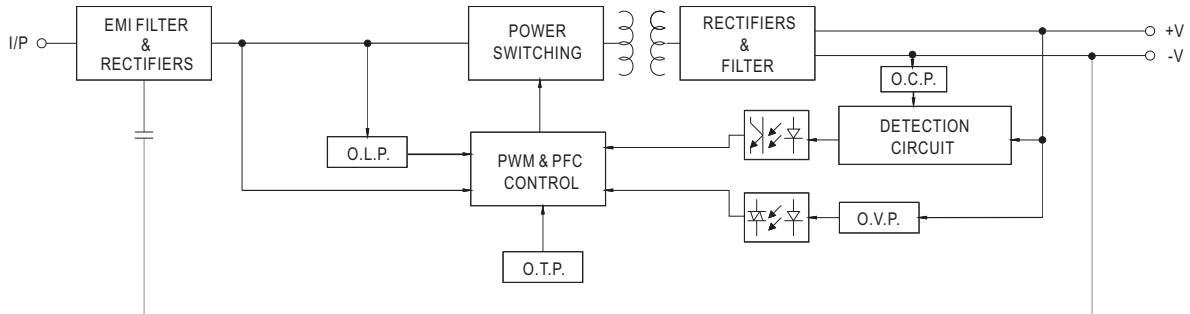

**Derating Curve**

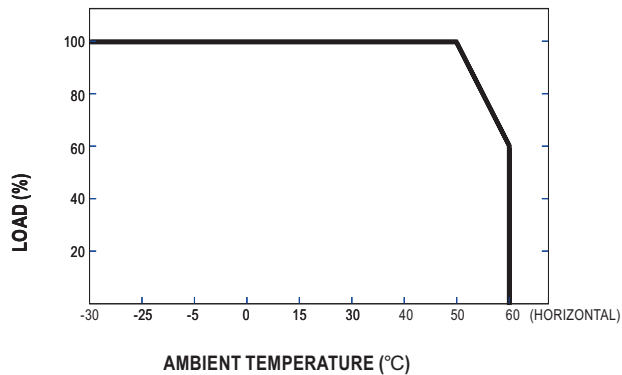

**Static Characteristics**

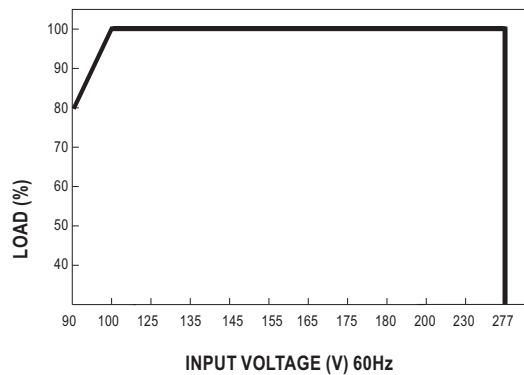

**Power Factor Characteristic**

Power factor will be higher than 0.9 when output loading is 75% or higher.

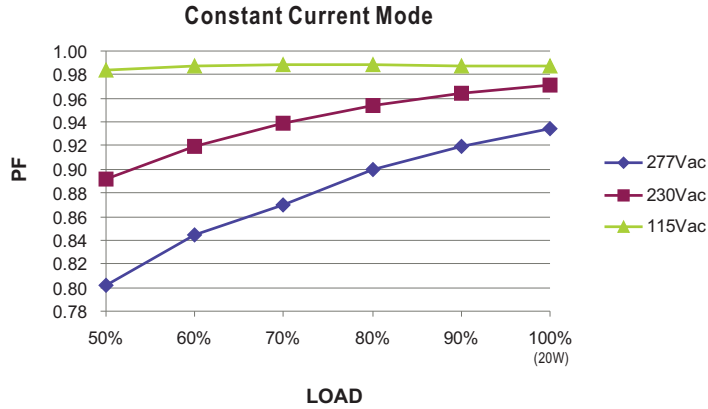

**EFFICIENCY vs LOAD (48V Model)**

PLN-20 series possess superior working efficiency that up to 83.5% can be reached in field applications.

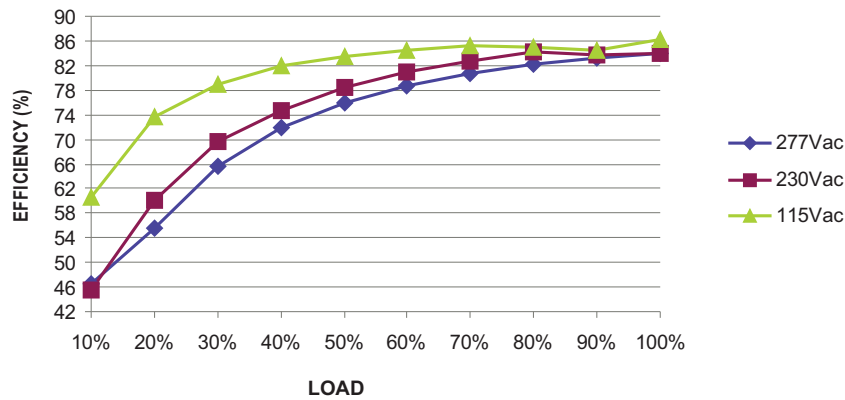

**DRIVING METHODS OF LED MODULE**

This LED power supply is suggested to work in constant current mode area (CC) to drive the LEDs.

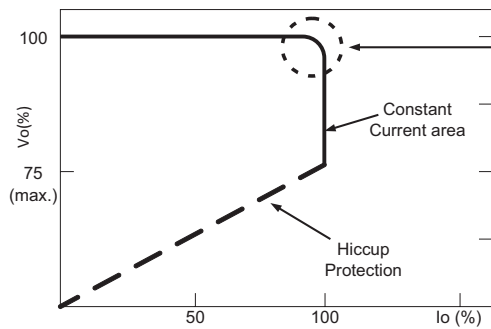

Typical LED power supply I-V curve

In the constant current region, the highest voltage at the output of the driver depends on the configuration of the end systems.  
Should there be any compatibility issues, please contact MEAN WELL.