



SOSEN LED Driver, Your Smart Choice

Specifications

SS-60L Series LED Driver

Model: SS-60L-XX*

Description: 60W LED Driver

Rev.: V01

Release Date: 2019-07-23

SS-60L Series LED Driver

SOSEN
LED DRIVER



LED DRIVER

L Series



Features:

- ❑ Efficiency up to 88%
- ❑ Isolated dimming: 1-10V, PWM, Resistor
- ❑ IP42
- ❑ Protections: SCP/OVP
- ❑ Class P
- ❑ Class 2
- ❑ TYPE HL, suitable for hazardous locations
- ❑ Built-in lightning protection circuit
- ❑ Warranty: 5 years

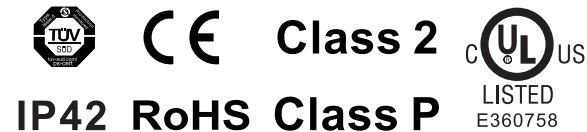

Description:

SS-60L series is a 60W constant current driver with an input voltage range of 108-305Vac and a high power factor. Designed for LED lighting, this series is designed for wall washers, street lights, tunnel lights and area lighting. Adopting a new isolation dimming solution, compact housing design, good heat dissipation, greatly improving the reliability, stability and safety of the product.

Model List:

Model	AC Input Range	Max. Pout	Vout Range	Full Power Vo Range	Iout	THD(Typ.)	PF(Typ.)	Eff.(Typ.)	Max.Tc
SS-60L-42*-XXXX	108-305Vac	60W	24-42V	34-42V	1.45A	10%	0.95	88%	90°C
					1.65A				
SS-60L-54*-XXXX	108-305Vac	60W	36-54V	42-54V	0.86A	10%	0.95	88%	90°C
					1.05A				
					1.25A				

Default tested at 220Vac, full load, Ta 25°C.

1. $P_o = V_o \cdot I_o = 60W$, Full load

2. "*" Optional B or space in the place of * means additional function.

- Space is the base model without any optional function; Surge protection: L/N-PE: 6kV, L-N: 4kV (basic model);

- Suffix B for model with 3-in-1 Isolated dimming (1-10V, PWM, Resistor); Surge protection: L/N-PE: 6kV, L-N: 4kV

- Suffix F for model with no dimming function; Surge protection: L/N-PE: 10kV, L-N: 6kV

- Suffix BF for model with 3-in-1 Isolated dimming (1-10V, PWM, Resistor); Surge protection: L/N-PE: 10kV, L-N: 6kV

3. The XXXX in the model number indicates the optional output current of the model, for example: output 1450mA current, model SS-60L-42-1450.

SS-60L Series LED Driver

Input Characteristics:

Parameter	Min.	Typ.	Max.	Remark
Rated AC Input Range	120Vac		277Vac	
AC Input Range	108Vac		305Vac	
Input Frequency Range	47Hz	50/60Hz	63Hz	
Max Input Current			0.7A	120Vac, Full load
Max Input Power			75W	120Vac, Full load
Max Inrush Current(120Vac)			45A	Cold start
Max Inrush Current(220Vac)			55A	Cold start
Max Inrush Current(277Vac)			80A	Cold start
No Load Power			2W	220Vac/50Hz, No load
Power Factor	0.95	0.98		220Vac/50Hz, Full load
	0.92			120-277Vac/50Hz, 70-100% load
THD		10%	15%	220Vac/50Hz, Full load
			20%	120-277Vac/50Hz, 70-100% load

SS-60L Series LED Driver

Output Characteristics(SS-60L-42*-XXXX):

Parameter	Min.	Typ.	Max.	Remark
Output Voltage Range	24V		42V	
Rated Output Voltage	34V		42V	
Rated Output Current		1.45A		Po=Vo*Io=60W, Full load
		1.65A		
No Load Voltage			50V	
Efficiency @120Vac	86.0%	88.0%		Output 42V/1.45A
Efficiency @220Vac	86.5%	88.5%		Output 42V/1.45A
Efficiency @277Vac	85.5%	87.5%		Output 42V/1.45A
Output Current Tolerance	-7%		+7%	
Output Current Ripple(PK-AV)			50%	
Start-up Current Overshoot			10%	Full load
Start-up Time			0.75S	120Vac
			0.5S	220Vac
Line Regulation	-5%		+5%	Full load
Load Regulation	-5%		+5%	
Temperature Coefficient	-0.05%/°C		+0.05%/°C	Tc:0°C~90°C
Short Circuit Protection			10W	Driver will not be damaged, Hiccup mode

SS-60L Series LED Driver

Output Characteristics(SS-60L-54*-XXXX):

Parameter	Min.	Typ.	Max.	Remark
Output Voltage Range	36V		54V	
Rated Output Voltage	42V		54V	
Rated Output Current		0.86A		Po=Vo*Io=60W, Full load
		1.05A		
		1.25A		
No Load Voltage			60V	
Efficiency @120Vac	86.0%	88.0%		Output 48V/1.25A
Efficiency @220Vac	86.5%	88.5%		Output 48V/1.25A
Efficiency @277Vac	85.5%	87.5%		Output 48V/1.25A
Output Current Tolerance	-7%		+7%	
Output Current Ripple(PK-AV)			50%	
Start-up Current Overshoot			10%	Full load
Start-up Time			0.75S	120Vac
			0.5S	220Vac
Line Regulation	-5%		+5%	Full load
Load Regulation	-5%		+5%	
Temperature Coefficient	-0.05%/°C		+0.05%/°C	Tc:0°C~90°C
Short Circuit Protection			10W	Driver will not be damaged, Hiccup mode

SS-60L Series LED Driver

Other Characteristics:

Parameter	Min.	Typ.	Max.	Remark
0-10V Dimming (Optional)	Dim Vmax	1V		12V
	Dim Range	10%Iomax		100%Ioset
	Rec.Dim Range	1V		10V
PWM Dimming (Optional)	PWM High	9.8V		10.2V
	PWM Low	0V		0.3V
	Frequency	1KHz		2KHz
	PWM Duty	10%		100%
Resistor Dimming (Optional)	Resistance	10Kohm		100Kohm
	Dim Range	10%Iomax		100%Ioset
Lifetime(Tc≤73°C)	≥62,000 hours			80% load
MTBF	262,000 hours			220Vac, Full load, Ta=25°C (MIL-HDBK-217F)
IP Grade	IP42			
Tc	90°C			
Warranty	5 years			Refer to life time drawing
Net Weight	500g			
Dimension	110mm*69.5mm*36.2mm			L x W x H

NOTE: All the parameters above are tested Ta 25°C, unless specified.

SS-60L Series LED Driver

Environmental Requirements

Parameter	Min.	Typ.	Max.	Remark
Operating Temperature(Tcase)	-40°C	25°C	+90°C	
Storage Temperature	-40°C	25°C	+85°C	
Operation Humidity	10%RH		90%RH	
Storage Humidity	5%RH		95%RH	
Altitude	-65m		4000m	

Safety and EMI/EMS Standards

Certification	Standard	Status	Remark
UL/cUL	UL8750	✓	
TUV	EN 61347-2-13:2014 EN61347-1:2008+A1:2011+A2:2013 EN62493:2015	✓	
RCM	AS/NZS61347.2.13		
CCC	GB 19510.14-2009		
CE	EN 61347-2-13:2014 EN61347-1:2008+A1:2011+A2:2013	✓	

EMI/EMS	Criterion	Remark
Conduction Emission	EN55015:2013+A1:2015	
Radiation Emission	EN55015:2013+A1:2015	
Harmonic Current Emissions	IEC/EN 61000-3-2	Class C
Surge	IEC/EN61000-4-5	Difference mode 4kV, Common mode 6kV,Criterion B

SS-60L Series LED Driver

Safety Test Items:

Safety test items	Technical Indicators			Remark
Insulation Requirements	UL Insulation Requirements	TUV Insulation Requirements	CCC Insulation Requirements	
Input-Output	1600Vac	3000Vac	3750Vac	Reinforced insulation
Input-Case	1600Vac	1500Vac	1875Vac	Basic insulation
Input-Dim	1600Vac	3000Vac	3750Vac	Reinforced insulation
Input-Dim	1600Vac	1000Vac	1000Vac	Additional insulation
Output-Case	500Vac	1000Vac	1000Vac	Function insulation
Dim-Case	500Vac	250Vac	250Vac	
Insulation Resistance	≥10MΩ			Input-Output, Test voltage:500Vdc
Ground Resistance	≤0.1Ω			25A/1min
Leak Current	≤0.75mA			277Vac

NOTE:

1. SOSEN warrants the LED Driver itself meets with EMC standard. However, LED Driver's EMC should be re-checked when integrated into lighting systems due to unexpected interference as component.
2. Please short Line and Neutral, LED+ and LED-, Dim+ and Dim - when Hi-pot test.
3. The CCC withstand voltage test needs to disconnect the built-in lightning protection tube. According to the IEC 60598-1:14 standard section 10.2, the "built-in lightning protection tube" can be marked on the nameplate to disconnect the discharge tube on testing.

Performance Curves:

Input Inrush Current

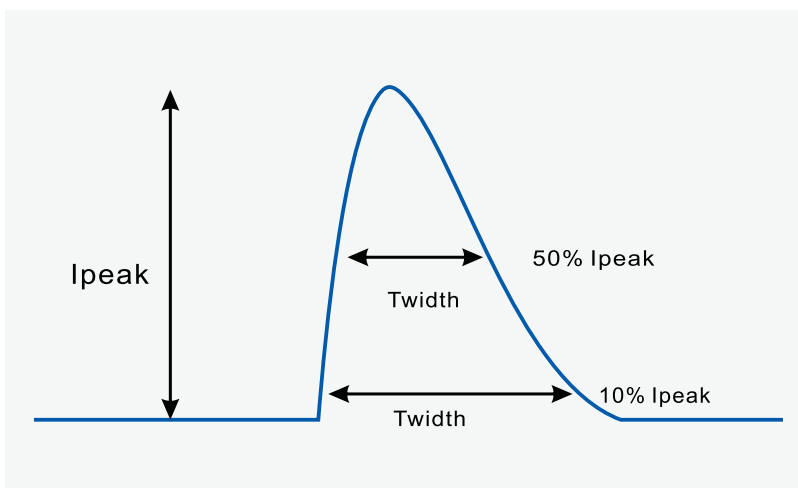

Vin	Ipeak	T(@10% of Ipeak)	T(@50% of Ipeak)
120Vac	45A		200uS
220Vac	55A		200uS
277Vac	80A	500uS	

SS-60L Series LED Driver

Performance Curves:

Output Voltage Vs. Output Current(Dim Window)

SS-60L-42*-XXXX

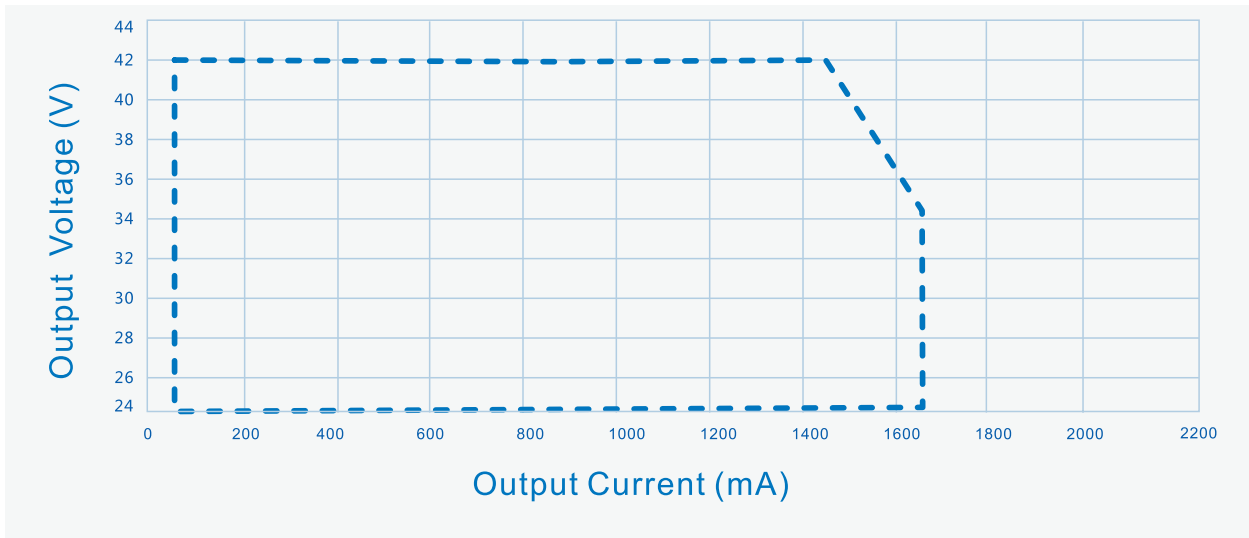

----- Dimming Window

Output Voltage Vs. Output Current(Dim Window)

SS-60L-54*-XXXX

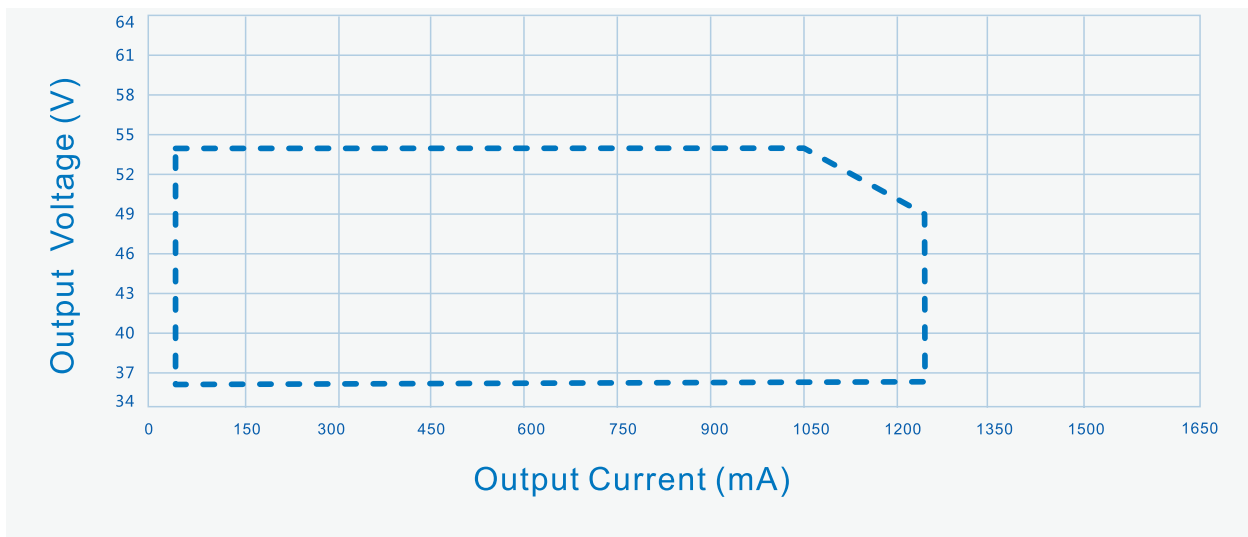

----- Dimming Window

SS-60L Series LED Driver

Performance Curves:

Efficiency Vs. Output Voltage ($V_{in}=120Vac$)

SS-60L-42*-XXXX

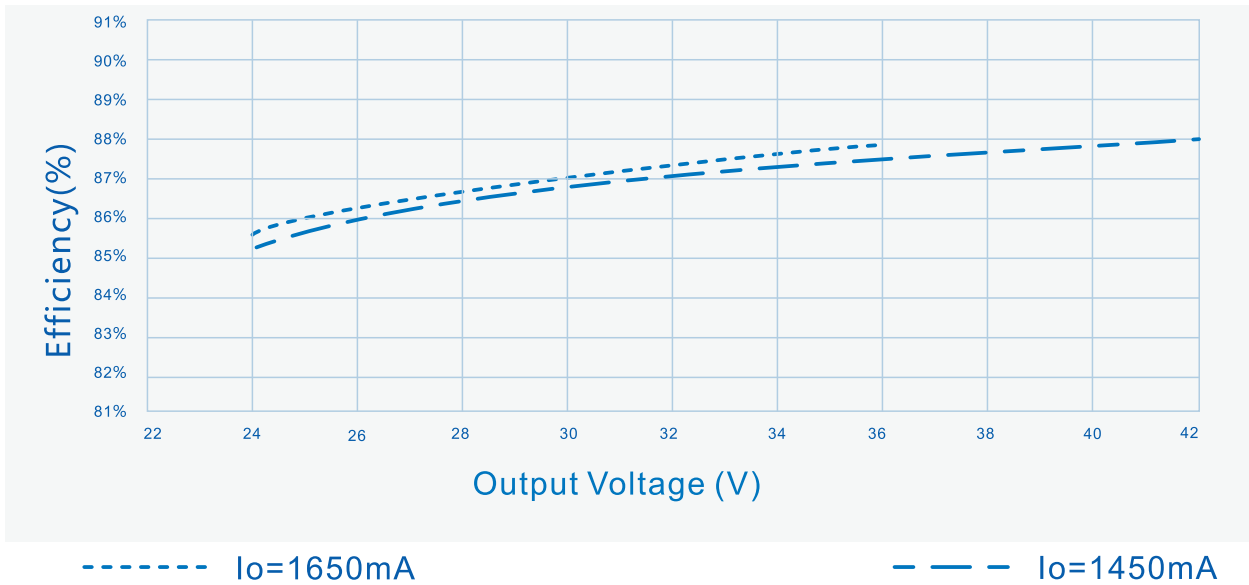

Efficiency Vs. Output Voltage ($V_{in}=220Vac$)

SS-60L-42*-XXXX

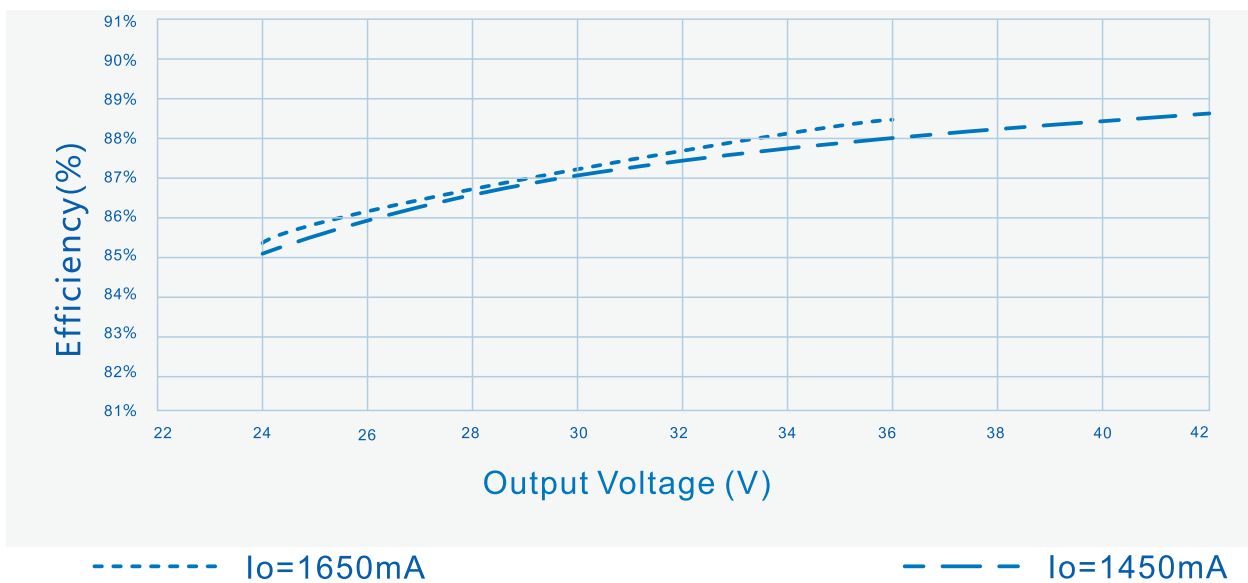

SS-60L Series LED Driver

Performance Curves:

Efficiency Vs. Output Voltage ($V_{in}=277V_{ac}$)

SS-60L-42*-XXXX

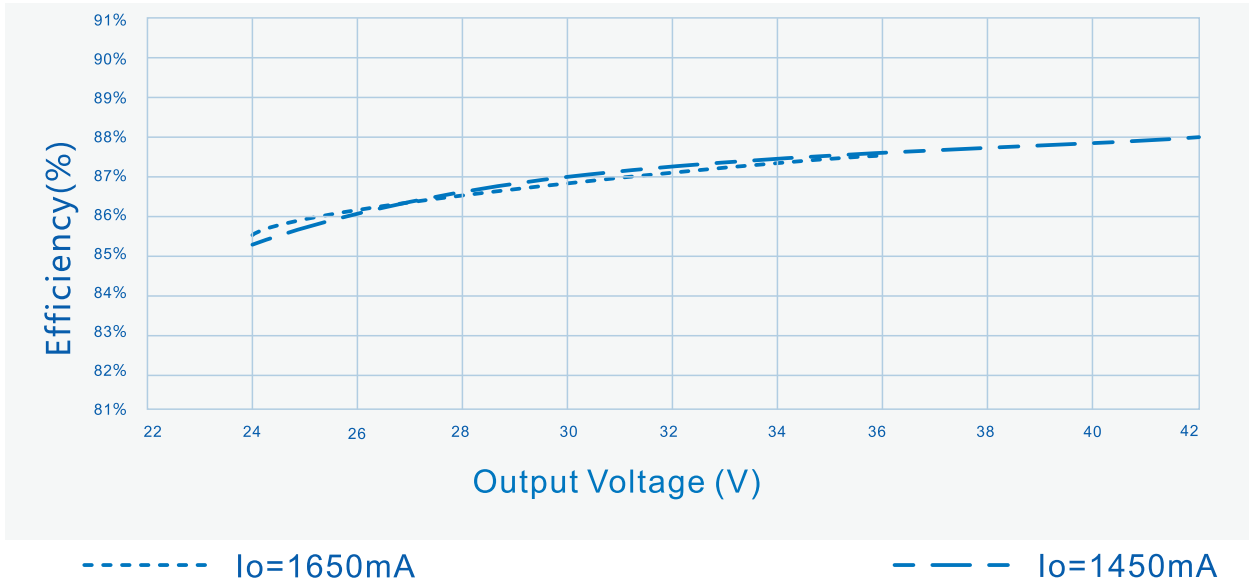

Efficiency Vs. Output Voltage ($V_{in}=120V_{ac}$)

SS-60L-54*-XXXX

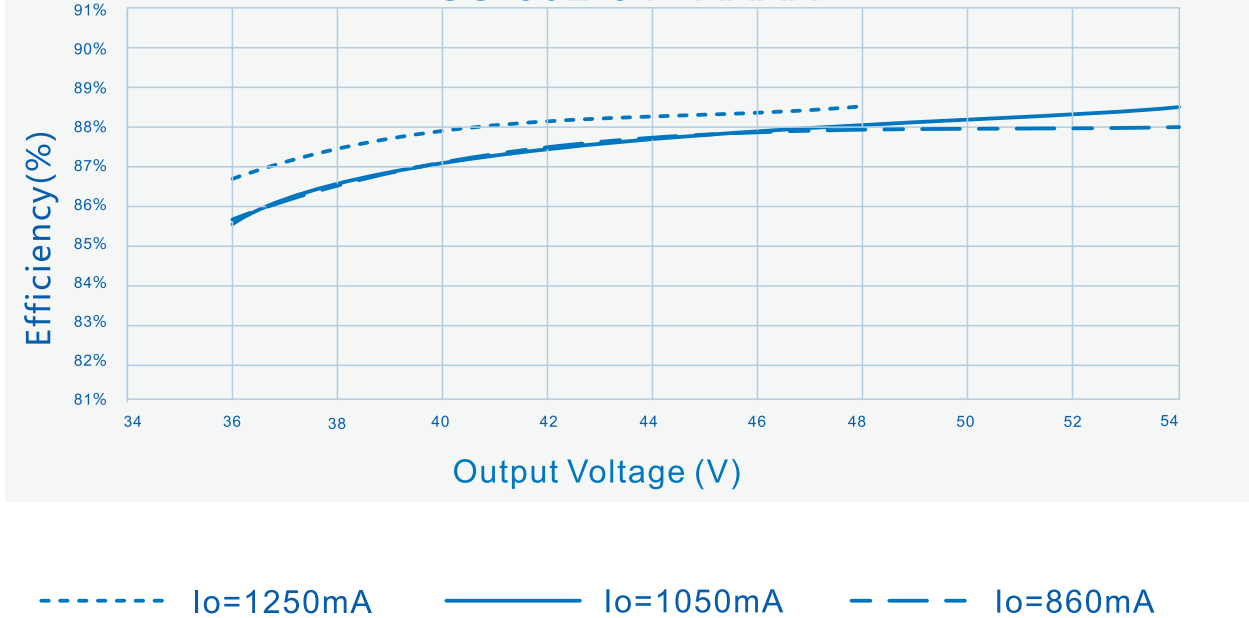

SS-60L Series LED Driver

Performance Curves:

Efficiency Vs. Output Voltage ($V_{in}=220V_{ac}$)

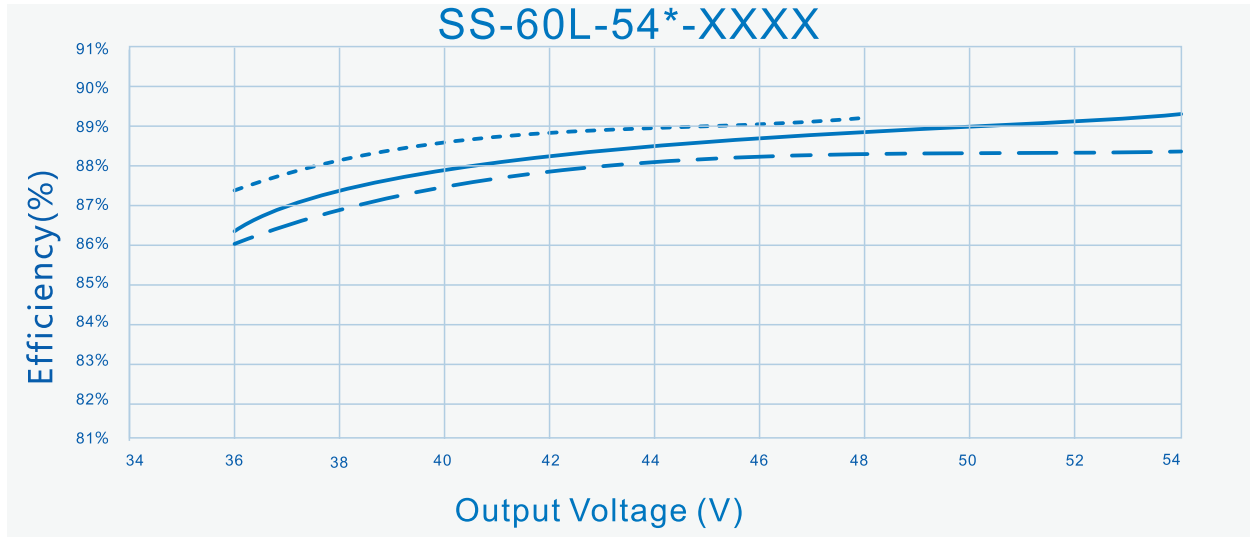

----- $I_o=1250mA$ ———— $I_o=1050mA$ - - - - $I_o=860mA$

Efficiency Vs. Output Voltage ($V_{in}=277V_{ac}$)

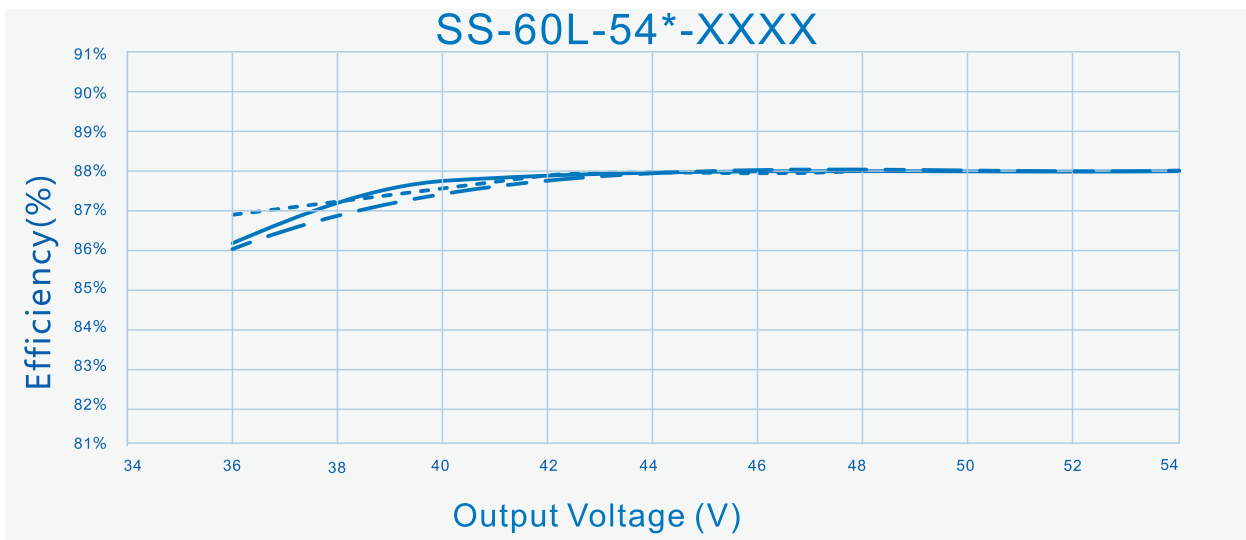

----- $I_o=1250mA$ ———— $I_o=1050mA$ - - - - $I_o=860mA$

SS-60L Series LED Driver

Performance Curves:

Power Factor Vs. Output Power

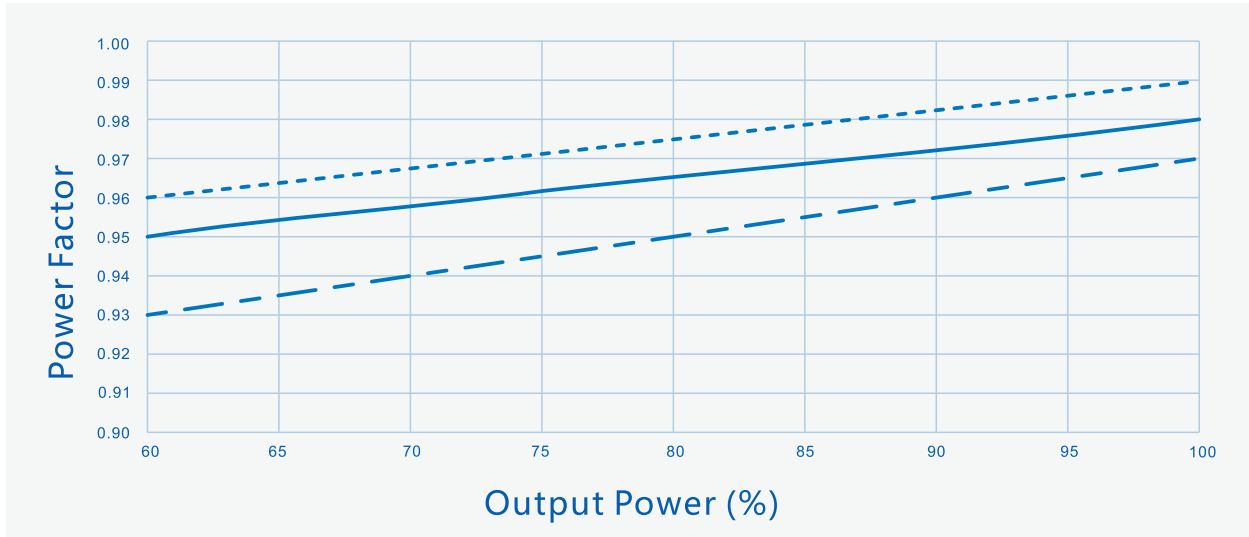

----- Vin=120Vac ——— Vin=220Vac - · - · Vin=277Vac

THD Vs. Output Power

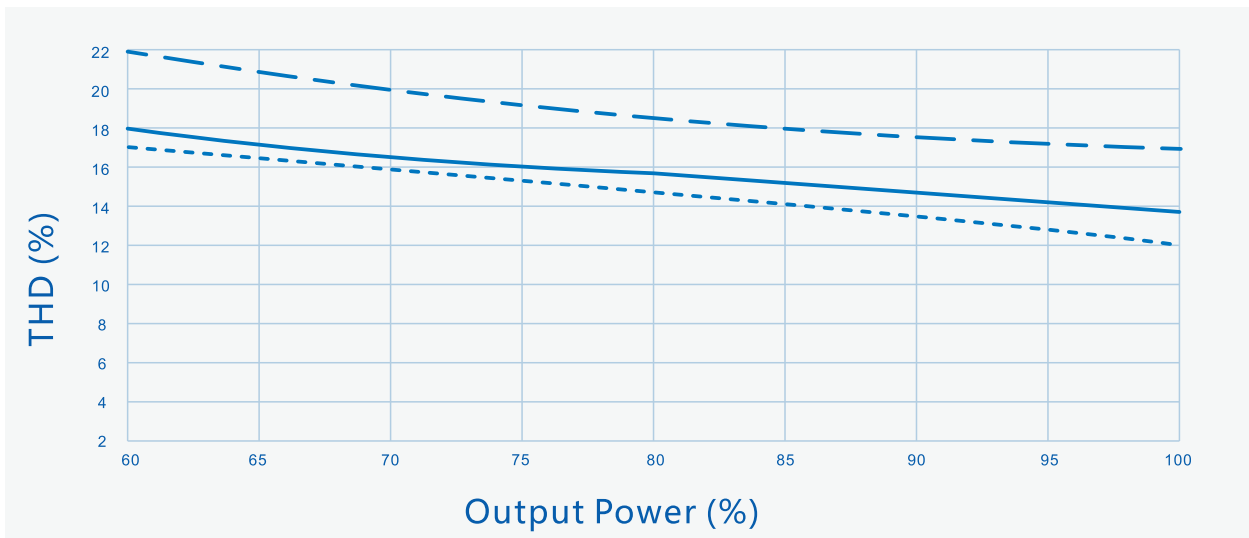

----- Vin=120Vac ——— Vin=220Vac - · - · Vin=277Vac

SS-60L Series LED Driver

Performance Curves:

Output power Vs. Input Voltage
(Ta Max.55°C)

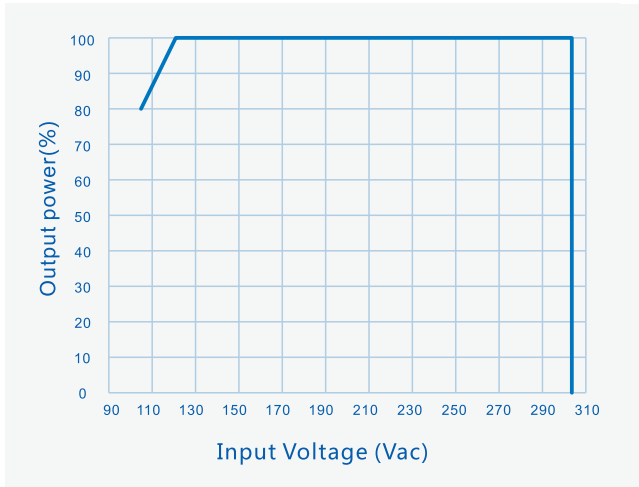

Output power Vs. Case Temperature

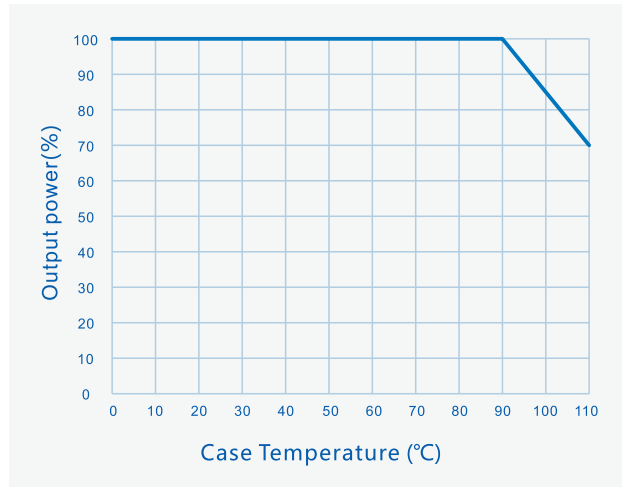

Output Power Vs. Dimming

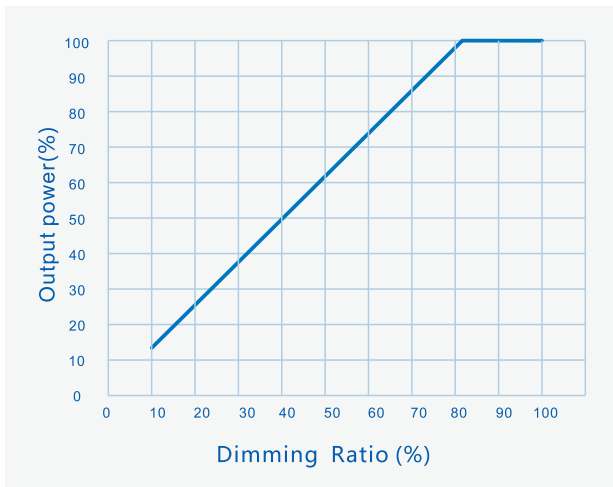

Lifetime Vs. Case Temperature

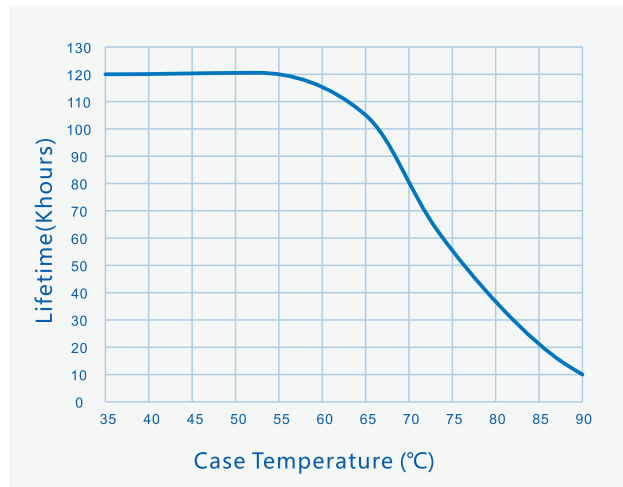

SS-60L Series LED Driver

Mechanical characteristics(Unit: mm)

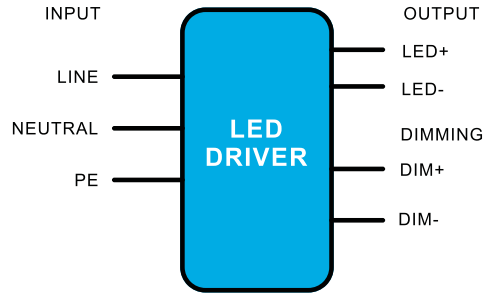

AC Input Cable(Lead Length outside enclosure 350±10mm):

UL model: 18AWG 105°C 600V,I.D: 1.0mm,O.D: 2.2mm,Electronic line, Black:L, White:N,Green:PE

DC Output Cable(Lead Length outside enclosure 200±10mm):

UL model: 18AWG 105°C 600V,I.D: 1.0mm,O.D: 2.2mm,Electronic line, Red:LED+, Black:LED-

DIM Cable(Lead Length outside enclosure 150±10mm):

UL model: 18AWG 105°C 600V,I.D: 1.0mm,O.D: 2.2mm,Electronic line, Purple : DIM+, Gray: DIM-

Name Description	Standard Code	mm(In.)
Case Length	L3	91(3.58)
Case Width	W1	69.5(2.7)
Case Height	H	36.2(1.4)
Overall Length	L1	110(4.33)
Mounting Hole Length	L2	99.5(3.92)
Mounting Hole Width	W2	60(2.36)
TC point position	X	32.6(1.28)
TC point position	Y	25.6(1.01)

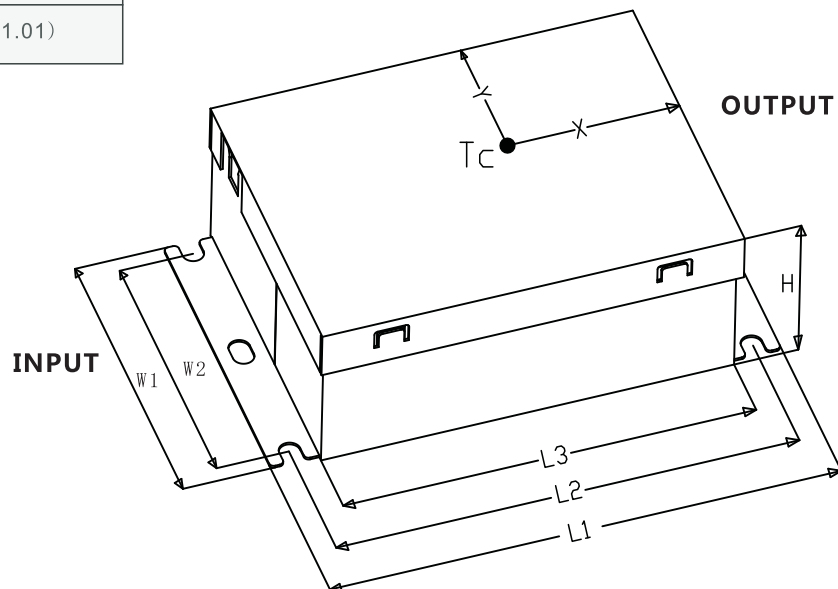

SS-60L Series LED Driver



Installation Tips

1. Highly recommended to seal the adjustable hole with silicon glue(#704 preferred) after adjusting the driver's output current. Torsion with proper strength to avoid permanent damage to the potentiometer inside.
2. Dimming leads should be capped if not in use to avoid dimming circuit damage caused by external signals.

Package

- Outside carton dimension: L×W×H =495mm×385mm×162mm;
- 36PCS/Carton;
- Net weight/PC: 0.5kg;Gross weight/Carton: 19kg;
- Please refer to the product name, model number, manufacturer identification, quality inspection certificate, manufacturing date Etc. on the package. and LED power supply instruction manual in the package.

Transportation

Packaging is designed suitable for transportation by trucks, vessels and flights. The products should be shielded from direct sunshine, loaded/unloaded with caution.

Storage

The product storage meets the standard of the GB 3873 - 83.
Products should be rechecked if stock for over 1 year before installation.

RoHS

Products comply with European directive 2011/65/EC.

REVISION HISTORY

Version	Description of Change	Changed Date	Remark
V00	Original release	2019/03/01	
V01	Increase TUV certification	2019/07/23	

