

DATE

PROJECT

TYPE

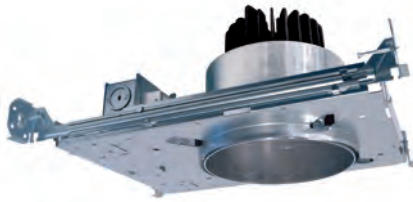



R6NC SERIES | 6-Inch Round Universal New Construction Housing

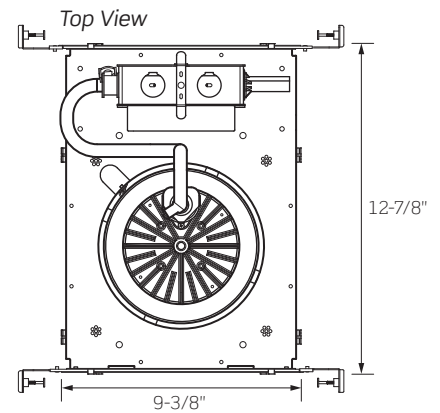
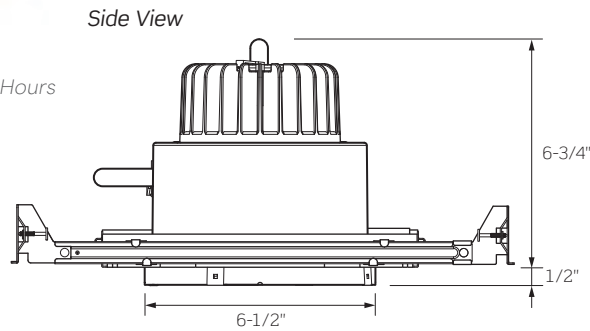

SPEEDSHIP
Select SKUs Shipped within 48-Hours



Ceiling Opening: 6-5/8"
Ceiling Thickness: 1/2" - 2"

| | R6NC1 | R6NC2 | R6NC3 | R6NC4 | R6NC5 | R6NC6 |
|----------------------------------|--|-------------|-------------|-------------|-------------|-------------|
| WATTAGE | 12W | 16W | 21W | 30W | 38W | 45W |
| LUMEN OUTPUT ¹ | 1100Lm | 1600Lm | 2200Lm | 3000Lm | 3700Lm | 4100Lm |
| COLOR TEMPERATURE | 2700K / 3000K / 3500K / 4000K | | | | | |
| CRI | 83 (80min) / 90+ | | | | | |
| INPUT WATTAGE | 12W | 16W | 21W | 30W | 38W | 45W |
| INPUT CURRENT (A) 120V/277V/347V | .08/.04/.03 | .12/.06/.04 | .17/.08/.06 | .23/.11/.08 | .31/.14/.11 | .36/.16/.12 |
| INPUT VOLTAGE Standard Driver | 120VAC / 277VAC / 347VAC, 50/60Hz | | | | | |
| Lutron Eco-System® Driver | 120VAC / 277VAC, 50/60Hz | | | | N/A | N/A |
| eldoLED ECOdrive and SOLOdrive | 120VAC / 277VAC, 50/60Hz | | | | | |
| DRIVER POWER FACTOR | > 0.90 | | | | | |
| TOTAL HARMONIC DISTORTION (THD) | < 20% | | | | | |
| LISTINGS |     <p>cCSAus Certified to UL Standards; Suitable for Damp Locations cCSAus Certified to UL924 Standard for Emergency Lighting when specified with the Emergency Battery Backup option ENERGY STAR® Certified: – All Wattage/Lumen options are ENERGY STAR® Certified – ENERGY STAR® Certified Trims: C6322-PL, CN6322-PL, C6322-WHT, CN6322-WHT, C6322-CLR and CN6322-CLR (all beam distributions); –C (Clear Lens) and –SL (Sandblasted Lens) trim options are not ENERGY STAR® Certified – 347V Option, Lutron and eldoLED Dimming Options are not ENERGY STAR® Certified</p> | | | | | |
| WARRANTY | Five (5) year replacement after date of purchase Emergency Battery Backup option covered by a one (1) year replacement guarantee after date of purchase | | | | | |
| SYSTEM RATING | 50,000 Hours @ 70% Lumen Maintenance | | | | | |

1. Approximate lumen output based on 3000K performance; see photometric test results for additional information

| DATE | PROJECT | TYPE |
|------|---------|------|
|------|---------|------|

R6NC SERIES | 6-Inch Round Universal New Construction Housing

ORDERING INFORMATION

Example Order: -

| Housing/LED Series | Color Temp/CRI | Electrical | Dimming | Options |
|---------------------------|---------------------|------------------------------|--|--|
| R6NC1 - 12W/1100lm | 83 (80min) CRI | 12 - 120V | D1 - TRIAC, ELV, 0-10V Dimming | ER⁶ - Factory Installed 7W/200mA Emergency Battery Backup [Remote Test Switch] |
| R6NC2 - 16W/1600lm | 27K - 2700K | 27 - 277V | D2² - 347V 0-10V Dimming | |
| R6NC3 - 21W/2200lm | 30K - 3000K | 34² - 347V | D4³ - Lutron Hi-lume 1% EcoSystem Driver with Soft-on, Fade-to-Black | |
| R6NC4 - 30W/3000lm | 35K - 3500K | | D6⁴ - eldoLED ECOdrive, 0-10V, 1% Dimming | |
| R6NC5 - 38W/3700lm | 40K - 4000K | | D7⁴ - eldoLED ECOdrive, DALI, 1% Dimming | |
| R6NC6 - 45W/4100lm | 90+ CRI | | D8⁴ - eldoLED SOLOdrive, 0-10V, 0.1% Dimming | |
| | 27KC - 2700K | | D9⁴ - eldoLED SOLOdrive, DALI, 0.1% Dimming | |
| | 30KC - 3000K | | DMX^{4,5} - eldoLED POWERdrive, DMX 0.0% Dimming | |
| | 35KC - 3500K | | | |
| | 40KC - 4000K | | | |

as needed

 : These Model Options are eligible for **SpeedShip**

1. TRIAC and ELV Dimming for 120V only
2. 0-10V Dimming only dimming available for 347V option. Cannot be used with Emergency Battery Backup option.
3. Lutron Eco-System Driver is available for both 120V and 277V. Lutron Dimming options are available for Series 1 through 4 only (12W through 30W); not available for use with LED Series 5 or 6 (38W or 45W).
4. eldoLED Drivers are programmed for Linear Curve Dimming as standard; for Logarithmic Curve Dimming, consult factory
5. Verify DMX Driver and Control System compatibility with factory prior to ordering
6. Emergency Battery Backup option: 725 lumen nominal average for all wattages

ACCESSORIES

6-INCH SLOPE CEILING ADAPTERS

Standard Hanger Bars Supplied with Housing

- HB-30** - T-Bar Hanger Set
- RL-KIT** - Commercial Mounting Brackets
- HB-24** - 27-Inch Flat Hanger Bars for RL-KIT
- HBC-24** - 25-Inch C-Channel Hanger Bars for RL-KIT in Grid Ceiling Construction

- RSA6L-5-WHT** - 5° Pitch
- RSA6L-10-WHT** - 10° Pitch
- RSA6L-15-WHT** - 15° Pitch
- RSA6L-20-WHT** - 20° Pitch
- RSA6L-25-WHT** - 25° Pitch
- RSA6L-30-WHT** - 30° Pitch

See "Trims for 6-Inch LED Downlights" Specification Sheet for compatible Trim information and details

| DATE | PROJECT | TYPE |
|------|---------|------|
|------|---------|------|

R6NC SERIES | 6-Inch Round Universal New Construction Housing

PRODUCT DETAILS

Construction

- Specification Grade 6-inch Round 16 Gauge Galvanized Steel New Construction Housing with Die-Cast Aluminum Heat Sink
- Requires minimum 3-inch clearance around Housing from insulation material; thermal protection provided in case of improper insulation use
- Quick-connect Light Engine for easy installation and removal
- Drivers are fully accessible from below the ceiling and can be easily removed
- Dual Nailer Hanger Bars are adjustable for 16- and 24-inch center joists (14-1/4- to 24-1/2-inch). Nailer Bars may be extended to rest on T-Bar ceilings; optional clip-on T-Bar Hangers available.
- Pre-wired Junction Box with convenient Screwdriver Pry-outs plus three (3) 1/2-inch Knockouts and one (1) 1/2-inch x 3/4-inch Concentric Knockout
- Output over-voltage, over-current and short circuit protection
- Approved for Through Circuit Wiring: max. eight (8) 12 AWG (4in/4out), wiring rated to 90°C

Performance Summary

- 2700K, 3000K, 3500K and 4000K Color Temperatures; excellent fixture-to-fixture color consistency with a 3-step MacAdam Ellipse tolerance
- 80 CRI min., 83 typical; high 90+ CRI available
- All R6 Downlights are available for non-dimming and dimming applications; for compatible Dimmers, refer to the Dimming Specification Sheet
- Flanged or Trimless Specification Grade Trims available in several different styles and finishes
- Trimless options require use of a Mud Frame (MF6, ordered separately) for securing housing and trim in 1/2- to 1-inch ceiling thicknesses only
- **Trimless options cannot be used on Remodel Style Housings (R6RM) or with Slope Ceiling Adapters (RSA6L)**
- UL8750 and Class 2 Compliant; RoHS Compliant, US only



The following Models are eligible for SpeedShip:

Housing: R6NC435K12D

Trim: C6322W-CLR

| DATE | PROJECT | TYPE |
|------|---------|------|
|------|---------|------|

R6 SERIES | 6-Inch Round Downlight Trims

FLANGED TRIM OPTIONS



C6322-CLR
Clear Specular Reflector



C6322 Series
Specification Grade Reflector
5-3/4-Inch ID, 7-Inch OD
4-1/4-Inch Height

Specification Grade Reflector. For Wet Location approved trim, add “-C” for Clear Lens or “-SL” for Sandblast Lens after finish code.



C6323-CLR
Clear Reflector

C6323 Series
Lensed Wall Wash Reflector
5-5/8-Inch ID, 7-Inch OD, 4-1/4-Inch Height

- C6322N-CLR**¹ - Clear Specular Reflector: 32° Narrow Beam
- C6322M-CLR**¹ - Clear Specular Reflector: 65° Medium Beam
- C6322W-CLR**¹ - Clear Specular Reflector: 74° Wide Beam
- C6322-PL**¹ - 59° Platinum Reflector
- C6322-PLWHE** - 59° Platinum Wheat Reflector
- C6322-WHT** - 72° White Reflector

1. Available with White Painted Flange: add -WPF to end of part number

 : These Model Options are eligible for **SpeedShip**

Trim
C6323 - Lensed Wall Wash Reflector

Finish
CLR¹ - Clear
PL¹ - Platinum
WHT - White
1. Available with White Painted Flange: add -WPF to end of part number



C6321-WHT-PL
White Reflector/
Platinum Lower Cone



C6321 Series
Two Piece Reflector with Lower Cone and Flat Lens
5-3/4-Inch ID, 7-Inch OD
4-1/4-Inch Height

Two Piece Reflector: Upper Reflector, Lower Cone. Includes one (1) LF38-CL Clear Glass Lens. Approved for Wet Locations when Glass Lens is installed.



C6327-CLR-PL
Clear Reflector/Platinum Lower Cone/Regressed Prismatic Convex Lens



C6327 Series
Two Piece Reflector: Lower Cone with Prismatic Convex Lens
5-3/4-Inch ID, 7-Inch OD
4-1/4-Inch Height

Two Piece Reflector with Prismatic Convex Lens: Upper Reflector, Lower Cone, Prismatic Convex Lens with 1-1/2-inch regress. Wet Location Listed.

Reflector
C6321-CLR - Clear
C6321-WHT - White

Lower Cone
CLR - Clear
PL - Platinum

Reflector
C6327-CLR - Clear
C6327-WHT - White

Lower Cone
CLR - Clear
PL - Platinum



C6321-WHT-B
White Reflector/Black Baffle



C6321 Baffle Series
Two Piece Reflector with Lower Baffle and Flat Lens
5-3/4-Inch ID, 7-Inch OD
4-1/4-Inch Height

Two Piece Reflector: White Upper Reflector, Black or White Lower Baffle. Includes one (1) LF38-CL Clear Glass Lens. Approved for Wet Locations when Glass Lens is installed.



C6327-CLR-P
Clear Reflector/White Lower Baffle/Regressed Prismatic Convex Lens



C6327 Baffle Series
Two Piece Reflector: Lower Baffle with Prismatic Convex Lens
5-3/4-Inch ID, 7-Inch OD
4-1/4-Inch Height

Two Piece Reflector with Prismatic Convex Lens: Upper Reflector, Lower Baffle, Prismatic Convex Lens with 1-1/2-inch regress. Wet Location Listed.

Reflector
C6321-CLR - Clear
C6321-WHT - White

Lower Baffle
B - Black
P - White

Reflector
C6327-CLR - Clear
C6327-WHT - White

Lower Baffle
B - Black
P - White

| DATE | PROJECT | TYPE |
|------|---------|------|
|------|---------|------|

R6 SERIES | 6-Inch Round Downlight Trims

TRIMLESS OPTIONS

Trimless Options require use of Mud Frame accessory (MF6, ordered separately)



CN6322-CLR
Clear Specular Reflector



CN6322 Series
Specification Grade Trimless Reflector

5-7/8-Inch ID, 6-1/4-Inch OD,
4-1/4-Inch Height

Specification Grade Reflector. For use with 1/2- to 1-inch ceiling thicknesses only. For Wet Location approved trim, add “-C” for Clear Lens or “-SL” for Sandblast Lens after finish code. **Cannot be used on Remodel Housings (R6RM) or with Slope Ceiling Adapters (RSA6L).**



CN6323-CLR
Clear Reflector

CN6323 Series

Trimless Lensed Wall Wash Reflector
5-5/8-Inch ID; 6-1/4-Inch OD

For use with 1/2- to 1-inch ceiling thicknesses only. **Cannot be used on Remodel Housings (R6RM) or with Slope Ceiling Adapters (RSA6L).**

Trim
CN6323 - Lensed Wall Wash Reflector

Finish
CLR - Clear
PL - Platinum
WHT - White

- CN6322N-CLR** - Clear Specular Reflector: 32° Narrow Beam
- CN6322M-CLR** - Clear Specular Reflector: 65° Medium Beam
- CN6322W-CLR** - Clear Specular Reflector: 74° Wide Beam
- CN6322-PL** - 59° Platinum Reflector
- CN6322-WHT** - 72° White Reflector

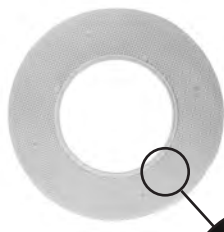

MF6
Round Mud Frame

Mud Frame

Required for use with trimless options

12-Inch OD

Die-cast Ring with Steel Mesh Frame. Painted white. **Required for use with trimless options.**

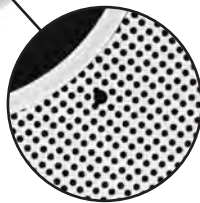

MF6 - 6-Inch Mud Frame

DATE

PROJECT

TYPE

R6 SERIES | 6-Inch Round Downlight Photometrics

R6NC630K12D / C6322N-CLR

Fixture Delivered Lumens: 4152.8
 Total Watts@120V: 45.0
 Lumens Per Watt: 92.3
 Center Beam Candle Power: 10628
 Beam Distribution: 31.5°
 Spacing Criterion: 0.53
 Color Rendering Index (CRI)¹: 83.4
 Color Temperature (CCT)²: 3065K
 Designed for 50,000 Hour Lamp Life³
 LM-63 Test No. G21070804
 LM-79 Test No. S21072002

| Intensity Distribution | | |
|------------------------|------------------|---------------------|
| DISTANCE (FT.) | FOOTCANDLES (FC) | BEAM DIAMETER (FT.) |
| 6 FT | 295.2 | 3.4 |
| 8 FT | 166.1 | 4.5 |
| 10 FT | 106.3 | 5.7 |
| 12 FT | 73.8 | 6.8 |
| 14 FT | 54.2 | 7.9 |
| 16 FT | 41.5 | 9.0 |

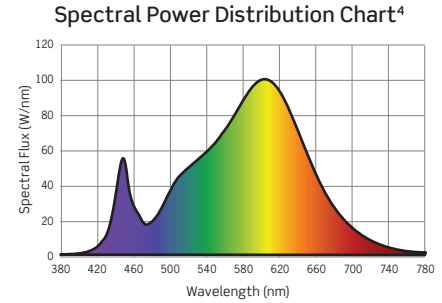
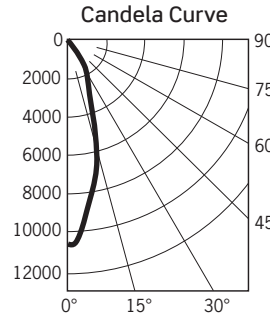

R6NC630K12D / C6322M-CLR

Fixture Delivered Lumens: 4069.6
 Total Watts@120V: 45.0
 Lumens Per Watt: 90.4
 Center Beam Candle Power: 4259
 Beam Distribution: 65.1°
 Spacing Criterion: 0.95
 Color Rendering Index (CRI)¹: 83.4
 Color Temperature (CCT)²: 3065K
 Designed for 50,000 Hour Lamp Life³
 LM-63 Test No. G21070803
 LM-79 Test No. S21072002

| Intensity Distribution | | |
|------------------------|------------------|---------------------|
| DISTANCE (FT.) | FOOTCANDLES (FC) | BEAM DIAMETER (FT.) |
| 6 FT | 118.3 | 7.7 |
| 8 FT | 66.5 | 10.2 |
| 10 FT | 42.6 | 12.8 |
| 12 FT | 29.6 | 15.3 |
| 14 FT | 21.7 | 17.9 |
| 16 FT | 16.6 | 20.4 |

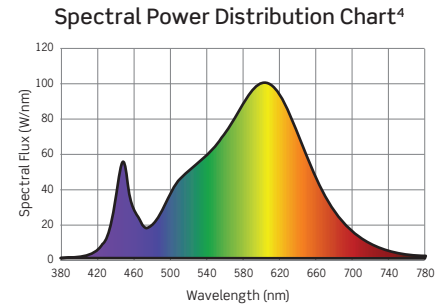
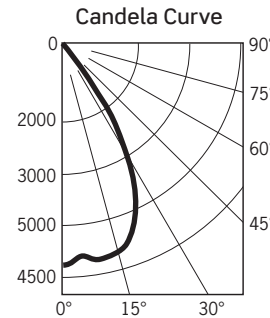

R6NC630K12D / C6322W-CLR

Fixture Delivered Lumens: 4197.4
 Total Watts@120V: 45.0
 Lumens Per Watt: 93.3
 Center Beam Candle Power: 3135
 Beam Distribution: 73.6°
 Spacing Criterion: 1.1
 Color Rendering Index (CRI)¹: 83.4
 Color Temperature (CCT)²: 3065K
 Designed for 50,000 Hour Lamp Life³
 LM-63 Test No. G21070806
 LM-79 Test No. S21072002

| Intensity Distribution | | |
|------------------------|------------------|---------------------|
| DISTANCE (FT.) | FOOTCANDLES (FC) | BEAM DIAMETER (FT.) |
| 6 FT | 87.1 | 9.0 |
| 8 FT | 49.0 | 12.0 |
| 10 FT | 31.3 | 15.0 |
| 12 FT | 21.8 | 17.9 |
| 14 FT | 16.0 | 20.9 |
| 16 FT | 12.2 | 23.9 |

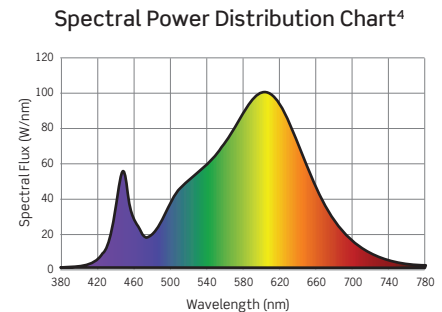
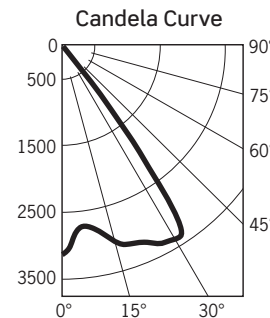

1. Accuracy of Rendering Colors 2. Color Appearance of Light Source 3. Dependent on Surrounding Temperatures 4. Colors Present within the Light Source

PHOTOMETRIC MULTIPLICATION FACTORS

Lumen output values fluctuate based on Color Temperature, Luminaire Wattage/Output and Trim Selection. To estimate lumen output of these various options, multiply 3000K results by the following:

| CCT MULTIPLIERS | | | OUTPUT MULTIPLIERS | | | | | TRIM MULTIPLIERS | |
|-----------------|---------|----------|--------------------|--------------|--------------|--------------|--------------|------------------|-----------|
| CCT | STD CRI | HIGH CRI | 12W/SERIES 1 | 16W/SERIES 2 | 21W/SERIES 3 | 30W/SERIES 4 | 38W/SERIES 5 | C6322-PL | C6322-WHT |
| 2700K | 0.94 | 0.70 | 0.28 | 0.39 | 0.54 | 0.72 | 0.88 | 1.02 | 0.92 |
| 3000K | N/A | 0.75 | | | | | | | |
| 3500K | 1.0 | 0.81 | | | | | | | |
| 4000K | 1.0 | 0.87 | | | | | | | |

DATE

PROJECT

TYPE

R6 SERIES | 6-Inch Round Downlight Photometrics

R6NC630K12D / C6322-PL

Fixture Delivered Lumens: 4141.0
 Total Watts@120V: 45.0
 Lumens Per Watt: 92.0
 Center Beam Candle Power: 5337
 Beam Distribution: 58.5°
 Spacing Criterion: 0.91
 Color Rendering Index (CRI)¹: 83.4
 Color Temperature (CCT)²: 3065K
 Designed for 50,000 Hour Lamp Life³
 LM-63 Test No. G21070805
 LM-79 Test No. S21072002

| DISTANCE (FT.) | FOOTCANDLES (FC) | BEAM DIAMETER (FT.) |
|----------------|------------------|---------------------|
| 6 FT | 148.3 | 6.7 |
| 8 FT | 83.4 | 9.0 |
| 10 FT | 53.4 | 11.2 |
| 12 FT | 37.1 | 13.5 |
| 14 FT | 27.2 | 15.7 |
| 16 FT | 20.8 | 17.9 |

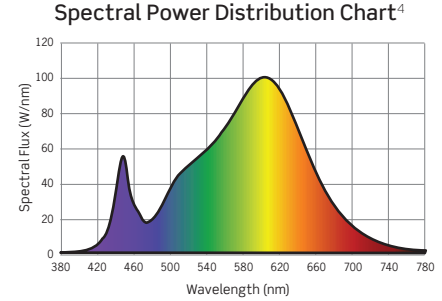
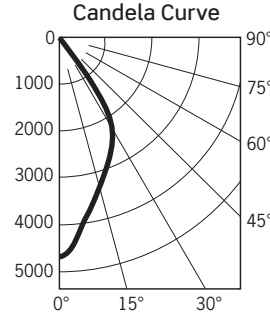

1. Accuracy of Rendering Colors
2. Color Appearance of Light Source
3. Dependent on Surrounding Temperatures
4. Colors Present within the Light Source

PHOTOMETRIC MULTIPLICATION FACTORS

Lumen output values fluctuate based on Color Temperature, Luminaire Wattage/Output and Trim Selection. To estimate lumen output of these various options, multiply 3000K results by the following:

| CCT MULTIPLIERS | | | OUTPUT MULTIPLIERS | | | | | TRIM MULTIPLIERS | |
|-----------------|---------|----------|--------------------|--------------|--------------|--------------|--------------|------------------|-----------|
| CCT | STD CRI | HIGH CRI | 12W/SERIES 1 | 16W/SERIES 2 | 21W/SERIES 3 | 30W/SERIES 4 | 38W/SERIES 5 | C6322-PL | C6322-WHT |
| 2700K | 0.94 | 0.70 | 0.28 | 0.39 | 0.54 | 0.72 | 0.88 | 1.02 | 0.92 |
| 3000K | N/A | 0.75 | | | | | | | |
| 3500K | 1.0 | 0.81 | | | | | | | |
| 4000K | 1.0 | 0.87 | | | | | | | |

DATE

PROJECT

TYPE

R6 SERIES | 6-Inch Round Downlight Photometrics

TM-30 DATA: R6NC630K12D / C6322M-CLR

ANSI/IES TM-30-18 Color Rendition Report Test No. S21072002

Colors are for visual orientation purposes only

| | |
|----------|--------|
| R_f | 86 |
| R_g | 97 |
| CCT(K) | 3065K |
| D_{uv} | 0.0017 |
| u^I | 0.2477 |
| v^I | 0.5224 |

Color Vector Graphic

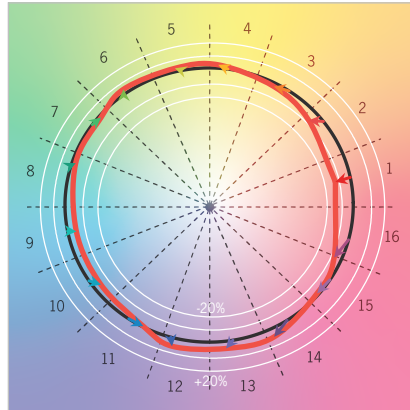

— Reference Illuminance — Test Source

Spectral Power Distribution Comparison

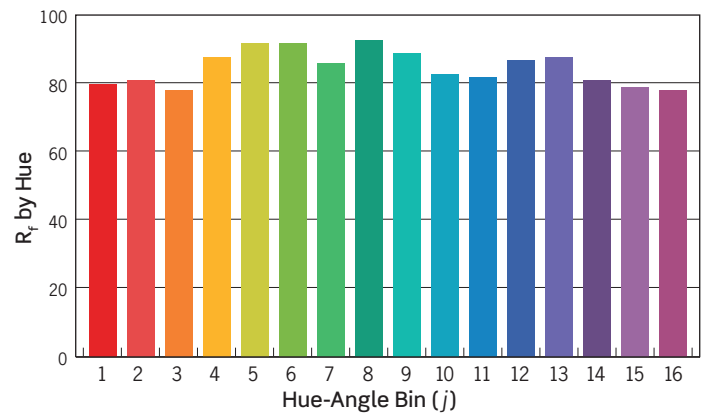
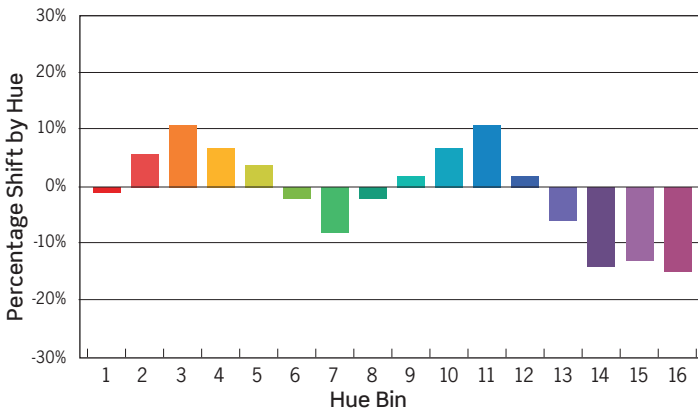
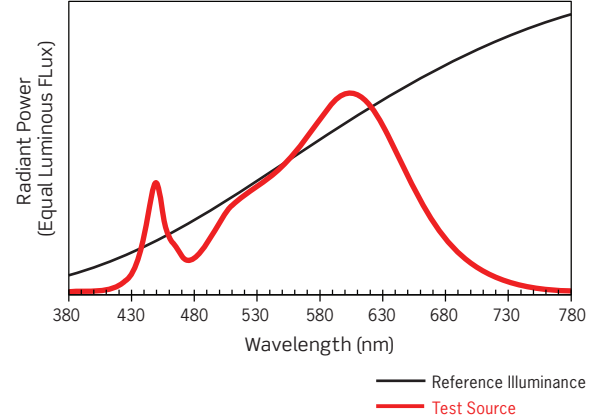

| HUE BIN | 1 | 2 | 3 | 4 | 5 | 6 | 7 | 8 | 9 | 10 | 11 | 12 | 13 | 14 | 15 | 16 |
|-------------|-----|----|-----|----|----|-----|-----|-----|----|----|-----|----|-----|------|------|------|
| HUE SHIFT | -1% | 6% | 11% | 7% | 4% | -2% | -8% | -2% | 1% | 7% | 11% | 2% | -6% | -14% | -13% | -15% |
| R_f VALUE | 81 | 82 | 79 | 88 | 93 | 93 | 87 | 94 | 91 | 85 | 83 | 88 | 89 | 82 | 80 | 80 |

DATE

PROJECT

TYPE

R6 SERIES | 6-Inch Round Downlights: Dimming Specifications

- Incandescent 120V AC Dimmers adjust the light with *Forward Phase Control*, where the Dimmer “chops” the forward part of the AC Wave to deliver less or more power to the light source. No Neutral Wire Connection required.
- Electronic Low Voltage 120V AC Dimmers adjust the light with *Reverse Phase Control*, where the Dimmer “chops” the back part of the AC Wave to deliver less or more power to the light source. Neutral Wire Connection required.
- 0–10V DC Low Voltage Dimmers operate using two (2) Low Voltage Dimming Wires that are separate from the 120V or 277V AC Power. The Dimmer sends a Variable Output Voltage to the luminaire based upon the dimming level. 10V Corresponds to undimmed operation, 5V to 50% and so on. Switching On/Off is controlled with the Line Voltage Power Input to the Dimmer (120V or 277V AC). Dimming operation is controlled with the 0–10V DC Low Voltage Wiring Connection between the Dimmer and the LED Driver. The Control Signal runs on two (2) low voltage control wires color coded Purple and Pink/Gray.
- Lutron EcoSystem Drivers provide continuous dimming from 1%–100%. For a complete list of compatible Dimmers and Controls, visit www.lutron.com
- Use DALI approved Controls for dimming eldoLED ECoDrive, 1% Dimming (Dimming Option MVD7) and eldoLED SOLOdrive, 0.1% Dimming (Dimming Option MVD9)

| | | | TRIAC, ELV, 0-10V* (12D, 27D, MVD) | eldoLED ECoDrive 0-10V (12D6, 27D6, MVD6) | eldoLED SOLOdrive 0-10V (12D8, 27D8, MVD8) |
|----------------|----------------|-----------|---------------------------------------|--|---|
| Manufacturer | Product | Model | Light Output | Light Output | Light Output |
| Leviton | IllumaTech | IPI06-1LZ | 1%-100% | N/A | N/A |
| Leviton | SureSlide | 6631-2 | 1%-100% | N/A | N/A |
| Leviton | Vizia | VPE06 | 9%-100% | N/A | N/A |
| Leviton | Trimatron | 6683-IW | 6%-100% | N/A | N/A |
| Leviton | Decora | 6161 | 15%-100% | N/A | N/A |
| Leviton | SureSlide | 6633-P | 1%-100% | N/A | N/A |
| Leviton | IllumaTech | IPE04 | 6%-100% | N/A | N/A |
| Leviton | IllumaTech | IP710-DLX | N/A | 1%-100% | 0.1%-100% |
| Cooper | Devine | DLC03P | 1%-100% | N/A | N/A |
| Cooper | Skye | SLC03P | 0%-100% | N/A | N/A |
| Cooper | Decorator | DAL06P | 0%-100% | N/A | N/A |
| Pass & Seymour | Titan | CD4FB-W | N/A | 1%-100% | 0.1%-100% |
| Synergy | | ISD BC | N/A | 1%-100% | 0.1%-100% |
| Watt Stopper | Miro Decorator | DCLV1 | N/A | 1%-100% | 0.1%-100% |
| Lutron | Ariadni | TGCL-153P | 1%-100% | N/A | N/A |
| Lutron | Ariadni | TG-600P | 13%-100% | N/A | N/A |
| Lutron | Diva | DVCL-153P | 1%-100% | N/A | N/A |
| Lutron | Diva | DV600P | 6%-100% | N/A | N/A |
| Lutron | Diva | DVELV303P | 6%-100% | N/A | N/A |
| Lutron | Diva | DVTV | N/A | 1%-100% | 0.1%-100% |
| Lutron | Faetra | FAELV500 | 12%-100% | N/A | N/A |
| Lutron | Lumea | LG600P | 8%-100% | N/A | N/A |
| Lutron | Maestro | MAELV600 | 16%-100% | N/A | N/A |
| Lutron | Nova | NFTV | N/A | 1%-100% | 0.1%-100% |
| Lutron | Nova T | NTFTV | N/A | 1%-100% | 0.1%-100% |
| Lutron | Skylark | S-603PG | 5%-96% | N/A | N/A |
| Lutron | Skylark | S600P | 5%-100% | N/A | N/A |
| Lutron | Skylark | SELV300P | 10%-100% | N/A | N/A |
| Lutron | Skylark | CT103P | 9%-100% | N/A | N/A |

*277V TRIAC Dimming is not available

NOTES

1. Testing was performed with a single luminaire connected to Dimmer.
2. Testing has been performed on these Dimmers, but this does not imply any warranty of compatibility.
3. Dimming performance can be influenced by different Loads, as well as variations in Dimmer Switches within the same Model.
4. Dimmer Maximum Load Rating with LED may differ from published Traditional Source Dimmer Ratings. Consult manufacturer for maximum Dimmer information.
5. Consult factory for additional dimming information.