

PROJECT NAME: \_\_\_\_\_ CAT. #: \_\_\_\_\_  
 NOTES: \_\_\_\_\_ FIXTURE SCHEDULE: \_\_\_\_\_

# Recessed Architectural Downlights

Wattage and Color Selectable



18W ENGINE WITH ROUND REFLECTOR    30W ENGINE WITH WALL WASHER    NEW CONSTRUCTION

### REFLECTORS



ROUND SILVER REFLECTOR & WHITE TRIM    ROUND WHITE REFLECTOR & WHITE TRIM  
 SQUARE SILVER REFLECTOR & WHITE TRIM



Wattage and CCT switch    Beam Angle Selector    Locking Mechanism

### Product Description:

Introducing the Recessed Architectural Downlight – a revolutionary modular system designed to future-proof your lighting solutions. Each light engine is packed with features, making it the simplest and most efficient way to upgrade incandescent, fluorescent, or metal halide downlights to state-of-the-art LEDs. The light engine offers three wattage options, five CCT selections, and two beam angles, all in one package. With its multi-mode dimming capabilities supporting Triac, ELV, and 0-10V dimming, as well as its 12v aux output that can be paired with Maxlite’s patented c-Max control system, this provides the most versatile Luminaire Level Lighting controls (LLLC) option for Downlights in the industry.

Paired with multiple sizes of downlight or wall-wash reflectors, this Energy Star 1.0 qualified downlight ensures top-tier energy efficiency and performance. Whether for retrofit or new construction, recessed architectural downlights provide the most cost-effective solution for replacing architectural downlights, delivering significant energy savings and superior lighting quality.

### Features:

- 12V Aux for c-Max compatibility
- Wattage and CCT select Light Engines with Adjustable Beam Angles
  - 12/16/20W Engine: 25°-45°; 18/24/30W Engine: 25°-45°;
  - 30/40/50W Engine: 30°-50°
- Downlight and Wall-Wash Reflectors available in Silver and White finish
- Multi-Mode dimming supporting Triac / ELV (at 120v) and 0-10V dimming (at 120-277V)
- 12V Aux for c-Max compatibility
- Field Installable Emergency Battery Back Up Available

### Multimode Dimming:

- 0-10v dimming 120-277V
- Triac / ELV 120V only

### Listings:

- ETL Listed for damp locations, indoor
- ETL Classified for damp locations, indoor
- Energy Star V1.0 qualified

## Ordering Information

### Step 1 - Select the light engine

FAMILY	DIMMING MODE	-	WATTAGE	CCT	SOURCE
<b>RAD</b> = Recessed Architectural Downlight Light Engine	<b>M</b> = Multi-Mode (0-10V & TRIAC)	-	<b>12W</b> = 12/16/20W Selectable <b>18W</b> = 18/24/30W Selectable <b>30W</b> = 30/40/50W Selectable	<b>CS</b> = 27/30/35/40/50 CCT Selectable	<b>[BLANK]</b> = Blank <b>TA</b> = TAA Compliant

### Step 2 - Select the reflector

FAMILY	TYPE	-	SIZE	REFLECTOR FINISH	FLANGE FINISH	SOURCE
<b>RAD</b> = Recessed Architectural Downlight Reflector	<b>R</b> = Round	-	<b>4</b> = 4" reflector** <b>6</b> = 6" reflector <b>8</b> = 8" reflector <b>10</b> = 10" reflector	<b>M</b> = Matte Silver <b>W</b> = White	<b>W</b> = White	<b>[BLANK]</b> = Blank <b>TA</b> = TAA Compliant
	<b>W</b> = Round Wall Wash	-	<b>6</b> = 6" reflector <b>8</b> = 8" reflector <b>10</b> = 10" reflector***			
	<b>RS</b> = Square	-	<b>4</b> = 4" reflector*** <b>6</b> = 6" reflector <b>8</b> = 8" reflector	<b>M</b> = Matte Silver		

\*\*Not compatible for 30W engine | \*\*\* Special Order only | For new construction, order CDFK-4-10IN/2PK (sold separately)



# Recessed Architectural Downlights Wattage and Color Selectable

## Stocked Items (Engines)

MODEL NUMBER	ORDER CODE	ENERGY STAR
RADM-12WCS	112673	<a href="#">3999598</a>
RADM-18WCS	112674	<a href="#">3999599</a>
RADM-30WCS	112675	<a href="#">3999600</a>
RADM-12WCSTA	112315	<a href="#">3999598</a>
RADM-18WCSTA	112316	<a href="#">3999599</a>
RADM-30WCSTA	112317	<a href="#">3999600</a>

## Stocked Items (Round Reflectors)

MODEL NUMBER	ORDER CODE	REFLECTOR COLOR	TRIM COLOR	REFLECTOR SIZE
RADR-4MW	112676	Silver	White	4"
RADR-4WWTA	112325	White	White	4"
RADR-6MW	112677	Silver	White	6"
RADR-6WWTA	112326	White	White	6"
RADR-8MW	112678	Silver	White	8"
RADR-8WWTA	112327	White	White	8"
RADR-10MW	112679	Silver	White	10"

## Stocked Items (Wall Wash Reflectors)

MODEL NUMBER	ORDER CODE	REFLECTOR COLOR	TRIM COLOR	REFLECTOR SIZE
RADW-6MWTA	112322	Silver	White	6"
RADW-8MWTA	112323	Silver	White	8"

## Stocked Items (Square Reflectors)

MODEL NUMBER	ORDER CODE	REFLECTOR COLOR	TRIM COLOR	REFLECTOR SIZE
RADRS-4MWTA	113837	Silver	White	4"
RADRS-6MWTA	113839	Silver	White	6"
RADRS-8MWTA	113841	Silver	White	8"

## Specifications

		RADM-12WCS	RADM-18WCS	RADM-30WCS
		<b>LUMENS (lm) @ 2700K</b>	1150/1500/1800	1900/2400/2800
<b>CRI</b>	≥ 90			
<b>CCT (K)</b>	2700K/3000K/3500K/4000K/5000K CCT Selectable (Default CCT: 2700K)			
<b>L70 LIFETIME ( hrs)</b>	≥ 50,000			
<b>VOLTAGE</b>	120-277V, 120V			
<b>POWER FACTOR</b>	≥ 0.9			
<b>BBU</b>	Available (see accessory table)			
<b>LISTINGS</b>	ETL Listed & Classified, ENERGY STAR V1.0			
<b>ENVIRONMENT</b>	Damp locations			
<b>WARRANTY</b>	5 years			

## BBU Lumen Output - EBUUP17015N200B

Model Number	Wattage Setting	EM lumen - 90 mins
RADM-12WCS	12W	Min 600lm
	16W	Min 800lm
	20W	Min 1000lm
RADM-18WCS	18W	Min 1000lm
	24W	Min 1100lm
	30W	Min 1100lm

## BBU Lumen Output - EBUUP17015N200B

Model Number	Wattage Setting	EM lumen - 90 mins
RADM-30WCS	30W	Min 1100lm
	40W	Min 1100lm
	50W	Min 1100lm



# Recessed Architectural Downlights Wattage and Color Selectable

## Compatible Dimmers

DIMMER BRAND	SERIES	DIMMER MODEL	DIMMING
LEVITON	-	IP710-LFZ	0-10V
LEVITON	-	DVSTV-WH	0-10V
COOPER	-	DF10PC1	0-10V
LEGRAND	Radiant	RHCL453PTC	TRIAC
LEGRAND	Harmony	DCL453PTCCCV6	TRIAC
LEGRAND	Harmony	HCL453PTCCCV6	TRIAC

## Compatible Dimmers

DIMMER BRAND	SERIES	DIMMER MODEL	DIMMING
LEVITON	Sureslide	Cat.NO.6674	TRIAC
LEVITON	Illumena Tech	R50-IPL06-10M	TRIAC
LUTRON	Maestro C-L	MACL-153M	TRIAC
LUTRON	Skylark C-L	SCL-153P	TRIAC
LUTRON	Diva C-L	DVCL-153P	TRIAC
LUTRON		TGCL-153PH-WH	TRIAC
LUTRON	Skylark	CTCL-153PDH-WH	TRIAC
LUTRON	Diva C-L	DWCL-153PH-WH	TRIAC

## Accessories Table (Sold Separately)

ORDER CODE	MODEL NUMBER	DESCRIPTION	IMAGE
109999	CDFK-4-10IN/2PK	COMMERCIAL DOWNLIGHT FRAME KIT, NEW CONSTRUCTION, 4", 6", 8" & 10" SIZE - 2 PACK	
108566	EBUUP17015N200B	EMERGENCY INVERTER, 15W, 120-347VAC, CEC COMPLIANT, FIELD INSTALLABLE	

## c-Max Controls Microsites and Compatibility Guide

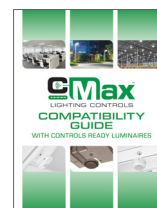

Product Compatibility Guide

## Compatible Controls (SOLD SEPARATELY)+

The table below shows a small subset of control nodes from each tier works with the fixture. Refer to individual microsites above for more accessories that could be added based on application requirements.

ORDER CODE	MODEL NUMBER & LINK TO DATA SHEET	DESCRIPTION	QR CODE TO DATA SHEET	IMAGE
<b>c-Max Network</b>				
105895	<a href="#">NN-MGT</a>	NETWORK NODE MAGNET, TRANSLUCENT		
107791	<a href="#">CNSL-PSW</a>	C-MAX NETWORK SENSOR 12V, BLUETOOTH/ PIR MOTION SENSOR / DAYLIGHT HARVEST, WHITE		
<b>c-Max Network Partners - Silvaire</b>				
112395	<a href="#">NN-MGT-SL</a>	SILVAIRE NETWORK NODE MAGNET, TRANSLUCENT		
111145	<a href="#">CNSL-PSW-SL</a>	SILVAIRE CEILING SENSOR 12-24V, BLUETOOTH/ PIR MOTION SENSOR, DAYLIGHT HARVEST, WHITE		

## Recessed Architectural Downlights

*Wattage and Color Selectable*

### Dimensions

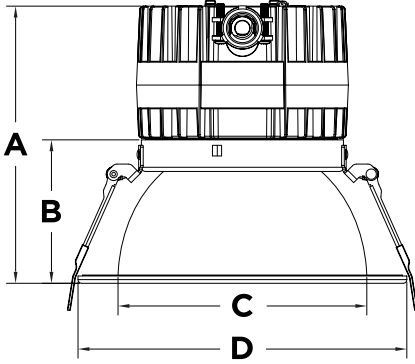

Round Reflector

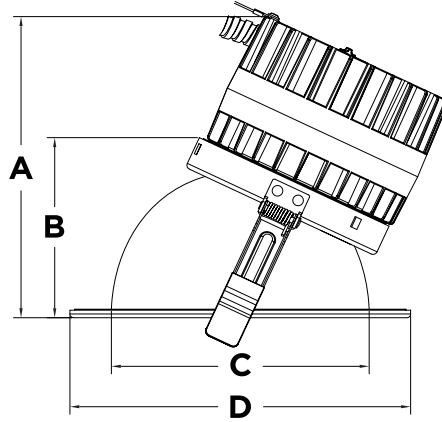

Wall Washer Reflector

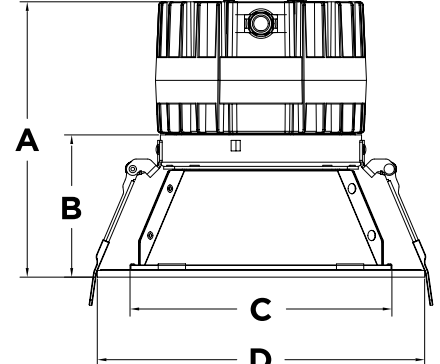

Square Reflector

LIGHT ENGINE	REFLECTOR TYPE	REFLECTOR SIZE	FIXTURE HEIGHT (A)	REFLECTOR HEIGHT (B)	INNER DIAMETER (C)	OUTER DIAMETER (D)	CUT-OUTS (INCHES)
RADM-12WCS** RADM-18WCS**	ROUND	4"	5.39	2.56	4.07	5.51	4.84-5.04
		6"	5.98	3.07	5.24	7.09	6.22-6.50
		8"	6.5	3.62	7.09	9.06	7.28-7.72
		10"	7.05	4.17	8.9	11.02	9.13-9.76
RADM-30WCS**	ROUND	6"	5.94	3.07	5.24	7.09	6.22-6.50
		8"	6.46	3.62	7.09	9.06	7.28-7.72
		10"	7.01	4.17	8.9	11.02	9.13-9.76
RADM-12WCS** RADM-18WCS**	WALL WASHER	6"	6.26	3.74	5.24	7.09	6.22-6.50
		8"	6.81	4.19	7.09	9.06	7.28-7.72
		10"	7.24	4.65	8.9	11.02	9.13-9.76
RADM-30WCS**	WALL WASHER	6"	6.5	3.74	5.24	7.09	6.22-6.50
		8"	7.01	4.19	7.09	9.06	7.28-7.72
		10"	7.44	4.65	8.9	11.02	9.13-9.76
RADM-12WCS** RADM-18WCS**	SQUARE	4"	5.61	2.72	4.49	5.91	Square 4.84-5.04
		6"	5.96	3.08	5.67	7.09	Square 6.22-6.50
		8"	6.49	3.61	7.64	9.06	Square 7.71-8.11
RADM-30WCS**	SQUARE	6"	5.91	3.08	5.67	7.09	Square 6.22-6.50
		8"	6.44	3.61	7.64	9.06	Square 7.71-8.11

# Recessed Architectural Downlights Wattage and Color Selectable

## Polar Candela Distribution – 12W

RADM-12WCS with 6" Round Reflector – 12W Setting @ 25° - 2700K

**Polar Candela Distribution**

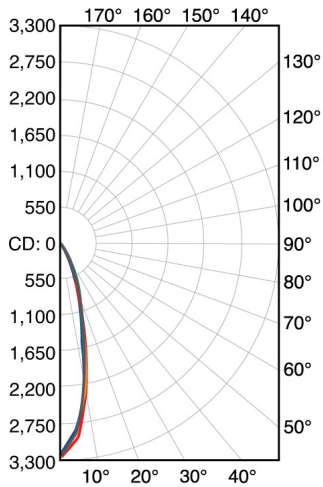

CP SUMMARY	
ANGLE	CANDELA
0°	3254
5°	2865
15°	1369
25°	548
35°	169
45°	55
55°	13
65°	2
75°	1
85°	0
90°	0

- Max. Cd
- 0° H
- 90° H
- 22.5° H
- 45° H
- 67.5° H

RADM-12WCS with 6" Wall Reflector – 12W Setting @ 25° - 2700K

**Polar Candela Distribution**

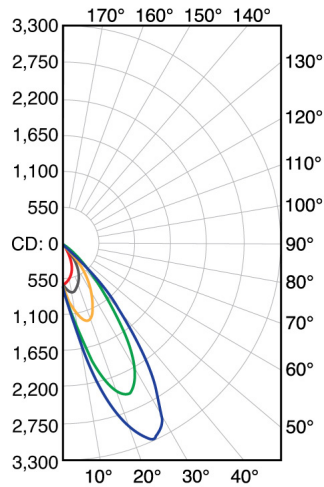

CP SUMMARY	
ANGLE	CANDELA
0°	590
5°	891
15°	2238
25°	3265
35°	2394
45°	882
55°	191
65°	15
75°	4
85°	0
90°	0

- Max. Cd
- 0° H
- 90° H
- 22.5° H
- 45° H
- 67.5° H

RADM-12WCS with 6" Round Reflector – 12W Setting @ 45° - 2700K

**Polar Candela Distribution**

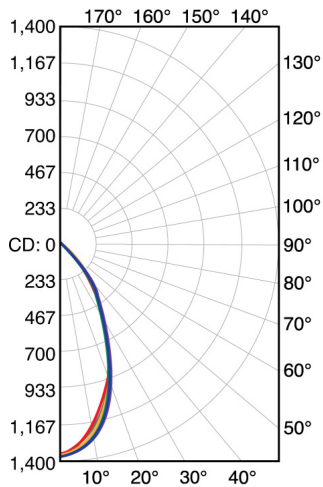

CP SUMMARY	
ANGLE	CANDELA
0°	1366
5°	1353
15°	1144
25°	732
35°	403
45°	153
55°	10
65°	2
75°	1
85°	0
90°	0

- Max. Cd
- 0° H
- 90° H
- 22.5° H
- 45° H
- 67.5° H

RADM-12WCS with 6" Wall Reflector – 12W Setting @ 45° - 2700K

**Polar Candela Distribution**

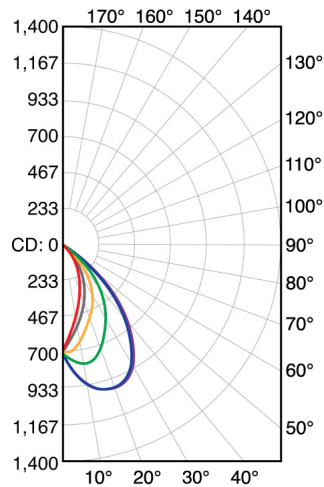

CP SUMMARY	
ANGLE	CANDELA
0°	687
5°	813
15°	955
25°	944
35°	750
45°	441
55°	58
65°	5
75°	1
85°	0
90°	0

- Max. Cd
- 0° H
- 90° H
- 22.5° H
- 45° H
- 67.5° H

# Recessed Architectural Downlights Wattage and Color Selectable

## Polar Candela Distribution – 12W

RADM-12WCS with 6" Square Reflector – 12W Setting @ 25° - 2700K

RADM-12WCS with 6" Square Reflector – 12W Setting @ 45° - 2700K

**Polar Candela Distribution**

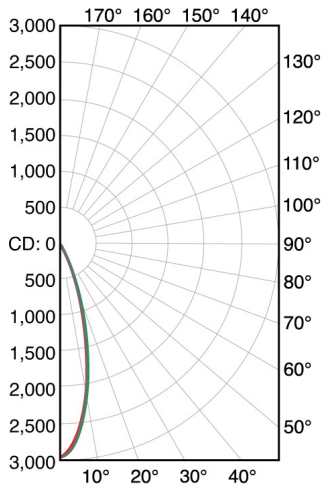

CP SUMMARY	
ANGLE	CANDELA
0°	5789
5°	5313
15°	2532
25°	985
35°	478
45°	164
55°	37
65°	13
75°	6
85°	2
90°	0

- Max. Cd
- 0° H
- 90° H
- 22.5° H
- 45° H
- 67.5° H

**Polar Candela Distribution**

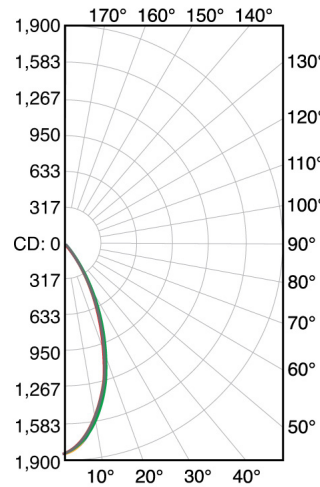

CP SUMMARY	
ANGLE	CANDELA
0°	1832
5°	1728
15°	1350
25°	801
35°	408
45°	40
55°	5
65°	2
75°	1
85°	1
90°	0

- Max. Cd
- 0° H
- 90° H
- 22.5° H
- 45° H
- 67.5° H

# Recessed Architectural Downlights Wattage and Color Selectable

## Polar Candela Distribution – 18W

RADM-18WCS with 6" Round Reflector – 18W Setting @ 25° - 2700K

**Polar Candela Distribution**

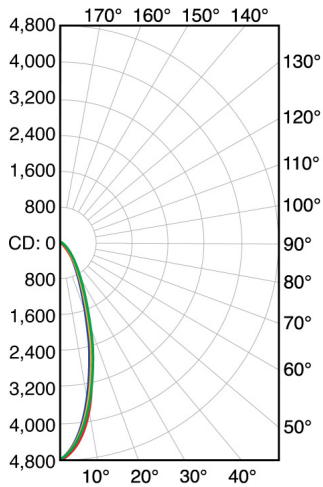

CP SUMMARY	
ANGLE	CANDELA
0°	4752
5°	4280
15°	2296
25°	947
35°	438
45°	108
55°	24
65°	3
75°	1
85°	0
90°	0

- Max. Cd
- 0° H
- 90° H
- 22.5° H
- 45° H
- 67.5° H

RADM-18WCS with 6" Wall Reflector – 18W Setting @ 25° - 2700K

**Polar Candela Distribution**

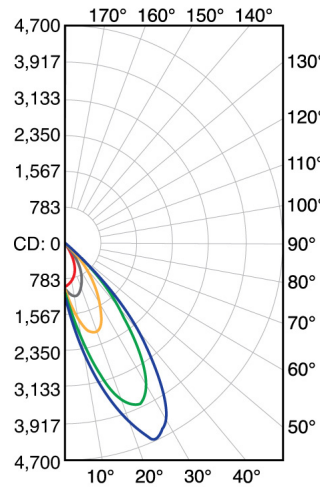

CP SUMMARY	
ANGLE	CANDELA
0°	921
5°	1423
15°	3308
25°	4682
35°	3610
45°	1533
55°	396
65°	25
75°	1
85°	0
90°	0

- Max. Cd
- 0° H
- 90° H
- 22.5° H
- 45° H
- 67.5° H

RADM-18WCS with 6" Round Reflector – 18W Setting @ 45° - 2700K

**Polar Candela Distribution**

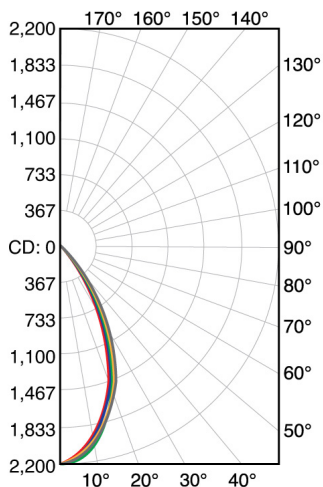

CP SUMMARY	
ANGLE	CANDELA
0°	2189
5°	2153
15°	1790
25°	1175
35°	616
45°	236
55°	21
65°	4
75°	2
85°	1
90°	0

- Max. Cd
- 0° H
- 90° H
- 22.5° H
- 45° H
- 67.5° H

RADM-18WCS with 6" Wall Reflector – 18W Setting @ 45° - 2700K

**Polar Candela Distribution**

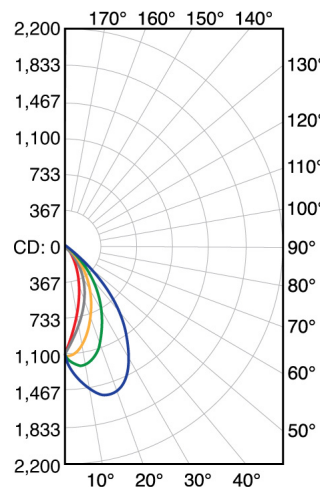

CP SUMMARY	
ANGLE	CANDELA
0°	1103
5°	1311
15°	1551
25°	1474
35°	1092
45°	623
55°	95
65°	10
75°	1
85°	0
90°	0

- Max. Cd
- 0° H
- 90° H
- 22.5° H
- 45° H
- 67.5° H

# Recessed Architectural Downlights Wattage and Color Selectable

## Polar Candela Distribution – 18W

RADM-18WCS with 6" Square Reflector – 18W Setting @ 25° - 2700K

RADM-18WCS with 6" Square Reflector – 18W Setting @ 45° - 2700K

**Polar Candela Distribution**

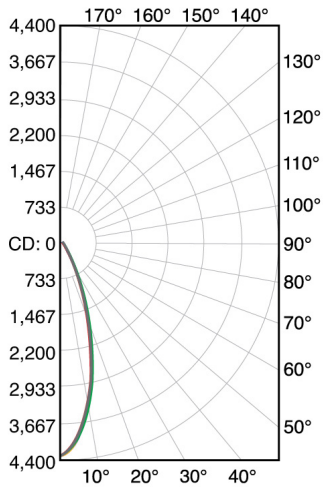

CP SUMMARY	
ANGLE	CANDELA
0°	4325
5°	4011
15°	2389
25°	979
35°	439
45°	109
55°	17
65°	2
75°	1
85°	1
90°	0

- Max. Cd
- 0° H
- 90° H
- 22.5° H
- 45° H
- 67.5° H

**Polar Candela Distribution**

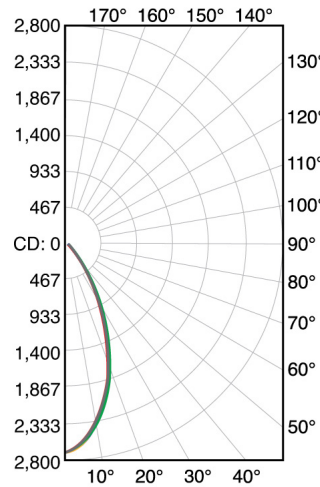

CP SUMMARY	
ANGLE	CANDELA
0°	2705
5°	2586
15°	2036
25°	1329
35°	649
45°	96
55°	11
65°	2
75°	1
85°	1
90°	0

- Max. Cd
- 0° H
- 90° H
- 22.5° H
- 45° H
- 67.5° H

# Recessed Architectural Downlights Wattage and Color Selectable

## Polar Candela Distribution – 30W

RADM-30WCS with 6" Round Reflector – 30W Setting @ 30° - 2700K

**Polar Candela Distribution**

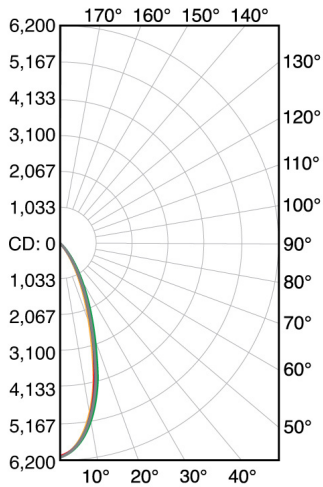

CP SUMMARY	
ANGLE	CANDELA
0°	6103
5°	5795
15°	3876
25°	1651
35°	762
45°	205
55°	46
65°	7
75°	3
85°	1
90°	0

- Max. Cd
- 0° H
- 90° H
- 22.5° H
- 45° H
- 67.5° H

RADM-30WCS with 6" Wall Reflector – 30W Setting @ 30° - 2700K

**Polar Candela Distribution**

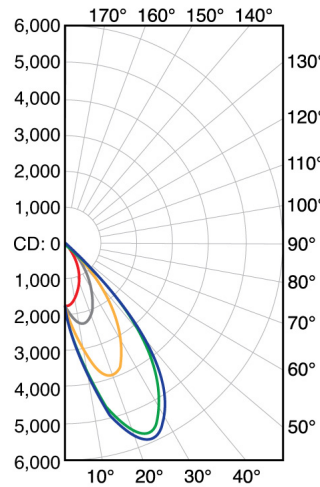

CP SUMMARY	
ANGLE	CANDELA
0°	1667
5°	2566
15°	4852
25°	5929
35°	4759
45°	2245
55°	492
65°	35
75°	2
85°	1
90°	0

- Max. Cd
- 0° H
- 90° H
- 22.5° H
- 45° H
- 67.5° H

RADM-30WCS with 6" Round Reflector – 30W Setting @ 50° - 2700K

**Polar Candela Distribution**

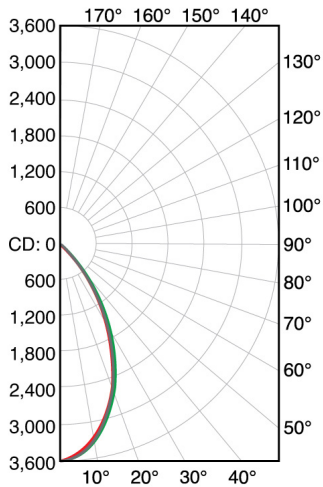

CP SUMMARY	
ANGLE	CANDELA
0°	3549
5°	3507
15°	2946
25°	2139
35°	1227
45°	485
55°	43
65°	6
75°	2
85°	1
90°	0

- Max. Cd
- 0° H
- 90° H
- 22.5° H
- 45° H
- 67.5° H

RADM-30WCS with 6" Wall Reflector – 30W Setting @ 50° - 2700K

**Polar Candela Distribution**

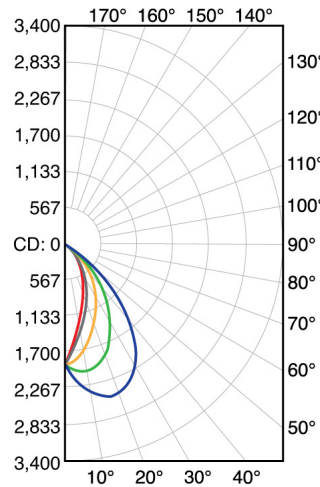

CP SUMMARY	
ANGLE	CANDELA
0°	1861
5°	2137
15°	2447
25°	2353
35°	1859
45°	1133
55°	161
65°	14
75°	2
85°	0
90°	0

- Max. Cd
- 0° H
- 90° H
- 22.5° H
- 45° H
- 67.5° H

## Recessed Architectural Downlights

*Wattage and Color Selectable*

### Polar Candela Distribution – 30W

RADM-30WCS with 6" Square Reflector – 30W Setting @ 30° - 2700K

#### Polar Candela Distribution

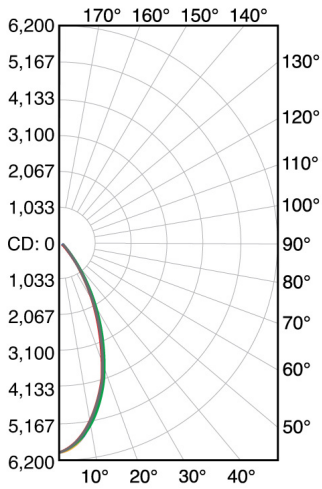

CP SUMMARY	
ANGLE	CANDELA
0°	6155
5°	5794
15°	3796
25°	1763
35°	771
45°	198
55°	30
65°	3
75°	2
85°	1
90°	0

- Max. Cd
- 0° H
- 90° H
- 22.5° H
- 45° H
- 67.5° H

RADM-30WCS with 6" Square Reflector – 30W Setting @ 50° - 2700K

#### Polar Candela Distribution

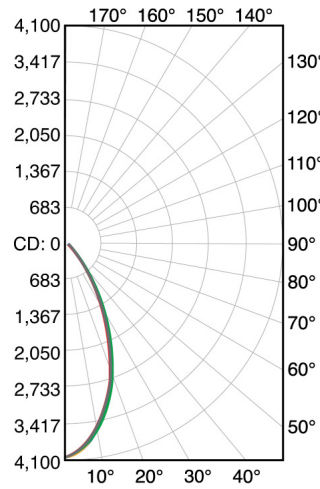

CP SUMMARY	
ANGLE	CANDELA
0°	4048
5°	3890
15°	3112
25°	2115
35°	1111
45°	205
55°	20
65°	4
75°	2
85°	2
90°	0

- Max. Cd
- 0° H
- 90° H
- 22.5° H
- 45° H
- 67.5° H