

Project		Catalog #		Type	
Prepared by		Notes		Date	



Metalux

24GR LED

2' x 4' LED Troffer
General Recessed LED Troffer
For Use in Insulated Ceilings

Typical Applications

- Office • Schools • Residential • Hospitals • Retail Merchandising Areas

Interactive Menu

- Order Information [page 2](#)
- Photometric Data [page 3](#)
- Control Solutions [page 5](#)
- VividTune™ Color Tuning Solutions [page 6](#)
- Product Warranty

Product Certification



Product Features



Top Product Features

- Available in 2' x 4', 2' x 2' and 1' x 4'
- Multiple lumen packages up to 18,000 in 2x4 and 9,000 in 2x2
- Up to 140 lm/W for maximum energy savings versus fluorescent troffers
- Correlated Color Temperatures 3000K, 3500K, 4000K and 5000K at 80 and 90 CRI
- Standard 0-10V continuous dimming driver
- Options to meet Build America, Buy America, Buy American and other domestic preference requirements

Dimensional and Mounting Details

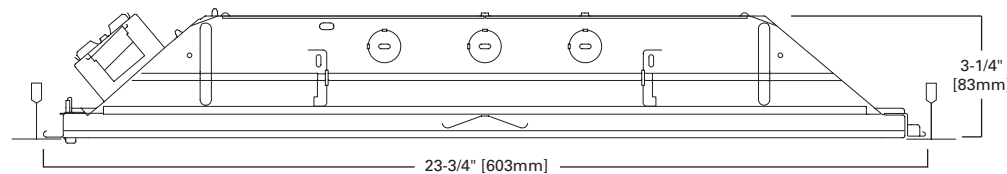

Door Frames



Mounting Data

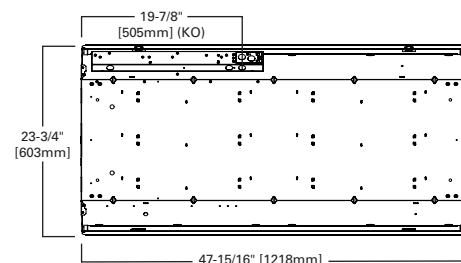

Ceiling Compatibility

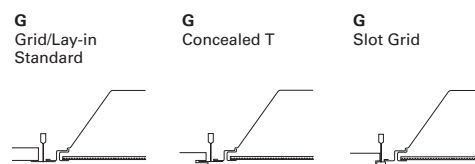

Ceiling Type	Trim Type
Exposed Grid	G
Concealed T	G
Slot Grid	G

(Verify compatibility/ consult factory.)

Order Information SAMPLE ORDER NUMBER: 24GR-LD5-48-F1-UNV-L835-CD1-U

Domestic Preferences ⁽¹⁾	Rating	Width/Length	Trim Type	Series ⁽³⁾	Door Frame	LED Type	LED Lumen Output ⁽⁵⁾	Shielding
[Blank] =Standard BAA =Buy American Act TAA =Trade Agreements Act BABA =Build America Buy America Act	[Blank] =Standard ATW-SW4 =Chicago Rated	24=2' x 4'	G =Grid/Lay-in (Standard) ⁽²⁾ G=C =Concealed T G= Slot Grid	R =General Purpose Troffer	Standard =Flat White Steel Door (Leave Blank) ⁽⁴⁾ FA =Flush White Extruded Aluminum c/w Spring Latch RA =Regressed White Extruded Aluminum FAN =Flush Natural Anodized Extruded Aluminum RAN =Regressed Natural Anodized Extruded Aluminum FAB =Flush Black Extruded Aluminum RAB =Regressed Black Extruded Aluminum	LD5=LED 5.0	30 =3000 34 =3400 38 =3800 42 =4200 48 =4800 56 =5600 64 =6400 72 =7200 ⁽⁸⁾ 85 =8500 ^{(7),(8)} 90 =9000 ^{(6),(8)} 100 =10000 ^{(6),(8)} 120 =12000 ^{(6),(8)} 130 =13000 ^{(6),(8)} 150 =15000 ^{(6),(8),(9)} 180 =18000 ^{(6),(8),(9)}	F1 =Pattern 12, Frosted Acrylic, 0.095" thick F125 =Pattern 12, Frosted Acrylic, 0.125" thick A =Pattern 12, Clear Acrylic, 0.095" thick A125 =Pattern 12, Clear Acrylic, 0.125" thick A19/156 =Pattern 19, Clear Acrylic, 0.156" thick ⁽¹⁰⁾ FGW080 =Frosted Smooth Acrylic, 0.080" thick A/WG =0.095" Pattern 12 Clear Acrylic Lens, with Wireguard directly below lens
Notes (1) Only product configurations with these prefixes are built to be compliant with the Buy American Act of 1933 (BAA), Trade Agreements Act of 1979 (TAA), or the Build America Buy America Act (BABA). BABA is the minimum Government compliance requirement for the Build America Buy America standards which is part of the Infrastructure and Investment Jobs Act (IIJA). Individual Government Agencies may have more stringent compliance standards. Please refer to DOMESTIC PREFERENCES website or consult the CLS Domestic Preferences team for more information. Components shipped separately may be separately analyzed under domestic preference requirements.			Notes (2) An EQ Grid Clip is recommended for all 9/16" ceiling systems.	Notes (3) DesignLights Consortium [®] Qualified and classified for DLC Standard, refer to www.designlights.org for details.	Notes (4) Only Standard door frames can support wireguard accessory.		Notes (5) Nominal lumen output. See table for actual values. (6) White tuning not available with this model. (7) The maximum lumens on this version with VividTune option will be 8300, see IES files for actual performance values. (8) Not compatible with WN driver. (9) XMFR required for 15000 lumens and up.	Notes (10) A19/156 lens creates holographic effect on the surface of the lens.

Voltage ⁽¹¹⁾	Options	Emergency	CCT	Factory Wiring	Driver Type
347V =347 Volt ⁽¹³⁾ UNV =Universal Voltage 120-277 ⁽¹²⁾ 120V =120 Volt ⁽¹⁴⁾ 277V =277 Volt ⁽¹⁴⁾	GL =Single Element Fuse GM =Double Element Fuse	EL7W =7-watt 120V-277V emergency battery pack ⁽¹⁵⁾ EL10W =10-watt 120V-277V emergency battery pack ⁽¹⁵⁾ EL14W =14-watt 120V-277V emergency battery pack ⁽¹⁵⁾ EL10WSD =10W emergency battery pack with self-diagnostic installed ^{(15),(16)} EL14WSD =14W emergency battery pack with self-diagnostic installed ^{(15),(16)} GTR2 =Bodine Generator Transfer Relay ^{(16),(17)} ETRD =Emergency Transfer Relay with dimming control ⁽¹⁶⁾	L830 =3000K L835 =3500K L840 =4000K L850 =5000K L930 =90CRI, 3000K L935 =90CRI, 3500K L940 =90CRI, 4000K L950 =90CRI, 5000K L83050 =80CRI 3000K-5000K White Tuning ⁽¹⁹⁾ L93050 =90CRI 3000K-5000K White Tuning ⁽¹⁹⁾ L82765 =80CRI 2700K-6500K White Tuning ⁽¹⁹⁾ L92765 =90CRI 2700K-6500K White Tuning ⁽¹⁹⁾	A3/8-4/18GDIM =3/8" Flex with 0-10V Dimming Leads Multiple other configurations available. See below for details. A3/8-5/18GDIM =Flex with 0-10V Dimming leads and Blue for alternate wiring. See below for details.	CD =0-10V Driver (10%-100% Dimming) ⁽²²⁾ HCD = 0-10V Driver (1%-100% Dimming) ⁽²²⁾ SLTD =DALI Driver (5%-100% Dimming) ⁽²¹⁾ SLTHD =DALI Driver (1%-100% Dimming) SD =Step Dimming Driver (50% or 100% Dimming) ⁽²⁰⁾ LH =Lutron HiLume (LDE1 series) 1%-100% EcoSystem Driver with Soft-on Fade to Black dimming ^(F) W2A =White Tuning, 2 ch, Intensity and CCT Control ⁽²³⁾ SR =Sensor-ready Driver (1%-100% Dimming)
Notes (11) Products also available in non-US voltages and frequencies for international markets. (12) Not available when specifying emergencies, voltage must be specific. (13) 347V is not available with the W2A driver. (14) Must specify voltage as 120V or 277V when ordering GTR2 option.		Notes (15) Factory installed with integral test switch/indicator/laser test. For approximate delivered lumens multiply the lumens per watt of the desired fixture by the wattage of the emergency battery pack (100 lm/W x 7=700 lumens). IES-format photometry for luminaire under emergency operation available. Battery option increases total height by 1 inch. (16) Used to bypass local control during outage. Must be used in conjunction with UL 1008 device (provided by others). GTR2 option includes 2 relays on fixtures with dimming drivers. ETRD option only requires one relay when used on a dimming fixture. (17) Must specify voltage as 120V or 277V when ordering GTR2 option. (18) EL10WSD and EL14WSD not available with 347V.	Notes (19) White tuning provides correlated color temperatures (CCT) between 3000K (warm) to 5000K (cool) or 2700K (warm) to 6500K (cool). Must be used in conjunction with W2A.	Flexible Metal Conduit Options Flex options available for 0-10V dimming control, DALI dimming control, emergency and night light functions. 72-inch factory-installed and pre-wired to driver, fitted to luminaire housing access plate with 90° enclosed FMC connector. Not all options may be combined and installation ratings vary by type. A3/8-4/18GDIM series notes: Factory installed dimming option 3/8" flexible metal conduit with 2-#18 power and ground wires and 2-#18 UL-listed jacketed 0-10V +/- control wires. Meets UL 66, 83, 1479, 1569, 1581, 2556, NEC® 250.118, 300.22(C), 392, 396, 330, 501, 502, 503, 530, 504, 505, 518, 520, 530, 645, 72; Federal Specification A-A-59544 (formerly J-C-30B); all applicable OSHA and HUD Requirements. UL Classified 1-, 2-, and 3-hour through penetration with applicable fire stop product (not included). May be surface mounted, fished and/or embedded in plaster. Cable tray and approved raceway rated, install per NEC®; Environmental Air-Handling Space Installation per NEC® 300.22(C).	Notes (20) Step dimming (bi-level) 1 driver, 4200 - 10000, 2 driver, 12000 and up lumen model. (21) DALI available from 4200 - 9000 lumen models. Two drivers required for 10000 lumen models and up. (22) Requires two drivers for 10000 lumens and above. (23) White tuning provides correlated color temperatures (CCT) between 3000K (warm) to 5000K (cool) or 2700K (warm) to 6500K (cool). Must be used in conjunction with W2A. Integrated options must be used in conjunction with the associated system and may not be compatible with other options or accessories. Please refer to the following: (F) Consult Marketplace Options - Lutron system pages for additional details and compatibility. Compatible only with driver series shown, and may require two or more drivers. Requires field commissioning to operate or dim. Contact Lutron at www.lutron.com

No. of Drivers	Options	Integrated Sensing Systems	Packaging	Accessories ⁽²⁹⁾
1=1 Driver 2=2 Drivers	PAF =Painted After Fabrication G1 =Gasket, Door Frame and Housing G2 =G1 plus Gasket between Lens and Door G3 =G1 and G2 plus Gasketing on Mounting Surface of Fixture Trims ^{(24), (25)}	[Blank] =No Sensor WLS (formerly WAB) =WaveLinX LITE Wireless Sensor, Occupancy w/ photocell, Independent & Networked ^{(26),(B)} WPS (formerly WAA) =WaveLinX PRO Wireless Sensor, Occupancy w/ photocell, Networked ^{(26),(A)} WLN =WaveLinX LITE Wireless Control Node, without sensor ^{(27),(B)} WPN =WaveLinX PRO Wireless Control Node, without sensor ^{(26),(A)}	U =Unit Pack PAL =Job Pack, out of carton PALC =Job Pack, in carton	EQ-CLIP-U =T-BAR Safety Earthquake Clips ⁽²⁸⁾ DF-24W-U =2' x 4' Drywall Frame Kit SK-24-WS =2' x 4' Shallow Surface Mount Kit SK-24-WT =2' x 4' Tall Surface Mount Kit
	Notes (24) Gasketing only available with aluminum door frame. (25) Gasketing minimum .125	Notes (26) WPS sensor and WPN node to be used with CD, HCD or W2A driver. (27) WLS sensor and WLN to be used with CD or HCD driver. Integrated options must be used in conjunction with the associated system and may not be compatible with other options or accessories. Please refer to the following: (A) Consult WaveLinX PRO system pages for additional details and compatibility. (B) Consult WaveLinX LITE system pages for additional details and compatibility.		Notes (28) An EQ Grid Clip is recommended for all 9/16" ceiling systems. (29) Accessories sold separately will be separately analyzed under domestic preference requirements. Consult factory for further information.

Product Specifications

Construction

- Rigid housing is die formed of code gauge prime cold rolled steel
- Full length die-formed stiffeners and unibody endplate for added strength
- Innovative design provides superior lens brightness, uniformity and visual comfort
- Unibody endplates are securely attached with interlocking tabs and screws
- Four auxiliary fixture end suspension points provided
- Endplates have integral Grid-lock feature for safety and convenience

Controls

- Standard with 0-10V dimming driver (10% standard, 1% optional)
- Integrated WaveLinX options provide wireless individual fixture control and enable code compliance, increased energy savings, grouping of fixtures, and connection to WaveLinX control systems
- DALI 2.0, Lutron, and step-dimming available

Electrical

- TM-21 life at 60,000 hours up to L88 and calculated L70 exceeds 162,000 hrs.
- Available in 3000K, 3500K, 4000K or 5000K with a minimum of 80 CRI
- Color accuracy ≤ 3 -Step MacAdam ellipse (SDCM)
- Drivers available in 120-277V and 347V
- Tunable white options available with Cooper Lighting Solutions' VividTune

Emergency Battery Pack Option

- 120V-277V integral emergency battery pack comes in 7-watts, 10-watt, or 14-watts
- Self-diagnostic emergency battery available in 10 or 14-watts (NFPA 101@ Life Safety Code®)
- Constant power to the LED system for controlled, predictable discharge
- Integrated test switch/indicator light visible from floor
- Min. 90-minute backup period for code compliance
- Integral emergency transfer relay available for generator equipped power systems

Frame/Optical Shielding

- Die formed, flat steel door with frosted #12 pattern acrylic prismatic lens
- Primary stocking skus come standard with robust .095 lens
- Other options available for maximum versatility
- Replacement lenses available, contact factory

Compliance

- IC rated for insulation contact
- cULus listed for damp locations
- RoHS compliant
- Tested to IESNA LM-79 and LM-80
- Stated life per TM21 standards
- Can be used for State of California Title 24 high efficacy luminaire

BABA Domestic Preference Compliance

- This Cooper product is manufactured in the US and meets the BABA cost of components rule. To verify a configured product with specific accessories and options meets BABA Domestic Preference Requirements; submit this catalog number to Cooper Lighting Quotation team for validation by our Engineering and Manufacturing teams. Our BABA designation is based on the minimum compliance requirement for BABA. Individual Government Agencies may have more stringent compliance standards. Please refer to the [DOMESTIC PREFERENCES](#) website or consult the CLS Domestic Preferences team for more information. Components shipped separately may be separately analyzed under domestic preference requirements.

Photometric Data

 View IES files

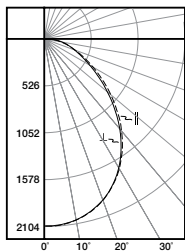

24GR-LD5-48-F1UNV-L835-CD1-U

Electronic Driver
 Linear LED 3500K
 Spacing criterion: (II) 1.19 x mounting height,
 (⊥) 1.18 x mounting height
 Lumens: 4821
 Input Watts: 37W
 Efficacy: 128.6 lm/W
 Test Report: 24GRLD5-48-F1-UNVL835-CD1-U.IES

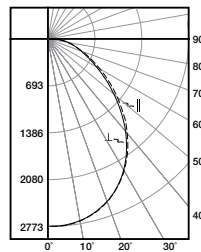

24GR-LD5-64-F1UNV-L835-CD1-U

Electronic Driver
 Linear LED 3500K
 Spacing criterion: (II) 1.19 x mounting height,
 (⊥) 1.18 x mounting height
 Lumens: 6462
 Input Watts: 48W
 Efficacy: 134.2 lm/W
 Test Report: 24GRLD5-64-F1-UNVL835-CD1-U.IES

Energy and Performance Data

Stock or MTO*	Catalog Logic	Delivered Lumens	Watts	Efficacy (lm/W)
MTO	24GR-LD5-30-F1-UNV-L835-CD1-U	3074	23.4	131
MTO	24GR-LD5-34-F1-UNV-L835-CD1-U	3459	26.7	129
Stock	24GR-LD5-38-F1-UNV-L835-CD1-U	3880	30.6	127
MTO	24GR-LD5-42-F1-UNV-L835-CD1-U	4294	34.6	124
Stock	24GR-LD5-48-F1-UNV-L835-CD1-U	4821	37.4	129
MTO	24GR-LD5-56-F1-UNV-L835-CD1-U	5618	45.1	124
Stock	24GR-LD5-64-F1-UNV-L835-CD1-U	6462	48.1	134
MTO	24GR-LD5-72-F1-UNV-L835-CD1-U	7257	56.0	129
MTO	24GR-LD5-85-F1-UNV-L835-CD1-U	8567	70.3	122
MTO	24GR-LD5-90-F1-UNV-L835-CD1-U	9092	69.1	132
MTO	24GR-LD5-100-F1-UNV-L835-CD2-U	10030	71.7	140
MTO	24GR-LD5-120-F1-UNV-L835-CD2-U	12260	90.1	136
MTO	24GR-LD5-130-F1-UNV-L835-CD2-U	13290	90.2	134
MTO	24GR-LD5-150-F1-UNV-L835-CD2-U	15340	120.3	128
MTO	24GR-LD5-180-F1-UNV-L835-CD2-U	18050	144.2	125

*Stocked in 3500K and 4000K others are MTO.

Lumen Maintenance

Ambient Temperature	TM-21 Lumen Maintenance (60,000 hours)	Theoretical L70 (Hours)
25°C	> 88%	> 162,000

Lens Table

Approximate Lumen Multiplier	
F1	1.0
F125	1.0
A125	1.01
A	1.01
A19/156	.975
FGW080	.85

CCT Table

Approximate Color Temperature Multiplier	
5000K	1.016
4000K	1.016
3500K	1.0
3000K	.982
2700K	.930

Shipping Data

Catalog No.	Wt.	Pallet
24GR-LD5-48	20 lbs.	28

Control Solutions

- WaveLinX LITE wireless
- WaveLinX PRO wireless
- WaveLinX CAT wired
- WaveLinX Wired



The GRLED with WaveLinX offers no-hassle lighting control with multiple luminaire level control solutions.



WaveLinX PRO is a wireless lighting control solution, for connected spaces, that significantly reduces a building's energy consumption. From a single floor to an entire campus, WaveLinX PRO connects more than lighting assets; it shares aggregated sensor data with the WaveLinX CORE platform and other building systems, so building owners can improve operations, spaces environment, and tenants' experience. WaveLinX PRO offers a rich portfolio of wireless devices, WaveLinX PRO-enabled luminaires, and an intuitive WaveLinX mobile app for office, education, warehouse, and parking garage applications.



WaveLinX LITE is a cost effective, wireless digital lighting control solution, with out-of-the-box functionality, that saves energy and meets code. It's designed for applications that require occupancy-based, daylighting, or manual light control. Customize installations for office, education, warehouse and parking garages using the secure, simple mobile app.

Integrated Sensor Coverage Pattern

TOP VIEW:

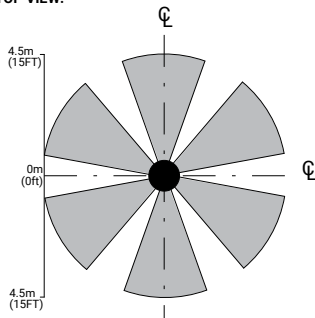

SIDE VIEW:

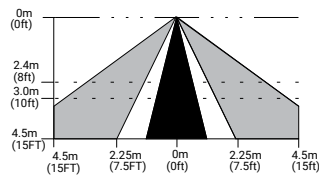

Note: Installation of integrated sensors within 3-ft (1m) of HVAC air vents is not recommended. The pattern shown is intended solely as a general guide and is not to scale.

With Integrated WaveLinX Sensor



With Integrated WaveLinX Node

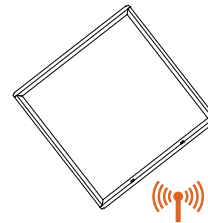

Add a hidden WaveLinX sensor node (WPN, WLN) to your space lighting design!

Allows to:

- Keeps luminaire aesthetics
- Connect fixtures without the realestate to include sensor option such as downlights
- Connect sealed fixtures without a standard sensor option such as products for clinical space.

Integrated Controls Options

Option	Out of the Box Functionality	Luminaire Level Lighting Control (LLC)	Automatic Dimming Photocell	Occupancy Sensing	CCT Control
WLS	X	X	X	X	
WLN		X			
WPS		X	X	X	X
WPN		X			X

Note: WaveLinX utilizes scenes to allow users to change an area's fixtures Correlated Color Temperature (CCT) and intensity using commissioned manual wireless wallstation scene control. To enable CCT adjustments through WaveLinX, include WPS or WPN devices in addition to VividTune or BioUp technologies for integrated fixture control.

Systems comparison chart

Cooper Lighting Solutions provides many lighting system solutions designed to satisfy code requirements and meet the unique needs of any project.



Luminaire with standalone sensor

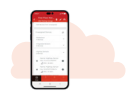

Standalone Spaces WaveLinX LITE



Standalone Spaces WaveLinX CAT



Networked Spaces WaveLinX PRO



Enterprise WaveLinX CORE

	Luminaire with standalone sensor	Standalone Spaces WaveLinX LITE	Standalone Spaces WaveLinX CAT	Networked Spaces WaveLinX PRO	Enterprise WaveLinX CORE
Occupancy	Yes	Yes	Yes	Yes	Yes
Daylighting	Yes	Yes	Yes	Yes	Yes
Wallstations	-	Yes	Yes	Yes	Yes
Gateways	-	-	-	1 WAC	300 WACs
Devices (MAX)	-	40 per Area (1120 per space)	40 per Area	200 per WAC2	32,500 per CORE Enterprise
Software	-	WaveLinX LITE Mobile App	WaveLinX CAT Mobile App	WaveLinX Mobile App	CORE
Areas	-	28 per Space	Unlimited	50 per WAC2	up to 3,000
Zones	-	16 per Area	16 per Area	16 per Area	up to 9,000
Scheduling	-	-	-	Local	Global
VividTune™	-	-	-	Yes	Yes
Plug-Load Control	-	Yes	Yes	Yes	Yes
Low-Voltage Power	-	-	Yes	Yes	Yes
Integration	-	-	-	-	BACnet, API
Dashboards	-	-	-	-	Energy, Occupancy
Configuration	-	Installer	Installer	Technician	Technician / IT



24GR LED with VividTune Tunable White

VividTune tunable white luminaires from Cooper Lighting Solutions deliver high-quality light in a broad range of continuously variable color temperatures and intensities. Create a dynamic environment by adjusting the ambient light warmer or cooler to influence mood, support the task at hand, or create a dramatic ambience. The ability to control correlated color temperature and intensity separately using simple controls is the next evolution of LED lighting for the commercial, educational, healthcare and hospitality space. The unparalleled flexibility and number of available lighting environments enable users to find the right light with tunable white.

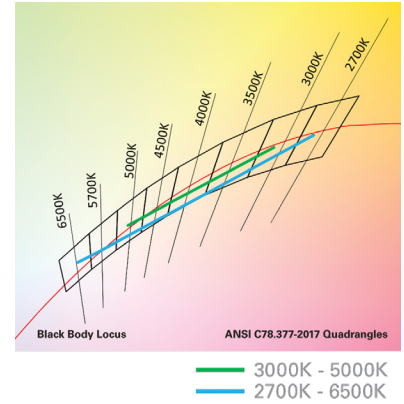

Performance Data*

Tunable White - Lumen Adjustment Factors (example only)				
CCT	3000K-5000K		2700K-6500K	
	80 CRI	90 CRI	80 CRI	90 CRI
2700K	-	-	0.923	0.789
3000K	0.950	0.783	0.949	0.820
3500K	1.006	0.855	0.983	0.861
4000K	1.056	0.923	1.004	0.888
4500K	1.066	0.939	1.022	0.911
5000K	1.066	0.939	1.036	0.929
6500K	-	-	1.051	0.955

2' x 4' GRLED - Example of Approximate Lumen Calculation			
	Standard Catalog #	VividTune 80 CRI Catalog #	VividTune 90 CRI Catalog #
CCT Setting	24GR-LD5-48-F1-UNV-L835-CD1-U	24GR-LD5-48-F1-UNV-L83050-W2A1-U	24GR-LD5-48-F1-UNV-L93050-W2A1-U
3000K	-	4582	3773
3500K	4821	4849	4122
4000K	-	5091	4451
4500K	-	5140	4529
5000K	-	5140	4529

Controlling VividTune Tunable White

VividTune luminaires make tunable white more accessible by using simple and familiar controls. From wall dimmers to wireless controls, VividTune tunable white luminaires are compatible with industry standard 0-10V dimming controls. A single 0-10V dimming input is used to control intensity (brightness) while a second 0-10V dimming input is used to adjust CCT. For suggested control configurations, go to www.cooperlighting.com for tunable white application guides.

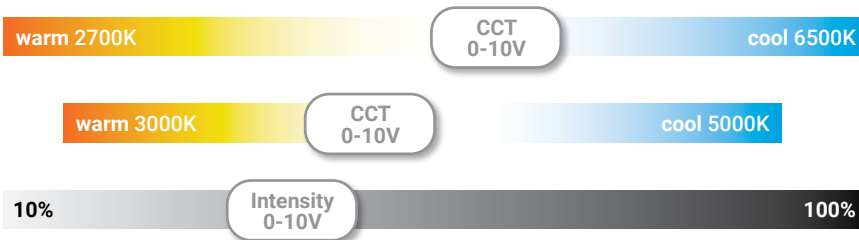

Example of Lumen Adjustment Calculation

24GR-LD5-48-F1-UNV-L83050-W2A1-U
at 80 CRI tuned to 3500K

$$\text{Adjusted Lumen} = \text{published lm} \times \text{adjusted lm factor}$$

$$\text{Adjusted Lumen} = 4821 \times 1.006$$

$$\text{Adjusted Lumen} = 4849 \text{ lm}$$

* Lumen adjustment factors are for reference and may be different for each product selected. Refer to IES files for actual performance data on each.