



# RSXF2 LED Floodlight



Catalog Number
Notes
Type

Hit the Tab key or mouse over the page to see all interactive elements.

## Specifications

EPA (ft <sup>2</sup> @45°):	0.9 ft <sup>2</sup> (0.08 m <sup>2</sup> )
Length:	28.3" (71.9 cm)
Width:	13.4" (34.0 cm)
Height:	3.0" (7.6 cm) Main Body 7.6" (19.3 cm) Arm
Weight:	33 lbs (15.0 kg)

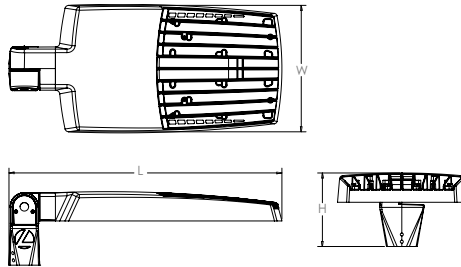

## Introduction

The new RSXF LED Flood family delivers maximum value by providing significant energy savings, long life and outstanding photometric performance at an affordable price. The RSXF2 delivers 11,000 to 44,000 lumens allowing it to replace 250W to 1000W HID floodlights.

The RSXF features an adjustable integral slipfitter that allows the luminaire to be mounted on a 2-3/8" OD tenon. Integral cover/wire box serves as an approved splice compartment allowing for fast, easy mounting and wiring without opening the electrical compartment. A yoke and other mounting configurations are available.



Items marked by a shaded background qualify for the Design Select program and ship in 15 days or less. To learn more about Design Select, visit [www.acuitybrands.com/designselect](http://www.acuitybrands.com/designselect). \*See ordering tree for details

ds Design Select options indicated by this color background.

## Ordering Information

**EXAMPLE: RSXF2 LED P4 40K WFL MVOLT IS DDBXD**

RSXF2 LED					
Series	Performance Package	Color Temperature	Distribution	Voltage	Mounting
RSXF2 LED	P1 P2 P3 P4 P5 P6 P7 <sup>1</sup> P8 <sup>1</sup>	30K 3000K 40K 4000K 50K 5000K	AWFD Area Wide Forward WFL Wide Flood MFL Medium Flood NFL Narrow Flood SP Spot NSP Narrow Spot	MVOLT (120V-277V) <sup>2</sup> HVOLT (347V-480V) <sup>3</sup> XVOLT (277V-480V) <sup>4</sup> <b>(use specific voltage for options as noted)</b> 120 <sup>5</sup> 277 <sup>5</sup> 208 <sup>5</sup> 347 <sup>5</sup> 240 <sup>5</sup> 480 <sup>5</sup>	IS Adjustable slipfitter (fits 2-3/8" OD tenon) <sup>6</sup> YKC63 Yoke with 16-3 SO cord, 3ft <sup>6</sup> AASP Adjustable tilt arm square pole mounting <sup>6</sup> AARP Adjustable tilt arm round pole mounting <sup>6</sup> AAWB Adjustable tilt arm with wall bracket <sup>6</sup> AAWSC Adjustable tilt arm wall bracket and surface conduit box <sup>6</sup>

Options		Finish
<p><b>Shipped Installed</b></p> <p>PE Photocontrol, button style<sup>7,8</sup></p> <p>PER7 Seven-wire twist-lock receptacle only (no controls)<sup>8,9,10</sup></p> <p>SF Single fuse (120, 277, 347)<sup>5</sup></p> <p>DF Double fuse (208, 240, 480)<sup>5</sup></p> <p>SPD20KV 20KV Surge pack (10KV standard)</p> <p>FAO Field adjustable output<sup>8</sup></p> <p>DMG 0-10V dimming extend out back of housing for external control (control ordered separate)<sup>8</sup></p> <p>DS Dual Switching<sup>8,11</sup></p>	<p><b>Shipped Installed</b></p> <p><b>*Standalone and Networked Sensors/Controls (factory default settings, see table page 9)</b></p> <p>NLTAIR2 PIRHN nLight AIR generation 2, with Networked, Bi-Level motion/ambient sensor<sup>8,12,13,14</sup></p> <p>BAA Buy America(n) Act and/or Build America Buy America Qualified</p> <p>CCE Coastal Construction<sup>15</sup></p> <p><b>Shipped Separately (requires some field assembly)</b></p> <p>FV Full Visor (360° around light aperture)<sup>16</sup></p> <p>UBV Upper/bottom visor<sup>16</sup></p> <p>BS Bird Spikes<sup>17</sup></p> <p><b>*Note: NLTAIR2 PIRHN with nLight Air can be used as a standalone or networked solution. Sensor coverage pattern is affected when luminaire is tilted.</b></p>	<p>DDBXD Dark Bronze</p> <p>DBLXD Black</p> <p>DNAXD Natural Aluminum</p> <p>DWHXD White</p> <p>DDBTXD Textured Dark Bronze</p> <p>DBLTXD Textured Black</p> <p>DNATXD Textured Natural Aluminum</p> <p>DWHGXD Textured White</p>



COMMERCIAL OUTDOOR

One Lithonia Way • Conyers, Georgia 30012 • Phone: 800-705-SERV (7378) • [www.acuitybrands.com](http://www.acuitybrands.com)  
© 2011-2025 Acuity Brands Lighting, Inc. All rights reserved.

Lithonia RSXF2 Flood LED  
Rev. 01/28/25  
Page 1 of 8

## Ordering Information

### Accessories

Ordered and shipped separately.

RSXF2FV (FINISH) U	Full visor (specify finish)
RSXF2UBV (FINISH) U	Upper/bottom visor (specify finish)
DLL127F 1.5 JU	Photocell - SSL twist-lock (120-277V) <sup>18</sup>
DLL347F 1.5 CUL JU	Photocell - SSL twist-lock (347V) <sup>18</sup>
DLL480F 1.5 CUL JU	Photocell - SSL twist-lock (480V) <sup>18</sup>
DSHORT SBK U	Shorting cap <sup>18</sup>

### NOTES

- 1 P7 and P8 not available with MFL optic.
- 2 MVOLT driver operates on any line voltage from 120-277V (50/60 Hz).
- 3 HVOLT driver operates on any line voltage from 347-480V (50/60 Hz).
- 4 XVOLT driver not available with P1. XVOLT driver operates on any line voltage from 277V-480V (50/60 Hz). XVOLT not available with fusing (SF or DF) and not available with PE.
- 5 Single fuse (SF) requires 120V, 277V or 347V. Double fuse (DF) requires 208V, 240V or 480V.
- 6 Maximum tilt is 90° above horizontal.
- 7 Requires MVOLT or 347V.
- 8 Two or more of the following options cannot be combined including PE, DMG, PER7, FAO, DS and NLTAIR2 PIRHN. (Exception: PE and FAO can be combined; also PE and DMG can be combined.)
- 9 Compatible with standard twist-lock photocells for dusk to dawn operation or advanced control nodes that provide 0-10V dimming signals. Wire 4/Wire 5 wired to dimming leads on driver. Wire6/Wire7 capped inside luminaire. Twistlock photocell ordered and shipped as a separate line item from Acuity Brands Controls. See accessories. Shorting Cap included.

- 10 For units with option PER7, the mounting must be restricted to +/- 45° from horizontal aim per ANSI C136.10-2010.
- 11 DS requires (2) separately switched circuits. DS provides 50/50 fixture operation via (2) different sets of leads using (2) drivers. DS only available with packages P5 and P6.
- 12 Must be ordered with PIRHN.
- 13 Requires MVOLT or HVOLT.
- 14 Must be ordered with NLTAIR2. For additional information on NLTAIR visit here.
- 15 CCE option not available with AASP, AARP, AAWB, AAWBSC, UBV, FV and BS.
- 16 It may be ordered as an accessory.
- 17 Must be ordered with fixture for factory pre-drilling.
- 18 Requires luminaire to be specified with PER7 option. Ordered and shipped as a separate line item from Acuity Brands Controls.

## External Shields



UBV Visor - Top Mounted



UBV Visor - Bottom Mounted



Full Visor - 360°

## Pole/Mounting Information

Accessories including bullhorns, cross arms and other adapters are available under the accessories tab at Lithonia's Outdoor Poles and Arms product page. Click here to visit [Accessories](#).

### HANDHOLE ORIENTATION

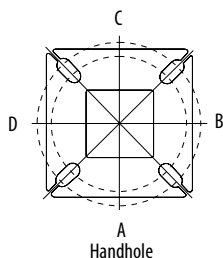

### Round Tenon Mount - Pole Top Slipfitters

Tenon O.D.	RSX Mounting	Single	2 @ 180	2 @ 90	3 @ 120	3 @ 90	4 @ 90
2 - 3/8"	AARP	AS3-5 190	AS3-5 280	AS3-5 290	AS3-5 320	AS3-5 390	AS3-5 490
2 - 7/8"	AARP	AST25-190	AST25-280	AST25-290	AST25-320	AST25-390	AST25-490
4"	AARP	AST35-190	AST35-280	AST35-290	AST35-320	AST35-390	AST35-490

### Drill Side Location by Configuration Type

Drilling Template	Mounting Option	Single	2 @ 180	2 @ 90	3 @ 120	3 @ 90	4 @ 90
	Head Location	Side B	Side B & D	Side B & C	Round Pole Only	Side B, C & D	Side A, B, C & D
#8	Drill Nomenclature	DM19AS	DM28AS	DM29AS	DM32AS	DM39AS	DM49AS

### Minimum Size Pole by Mounting and Configuration Type

Drilling Template	Mounting Option	Single	2 @ 180	2 @ 90	3 @ 120	3 @ 90	4 @ 90
AASP	Square Pole (min. size)	3"	3.5"	3.5"	---	3.5"	3.5"
AARP	Round Pole (min. size DIA.)	3"	3"	3.2"	3"	3.2"	3.2"

### RSX POLE DRILLING

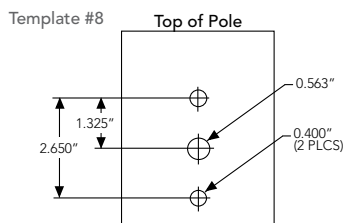

### RSXF ADJUSTABLE ARM

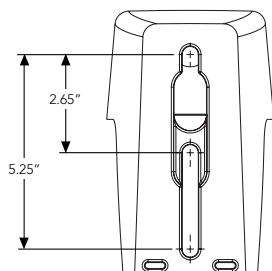

### RSXF2 - Luminaire EPA

\*Includes luminaire and integral mounting arm. Other tenons, arms, brackets or other accessories are not included in this EPA data.

Fixture Quantity & Mounting Configuration	Tilt	EPA (ft <sup>2</sup> )								
		Single	2 @ 90	2 @ 180	3 @ 90	3 @ 120	4 @ 90	2 Side by Side	3 Side by Side	4 Side by Side
IS - Integral Slipfitter YK - Yoke AASP/AARP - Adjustable Arm Square/Round Pole	0°	0.69	1.22	1.27	1.8	1.61	2.39	1.37	2.06	2.74
	10°	0.53	1.06	1.05	1.58	1.37	2.08	1.06	1.59	2.12
	20°	0.52	1.02	1.03	1.52	1.33	2.02	1.03	1.55	2.07
	30°	0.64	1.11	1.18	1.63	1.45	2.21	1.27	1.91	2.54
	40°	0.81	1.21	1.35	1.74	1.65	2.39	1.62	2.43	3.23
	45°	0.91	1.25	1.5	1.81	1.75	2.48	1.82	2.73	3.64
	50°	1.34	1.83	2.17	2.61	2.56	3.62	2.68	4.02	5.36
	60°	2.2	2.97	3.57	4.24	4.17	5.89	4.41	6.61	8.82
	70°	2.86	4.13	4.7	5.89	5.71	8.21	5.71	8.57	11.42
	80°	3.4	5.13	5.67	7.34	7.09	10.21	6.79	10.19	13.59
90°	3.85	5.96	6.55	8.58	8.31	11.88	7.7	11.56	15.41	



Isofootcandle plots for the RSXF2 LED P6 40K. Distances are in units of mounting height (30').

**LEGEND**

- 0.1 fc
- 0.5 fc
- 1.0 fc

**Luminaires tilted at 45°**

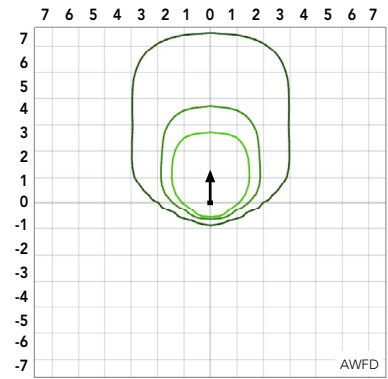
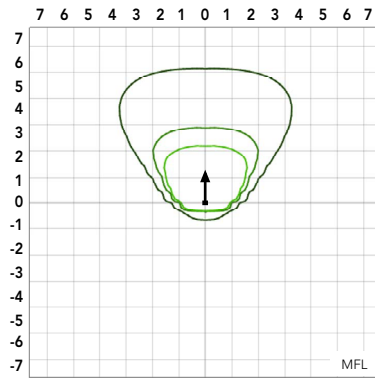
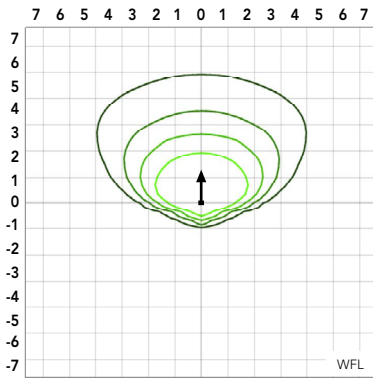

**Luminaires tilted at 0°**

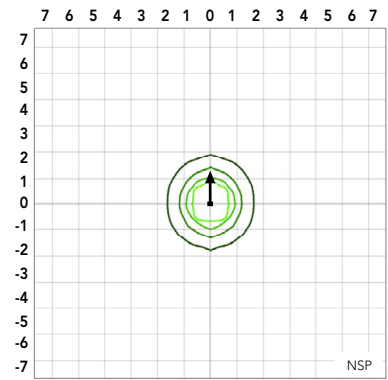
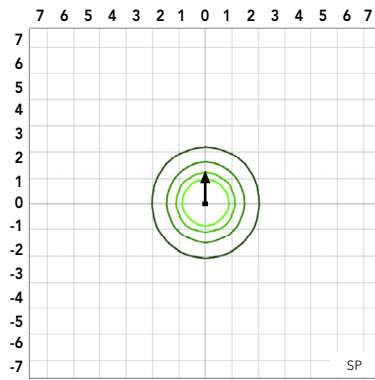
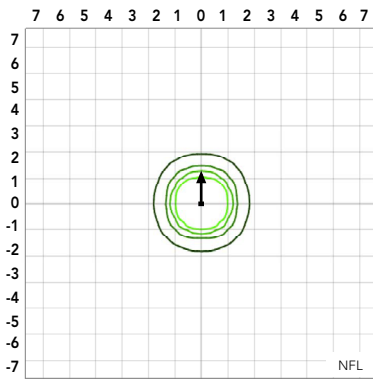

## Performance Data

### Lumen Ambient Temperature (LAT) Multipliers

Use these factors to determine relative lumen output for average ambient temperatures from 0-50°C (32-122°F).

Ambient	Ambient	Lumen Multiplier
0°C	32°F	1.05
5°C	41°F	1.04
10°C	50°F	1.03
15°C	59°F	1.02
20°C	68°F	1.01
25°C	77°F	1.00
30°C	86°F	0.99
35°C	95°F	0.98
40°C	104°F	0.97
45°C	113°F	0.96
50°C	122°F	0.95

### Electrical Load

Performance Package	System Watts (W)	Current (A)					
		120V	208V	240V	277V	347V	480V
P1	71W	0.59	0.34	0.30	0.26	0.20	0.15
P2	111W	0.93	0.53	0.46	0.40	0.32	0.23
P3	147W	1.23	0.70	0.61	0.53	0.42	0.31
P4	187W	1.55	0.90	0.78	0.68	0.53	0.38
P5	210W	1.75	1.01	0.87	0.76	0.60	0.44
P6	244W	2.03	1.17	1.01	0.88	0.70	0.51
P7	274W	2.49	1.41	1.22	1.06	0.85	0.61
P8	326W	2.96	1.68	1.45	1.26	1.01	0.73

### Projected LED Lumen Maintenance

Operating Hours	50,000	75,000	100,000
Lumen Maintenance Factor	>0.97	>0.95	>0.92

Values calculated according to IESNA TM-21-11 methodology and valid up to 40°C.

### Lumen Output

Lumen values are from photometric tests performed in accordance with IESNA LM-79-08. Data is considered to be representative of the configurations shown, within the tolerances allowed by Lighting Facts. Contact factory for performance data on any configurations not shown here.

Performance Package	System Watts	Distribution Type	Field Angle		Beam Angle		30K (3000K, 70 CRI)			40K (4000K, 70 CRI)			50K (5000K, 70 CRI)		
			°H	°V	°H	°V	Lumens	LPW	Max CD	Lumens	LPW	Max CD	Lumens	LPW	Max CD
P1	71W	AWFD	119	120	69	41	9,663	136	7,915	10,616	150	8,696	10,616	150	8,696
		WFL	133	129	116	80	9,467	133	4,031	10,401	146	4,428	10,401	146	4,428
		MFL	105	110	91	96	9,873	139	4,482	10,847	153	4,924	10,847	153	4,924
		NFL	78	79	44	45	9,529	134	14,090	10,469	147	15,480	10,469	147	15,480
		SP	48	48	27	27	9,223	130	29,378	10,133	143	32,277	10,133	143	32,277
P2	111W	AWFD	119	120	69	41	15,094	136	12,364	16,584	149	13,584	16,584	149	13,584
		WFL	133	129	116	80	14,788	133	6,296	16,248	146	6,918	16,248	146	6,918
		MFL	105	110	91	96	15,422	139	7,001	16,944	153	7,692	16,944	153	7,692
		NFL	78	79	44	45	14,885	134	22,010	16,354	147	24,182	16,354	147	24,182
		SP	48	48	27	27	14,407	130	45,891	15,828	143	50,418	15,828	143	50,418
P3	147W	AWFD	119	120	69	41	19,007	129	15,569	20,883	142	17,106	20,883	142	17,106
		WFL	133	129	116	80	18,622	127	7,928	20,460	139	8,711	20,460	139	8,711
		MFL	105	110	91	96	19,420	132	8,816	21,337	145	9,687	21,337	145	9,687
		NFL	78	79	44	45	18,744	128	27,716	20,594	140	30,451	20,594	140	30,451
		SP	48	48	27	27	18,142	123	57,788	19,932	136	63,490	19,932	136	63,490
P4	187W	AWFD	119	120	69	41	22,974	123	18,819	25,241	135	20,676	25,241	135	20,676
		WFL	133	129	116	80	22,509	120	9,583	24,730	132	10,529	24,730	132	10,529
		MFL	105	110	91	96	23,474	126	10,657	25,790	138	11,708	25,790	138	11,708
		NFL	78	79	44	45	22,656	121	33,500	24,892	133	36,807	24,892	133	36,807
		SP	48	48	27	27	21,928	117	69,848	24,092	129	76,741	24,092	129	76,741
P5	210W	AWFD	119	120	69	41	22,314	119	117,820	24,516	131	129,446	24,516	131	129,446
		WFL	133	129	116	80	24,722	118	20,251	26,786	128	21,941	26,786	128	21,941
		MFL	105	110	91	96	24,222	115	10,312	26,612	127	11,330	26,612	127	11,330
		NFL	78	79	44	45	25,260	120	11,468	27,752	132	12,599	27,752	132	12,599
		SP	48	48	27	27	24,380	116	36,050	26,786	128	39,607	26,786	128	39,607
P6	244W	AWFD	119	120	69	41	23,597	112	75,164	25,925	123	82,580	25,925	123	82,580
		WFL	133	129	116	80	24,012	114	126,785	26,381	126	139,294	26,381	126	139,294
		MFL	105	110	91	96	27,637	113	22,638	30,364	124	24,872	30,364	124	24,872
		NFL	78	79	44	45	27,077	111	11,528	29,749	122	12,666	29,749	122	12,666
		SP	48	48	27	27	28,237	116	12,819	31,024	127	14,085	31,024	127	14,085
P7	274W	AWFD	119	120	69	41	27,254	112	40,299	29,944	123	44,277	29,944	123	44,277
		WFL	133	129	116	80	26,378	108	84,023	28,981	119	92,314	28,981	119	92,314
		MFL	105	110	91	96	26,842	110	141,728	29,491	121	155,715	29,491	121	155,715
		NFL	78	79	44	45	27,254	112	40,299	29,944	123	44,277	29,944	123	44,277
		SP	48	48	27	27	26,378	108	84,023	28,981	119	92,314	28,981	119	92,314
P8	326W	AWFD	119	120	69	41	35,876	131	29,386	39,323	144	32,210	39,323	144	32,210
		WFL	133	129	116	80	35,120	128	14,952	38,495	140	16,388	38,495	140	16,388
		MFL	105	110	91	96	35,328	129	52,236	38,722	141	57,255	38,722	141	57,255
		NFL	78	79	44	45	34,410	126	109,608	37,716	138	120,140	37,716	138	120,140
		SP	48	48	27	27	34,813	127	183,819	38,158	139	201,481	38,158	139	201,481



## Dimensions

### RSXF2 with Adjustable Slipfitter (IS)

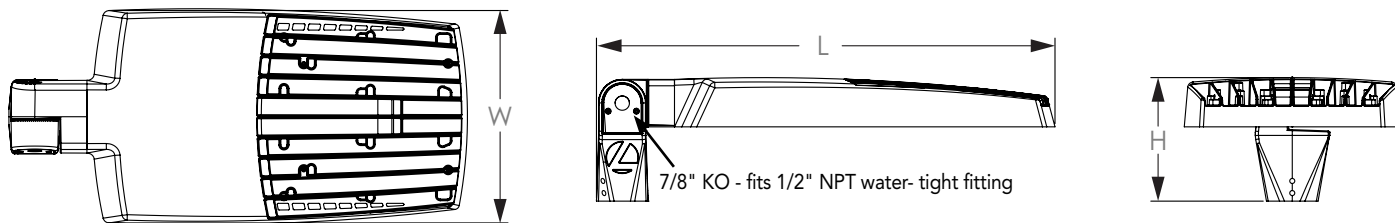

Length: 28.3" (71.9 cm)  
 Width: 13.4" (34.0 cm)  
 Height: 3.0" (7.6 cm) Main Body  
 7.6" (19.3 cm) Arm  
 Weight: 33 lbs (15.0 kg)

### RSXF2 with Yoke (YKC63)

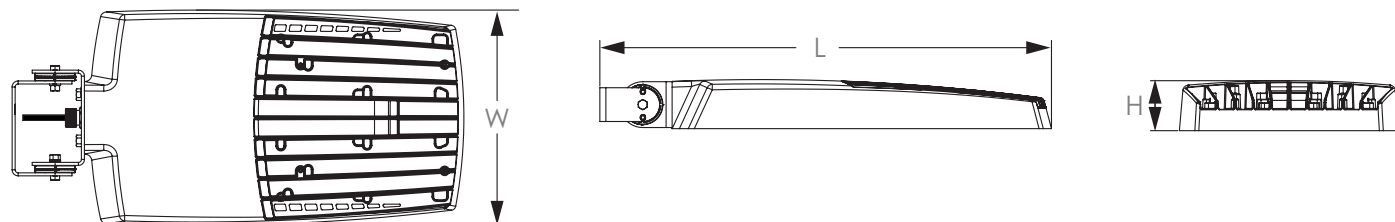

Length: 28.3" (71.9 cm)  
 Width: 3.4" (34.0 cm)  
 Height: 3.0" (7.6 cm) Main Body  
 Weight: 31 lbs (14.1 kg)

### Yoke (YK) Mounting Detail

**Note:** Mounting hole pattern is in-line with center of luminaire

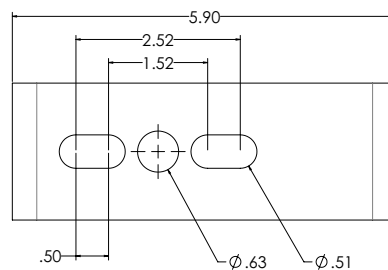

## Dimensions

### RSXF2 with Adjustable Tilt Arm - Square or Round Pole (AASP or AARP)

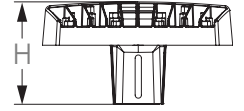
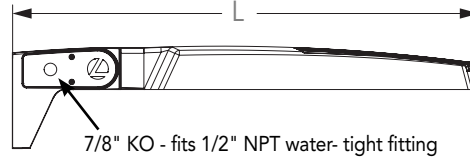
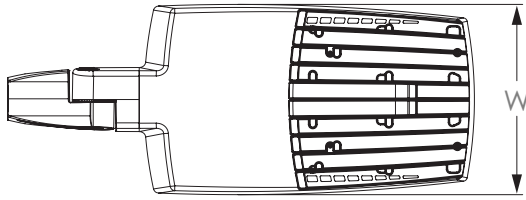

Length: 32.8" (83.3 cm) **AASP**  
 33.8" (85.9 cm) **AARP**  
 Width: 13.4" (34.0 cm)  
 Height: 3.0" (7.6 cm) Main Body  
 7.2" (18.2 cm) Arm  
 Weight: 25 lbs (11.3 kg) **AASP**  
 27 lbs (12.2 kg) **AARP**

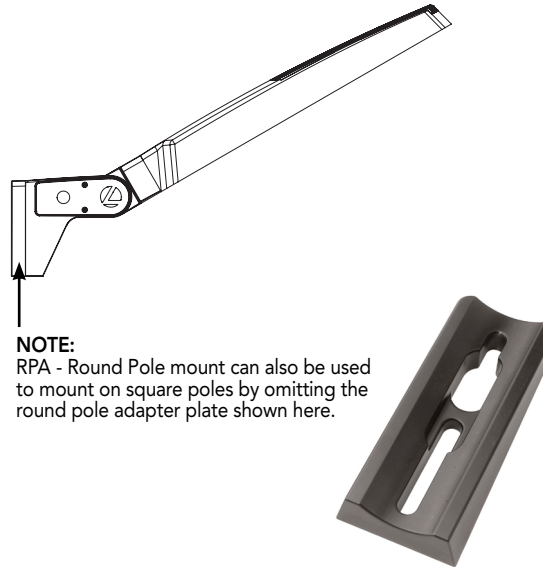

**NOTE:**  
 RPA - Round Pole mount can also be used to mount on square poles by omitting the round pole adapter plate shown here.

#### Notes

AASP: Requires 3.0" min. square pole for 1 at 90°. Requires 3.5" min. square pole for mounting 2, 3, 4 at 90°.

AARP: Requires 3.2" min. dia. round pole for 2, 3, 4 at 90°. Requires 3.0" min. dia. round pole for mounting 1 at 90°, 2 at 180°, 3 at 120°.

### RSXF2 with Adjustable Tilt Arm with Wall Bracket (AAWB)

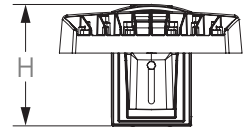
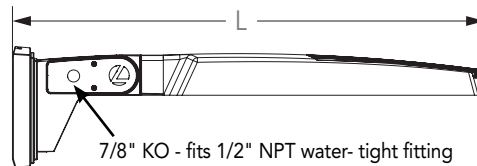
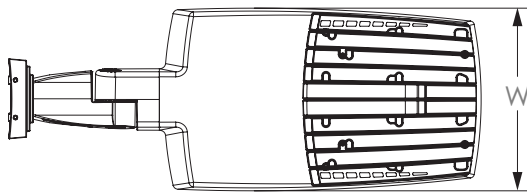

Length: 34.7" (88.1 cm)  
 Width: 13.4" (34.0 cm)  
 Height: 3.0" (7.6 cm) Main Body  
 8.9" (22.6 cm) Arm  
 Weight: 36 lbs (16.3 kg)

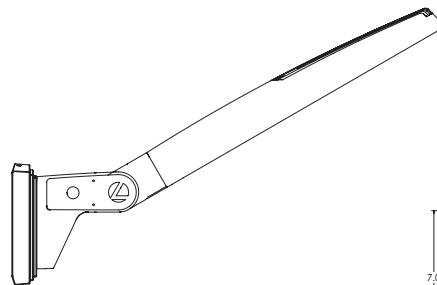

#### Wall Bracket (WBA) Mounting Detail

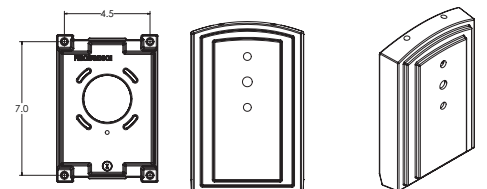

## Dimensions

### RSXF2 with Adjustable Tilt Arm with Wall Bracket and Surface Conduit Box (AAWSC)

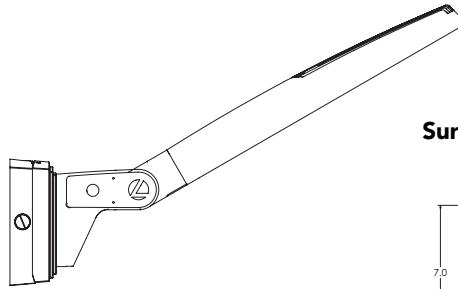
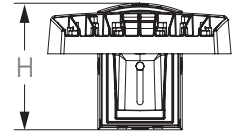
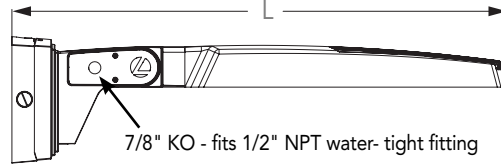
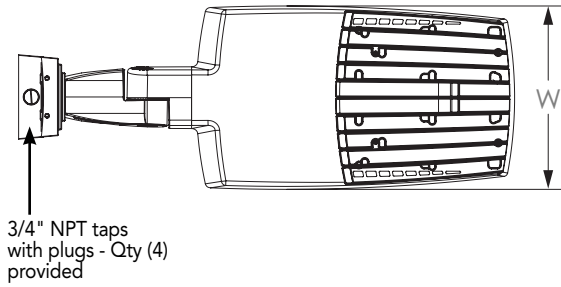

### Surface Conduit Box (SCB) Mounting Detail

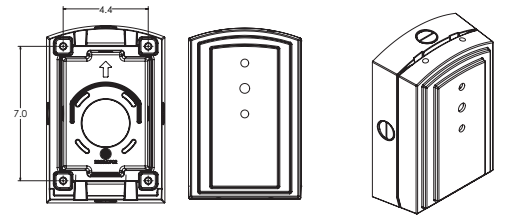

Length: 36.2" (91.9 cm)  
 Width: 13.4" (4.0 cm)  
 Height: 3.0" (7.6 cm) Main Body  
           9.2" (23.4 cm) Arm  
 Weight: 39 lbs (17.7 kg)

# nLight Control - Sensor Coverage and Settings

## PIRHN nLight Sensor Coverage Pattern

### nLight PIRHN

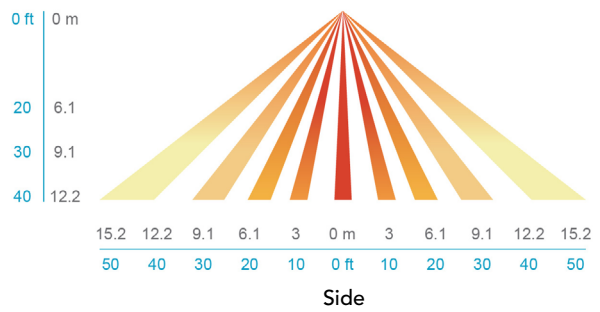
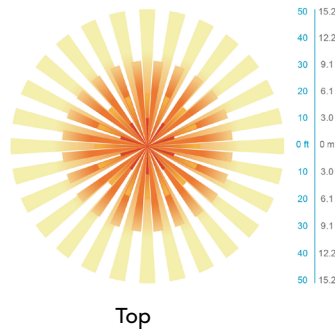
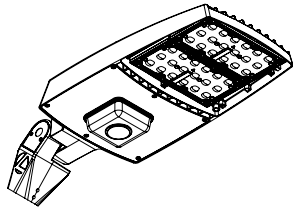

Motion Sensor Default Settings - Option PIRHN						
Option	Dimmed State (unoccupied)	High Level (when occupied)	Photocell Operation	Dwell Time (occupancy time delay)	Ramp-up Time (from unoccupied to occupied)	Ramp-down Time (from occupied to unoccupied)
NLTAIR2 PIRHN	Approx. 30% Output	100% Output	Enabled @ 1.5FC	7.5 minutes	3 seconds	5 minutes

\*Note: PIRHN default settings including photocell set-point, high/low dim rates, and occupancy sensor time delay are all configurable using the Clarity Pro App.

## FEATURES & SPECIFICATIONS

### INTENDED USE

The RSX LED flood family is designed to provide a long-lasting, energy-efficient solution for the one-for-one replacement of existing metal halide or high pressure sodium lighting. The RSXF1 delivers 11,000 to 44,000 lumens and is ideal for replacing 250W to 1000W HID floodlights in parking lots and other area lighting applications.

### CONSTRUCTION

The RSX LED flood luminaire features a rugged die-cast aluminum main body that uses heat-dissipating fins and flow-through venting to provide optimal thermal management that both enhances LED performance and extends component life. Integral adjustable slipfitter mounts on a 2 3/8" OD tenon. The adjustable slipfitter has an integral junction box for easy installation. The light engines and housing are sealed against moisture and environmental contaminants to IP66. The low-profile design results in a low EPA, allowing pole optimization. Vibration rated per ANSI 136.31: RSXF and mountings rated for 3G vibration include IS, YK, AASP and AARP. RSXF and mountings rated for 1.5G vibration include AAWB and AAWSC.

### FINISH

Exterior parts are protected by a zinc-infused Super Durable TGIC thermoset powder coat finish that provides superior resistance to corrosion and weathering. A tightly controlled multi-stage process ensures superior adhesion as well as a minimum finish thickness of 3 mils. The result is a high-quality finish that is warranted not to crack or peel.

### COASTAL CONSTRUCTION (CCE)

Optional corrosion resistant construction is engineered with added corrosion protection in materials and/or pre-treatment of base material under super durable paint. Provides additional corrosion protection for applications near coastal areas. Finish is salt spray tested to over 5,000 hours per ASTM B117 with scribe rating of 10. Additional lead-times apply.

### OPTICS

Precision acrylic refractive lenses are engineered for superior application efficiency, distributing the light to where it is needed most. Available in short and wide pattern distributions including Wide Flood, Medium Flood, Narrow Flood, Spot, Narrow Spot and an Area Wide/Forward distribution pattern featuring a strong forward throw reach that is ideal for lighting large areas from the perimeter.

### ELECTRICAL

Light engine(s) configurations consist of high-efficacy LEDs mounted on metal-core circuit boards and aluminum heat sinks to maximize heat dissipation. Light engines are IP66 rated. LED lumen maintenance is >L92/100,000 hours. CCT's of 3000K, 4000K and 5000K (minimum 70 CRI) are available. Fixtures ship standard with 0-10v dimming driver. Class 1 electronic drivers ensure system power factor >90% and THD <20%. Easily serviceable 10kV surge protection device meets a minimum Category C Low operation (per ANSI/IEEE C62.41.2).

### STANDARD CONTROLS

The RSX LED flood luminaire has a wide assortment of control options. Dusk to dawn controls include MVOLT and 347V button-type photocells and NEMA twist-lock photocell receptacles.

### nLIGHT AIR CONTROLS

The RSXF LED flood luminaire is also available with nLight® AIR which can be used for simple motion occupancy dimming or for the ultimate in wireless control. This powerful controls platform provides out-of-the-box basic motion sensing with photocontrol functionality and is suitable for mounting heights up to 40 feet. No commissioning is required when using factory default settings that provide basic stand-alone motion occupancy dimming that is switched on and off with a built-in photocell. See chart above for motion sensor default out-of-box settings. For more advanced wireless functionality, such as group dimming, nLight AIR can be commissioned using a smartphone and the easy-to-use CLAIRITY app. nLight AIR equipped luminaires can be grouped, resulting in motion sensor and photocell group response without the need for additional equipment. Scheduled dimming with motion sensor over-ride can be achieved when used with the nLight Eclipse. Additional information about nLight Air can be found [here](#).

### INSTALLATION

The integral "IS" mount offers an adjustable slipfitter that mounts on a 2 3/8" OD tenon. The adjustable slipfitter has an integral junction box and offers easy installation, wiring and precision distribution pattern aiming. A steel yoke mount is also available and includes a water-tight cord grip and cord. Additional mountings are available including an adjustable tilt arm for direct-to-pole and wall and a surface conduit box for wall mount applications. All mountings are adjustable in 5° increments. RSXF is not rated for tilting above 90° or mounting within 4 feet of ground. Can be tilted up to 90° above horizontal.

### LISTINGS

CSA Certified to meet U.S. and Canadian standards. Suitable for wet locations. DesignLights Consortium® (DLC) Premium qualified product and DLC qualified product. Not all versions of this product may be DLC Premium qualified or DLC qualified. Please check the DLC Qualified Products List at [www.designlights.org/QPL](http://www.designlights.org/QPL) to confirm which versions are qualified. International Dark-Sky Association (IDA) Fixture Seal of Approval (FSA) is available for all products on this page utilizing 3000K color temperature only. U.S Patent No. D882,156S

### GOVERNMENT PROCUREMENT

BAA – Buy America(n) Act: Product with the BAA option qualifies as a domestic end product under the Buy American Act as implemented in the FAR and DFARS. Product with the BAA option also qualifies as manufactured in the United States under DOT Buy America regulations. BABA – Build America Buy America: Product with the BAA option also qualifies as produced in the United States under the definitions of the Build America, Buy America Act. Please refer to [www.acuitybrands.com/buy-american](http://www.acuitybrands.com/buy-american) for additional information.

### WARRANTY

5-year limited warranty. This is the only warranty provided and no other statements in this specification sheet create any warranty of any kind. All other express and implied warranties are disclaimed. Complete warranty terms located at: [www.acuitybrands.com/support/warranty/terms-and-conditions](http://www.acuitybrands.com/support/warranty/terms-and-conditions)

**Note:** Actual performance may differ as a result of end-user environment and application. All values are design or typical values, measured under laboratory conditions at 25 °C. Specifications subject to change without notice.



COMMERCIAL OUTDOOR

One Lithonia Way • Conyers, Georgia 30012 • Phone: 800-705-SERV (7378) • [www.acuitybrands.com](http://www.acuitybrands.com)  
© 2011-2025 Acuity Brands Lighting, Inc. All rights reserved.

Lithonia RSXF2 Flood LED  
Rev. 01/28/25  
Page 8 of 8