

LEDVANCE Luminaires

DUAL SELECTABLE RT DOWNLIGHT

PERFORMANCE CLASS

Application

The LEDVANCE Performance Class Dual Selectable RT Downlight luminaires are offered in 4", 6", 8" and 10" sizes and provide high performing light optimized for both new construction and retrofit applications where pin-based compact fluorescent lamps have previously been used. Installation is done quickly and easily in most standard frames. The CCT and lumen selectable switches on the base of the fixture allow for customizable light color temperature and adjustable lumen output, offering up to 41% energy savings when compared to traditional technologies. The luminaires are emergency battery back-up ready.

Benefits and Features

- Spinning aluminum construction
- CCT selectable light enabled through the switch located on the base of the product (4 light colors in the same product)
- Lumen selectable enabled through the switch located on the base of the product (3 lumen levels in the same product)
- Emergency Battery Backup Ready (field installable)
- Wet Rated
- Trim extenders available as accessories
- Up to 91 LPW
- CRI >90
- Uniform, glare free illumination
- Energy savings up to 41%

Electrical

- 120-277V_{AC}/120-347V_{AC}
- Power Factor >0.9
- THD <20%
- 0-10V dimmable

Rated Life

- 50,000 hours (L₇₀)

Warranty

- 5-year
- NLB Trusted Warranty Program

Operating Temperature

- -4°F to +104°F (-20°C to +40°C)



Wattage Comparison

Traditional Source	Traditional System Wattage	LED System Wattage	Energy Savings
Fluorescent	8/11/14W	7/8/9W	Up to 36%
Fluorescent	8/14/15W	7/9/11W	Up to 26%
Fluorescent	15/23/27W	14/18/24W	Up to 22%
Fluorescent	2x17/2x19/2x23W	25/29/35W	Up to 24%
Fluorescent	2x23/2x24/2x27W	32/37/43W	Up to 23%
Fluorescent	8/11/14W	7/9/12W	Up to 14%
Fluorescent	15/23/27W	10/18/23W	Up to 15%
Fluorescent	27/2x17/2x23W	20/28/34W	Up to 26%
Fluorescent	2x15/2x23/2x27W	12/16/22W	Up to 41%

Certifications and Listings

- cETLus
- RoHS
- FCC
- ENERGY STAR®
- T24
- TAA

Installation

Installation performed as a stand-alone kit (without frame) is recommended for hard ceiling. Installation of a recessed incandescent frame is recommended for tiled ceiling application for proper support of the retrofit kit.



Catalog #	Type
Project	
Comments	
Prepared by	

Ordering Guide

RT	XX	5A	SXXXX	XXX	D	9	XX	XX	TAA
Product Name	Size	Generation	Selectable lumens	Voltage	Dimming	CRI	Color Temp	Color	TAA
RT = LED	4 = 4"	5A = Downlight	700 = 580/670/750lm	UNV = 120-277V	D = 1-10V	9 = >90	27 = 2700K	WH = White	AA = Assembled in a TAA compliant country
Downlight	6 = 6"	Generation	900 = 600/750/950lm	UNH = 120-347V	dimmable		SC8 = Selectable		
	8 = 8"		1000 = 600/800/1000lm				3000, 3500,		
	10 = 10"		2000 = 900/1600/2000lm				4000, 5000K or		
			2000 = 1000/1500/2000lm				2700, 3000,		
			2000 = 1100/1500/2000lm				3500, 4000		
			3000 = 1850/2500/3000lm						
			3300 = 2400/2800/3300lm						
			4000 = 3000/3500/4000lm						

Ordering Information

Item Number	Ordering Abbreviation	Power (W)	Dimming	Traditional Replacement (W)	Input Voltage (V)	Average Life (hrs)	CCT	Typical Lumens (lm)	CRI	Power Factor	Bulb Finish	IC Rated	Case Qty	ENERGY STAR®	T24
62805	RT45AS700UNVD9SC8WHTAA	7/8/9	0-10V	8/11/14	120-277	50,000	3000/3500/4000/5000K	580/670/750	>90	>90	Frosted	Yes	4	Yes	Yes
62807	RT65AS900UNVD9SC8WHTAA	7/9/11	0-10V	8/14/15	120-277	50,000	3000/3500/4000/5000K	600/750/950	>90	>90	Frosted	Yes	4	Yes	Yes
62808	RT65AS2000UNVD9SC8WHTAA	14/18/24	0-10V	15/23/27	120-277	50,000	3000/3500/4000/5000K	1100/1500/2000	>90	>90	Frosted	No	4	Yes	Yes
62809	RT85AS2000UNVD9SC8WHTAA	12/16/22	0-10V	2x15/2x23/2x27	120-277	50,000	3000/3500/4000/5000K	1000/1500/2000	>90	>90	Frosted	No	4	Yes	Yes
62810	RT85AS3300UNVD9SC8WHTAA	25/29/35	0-10V	2x17/2x19/2x23	120-277	50,000	3000/3500/4000/5000K	2400/2800/3300	>90	>90	Frosted	No	4	Yes	Yes
62811	RT105AS4000UNVD9SC8WHTAA	32/37/43	0-10V	2x23/2x24/2x27	120-277	50,000	3000/3500/4000/5000K	3000/3500/4000	>90	>90	Frosted	No	4	Yes	Yes
62824	RT45AS1000UNH9SC8WH	7/9/12	0-10V	8/11/14	120-347	50,000	2700/3000/3500/4000K	600/800/1000	>90	>90	Frosted	Yes	4	Yes	Yes
62825	RT65AS2000UNH9SC8WH	10/18/23	0-10V	15/23/27	120-347	50,000	2700/3000/3500/4000K	900/1600/2000	>90	>90	Frosted	No	4	Yes	Yes
62826	RT85AS3000UNH9SC8WH	20/28/34	0-10V	27/2x17/2x23	120-347	50,000	2700/3000/3500/4000K	1850/2500/3000	>90	>90	Frosted	No	4	Yes	Yes

Physical Information

Product Description	(A) Height (in)	(B) Diameter (in)
RT4	3.65"	5.51"
RT6	3.98"	7.36"
RT8	4.35"	9.45"
RT10	4.37"	11.26"

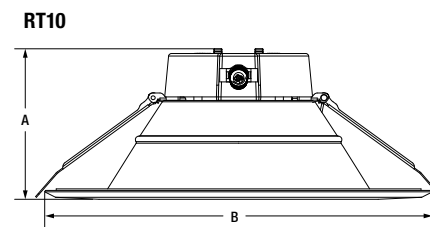
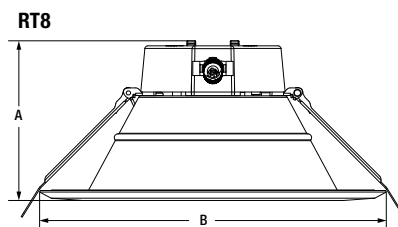
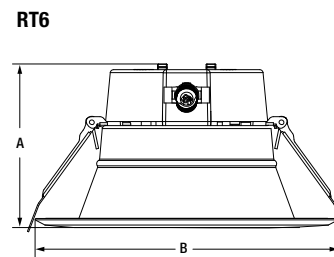
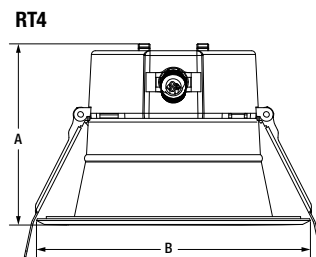

Photometric Data

RT45AS700UNVD9SC8WHTAA

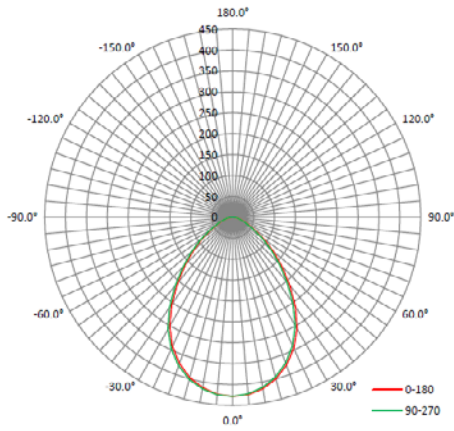

RT45AS700UNVD927WHTAA

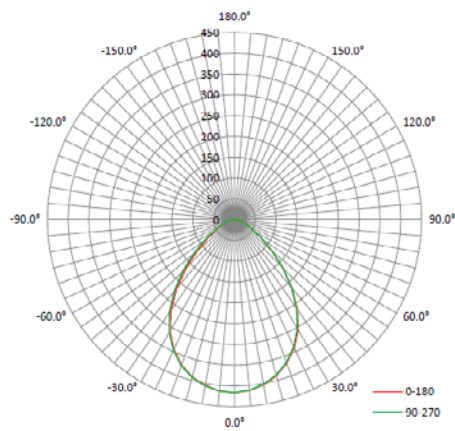

RT45AS1000UNH9SC8WH

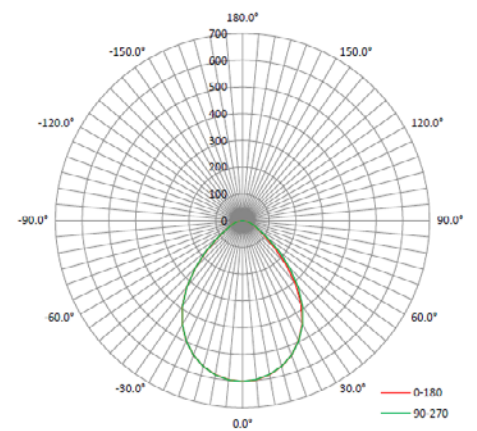

RT65AS900UNVD9SC8WHTAA

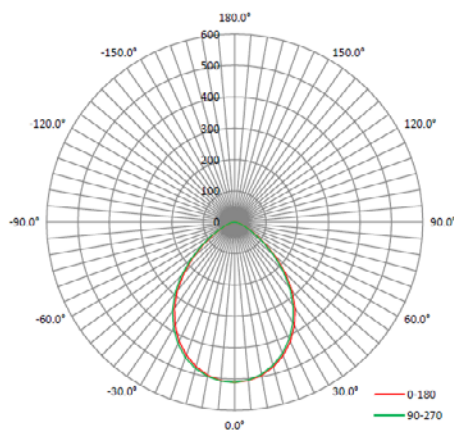

RT65AS900UNVD927WHTAA

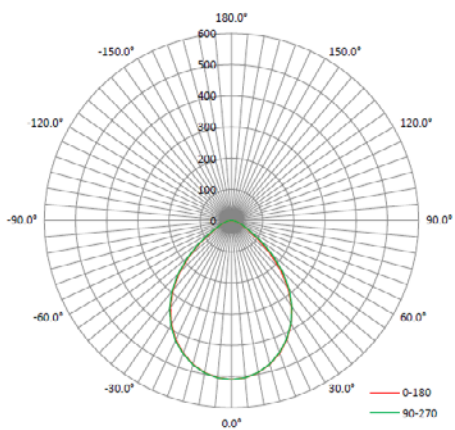

RT65AS2000UNH9SC8WH

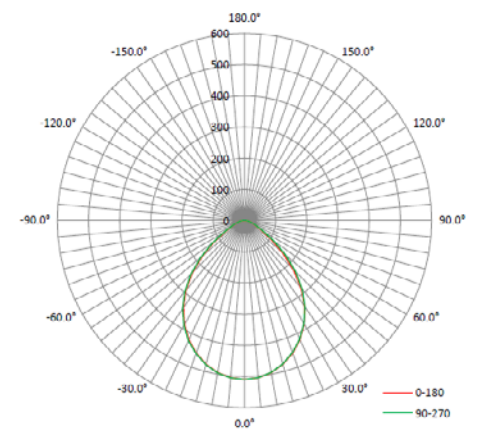

RT65AS2000UNVD9SC8WHTAA

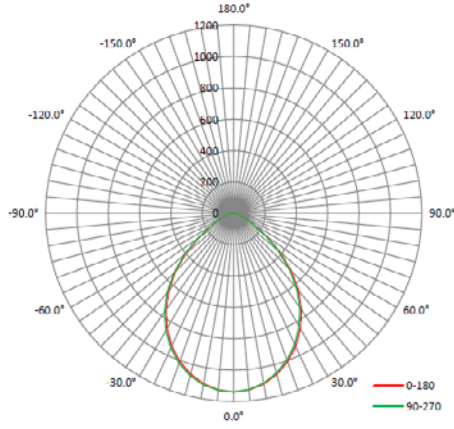

RT85AS3000UNH9SC8WH

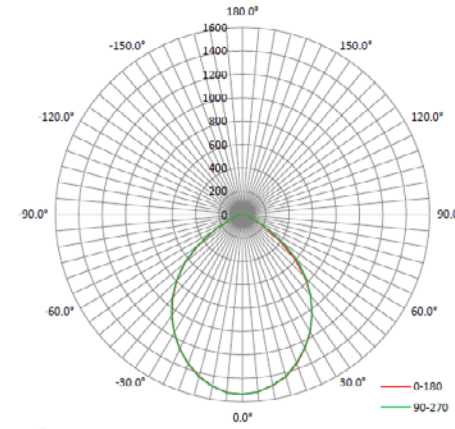

RT85AS3300UNVD9SC8WHTAA

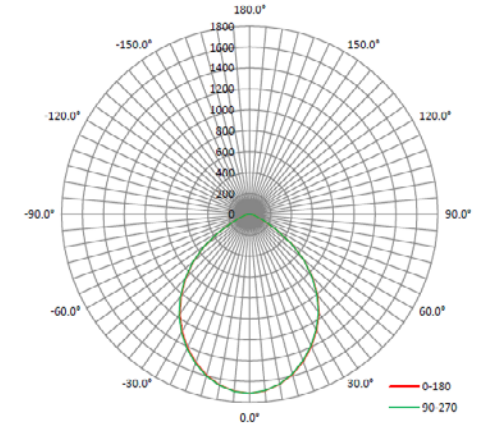

RT105AS4000UNVD9SC8WHTAA

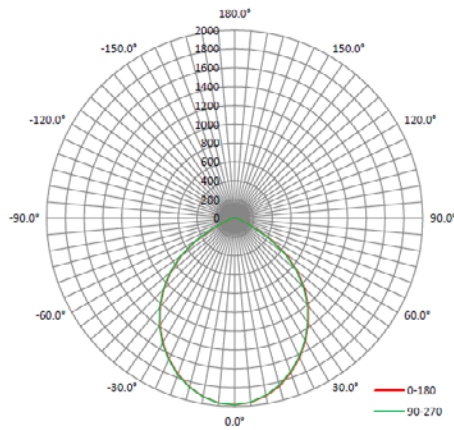

Accessories

Item Number	Ordering Abbreviation	Item Description
Trim Rings		
65710	RT4TRIM5ADKBZ	4" Bronze Trim Ring
65711	RT4TRIM5ASN	4" Satin Trim Ring
65712	RT4TRIM5ABLK	4" Black Trim Ring
65713	RT6TRIM5ADKBZ	6" Bronze Trim Ring
65714	RT6TRIM5ASN	6" Satin Trim Ring
65715	RT6TRIM5ABLK	6" Black Trim Ring
65716	RT8TRIM5ADKBZ	8" Bronze Trim Ring
65717	RT8TRIM5ASN	8" Satin Trim Ring
65718	RT8TRIM5ABLK	8" Black Trim Ring
65719	RT10TRIM5ADKBZ	10" Bronze Trim Ring
65720	RT10TRIM5ASN	10" Satin Trim Ring
65721	RT10TRIM5ABLK	10" Black Trim Ring
Trim Ring Extenders		
62788	RT68TRIMEXT5A	Trim extender for 8" cans
62789	RT810TRIMEXT5A	Trim extender for 10" cans
62790	RT812TRIMEXT5A	Trim extender for 12" cans
62366	RT1012TRIMEXT5A	Trim extender for 10" and 12" cans
RT4 Rough In Frame		
63743	MDFRAME1A	4" recessed rough-in frame
RT5/6 Rough		
71708	LED/RT6HO/FRAME	6" recessed rough-in frame
RT8 Rough In Frame		
71709	LED/RT8/FRAME	8" recessed rough-in frame

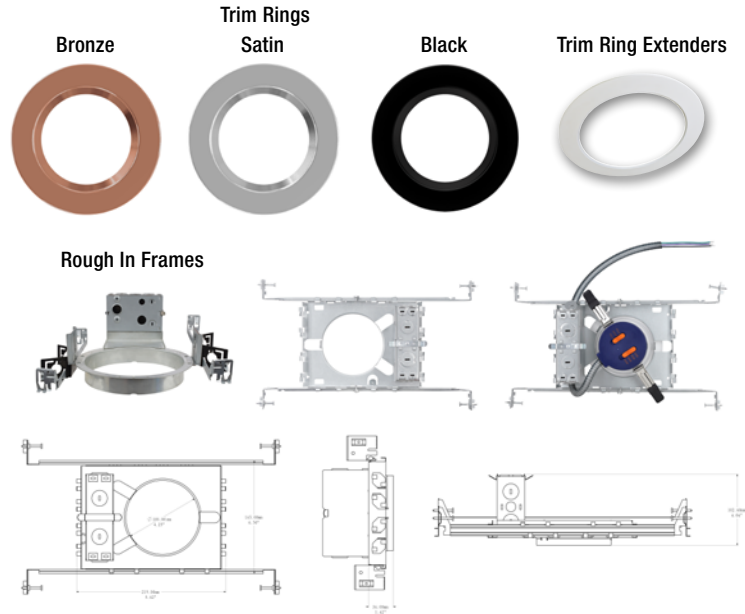

Trim Ring Extender Dimensions

Product Description	(A) Outer Diameter in (mm)	(B) Inner Diameter in (mm)	(C) Thickness in (mm)
62788	9.44 (240.00)	5.44 (138.73)	0.375 (9.50)
62789	11.44 (290.80)	7.125 (180.75)	0.438 (10.50)
62790	13.44 (341.60)	7.125 (180.75)	0.438 (10.80)
62366	13.44 (341.60)	8.125 (205.83)	0.438 (10.80)

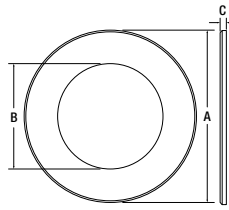

Emergency Battery Back-Up Accessories

For the EMBB application you must use the field-installable emergency back-up components listed below (sold separately).

Emergency Battery Back-Up Specs

NAED	Description	Input Voltage	Frequency	Input Current	Watt Hours	Max Mounting Height	Ambient Temp	Charging Time	Rating	Warranty
62367	EMBB2A8WUNVDC	100-277V _{AC}	50/60Hz	120mA Max	33.6Wh	21.6ft	0-50°C	24 hours	Damp	5 years
62368	EMBB2A8WUNHDC	100-347V _{AC}	50/60Hz	120mA Max	33.6Wh	21.6ft	0-50°C	24 hours	Damp	5 years

Description	(A) Length in (mm)	(B) Width in (mm)	(C) Height in (mm)
EMBB	12.9 (330)	2.6 (67)	2.2 (55)

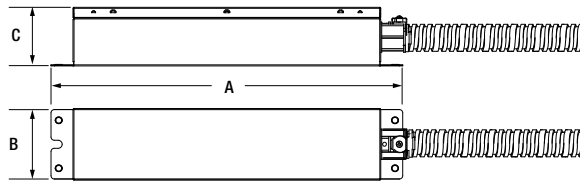

Compatibility Table

RT NAED	RT	NAED	EMBB Multi-listing	EMBB Wattage (W)*	EM Lumens (lm)*
62804	RT45AS700UNVD927WHTAA			8	700
62805	RT45AS700UNVD9SC8WHTAA			8	700
62806	RT65AS900UNVD927WHTAA			11	900
62807	RT65AS900UNVD9SC8WHTAA	62367/62368	EMBB2A8WUNVDC/ EMBB2A8WUNHDC	11	900
62808	RT65AS2000UNVD9SC8WHTAA			13	1400
62810	RT85AS3300UNVD9SC8WHTAA			13	1550
62811	RT105AS4000UNVD9SC8WHTAA			13	1600
62824	RT45AS1000UNH9SC8WH			8	700
62809	RT85AS2000UNVD9SC8WHTAA	62368	EMBB2A8WUNHDC	13	1400
62825	RT65AS2000UNH9SC8WH			13	1400
62826	RT85AS3000UNH9SC8WH			13	1550

*At the highest lumen level

EMBB Wiring Diagram

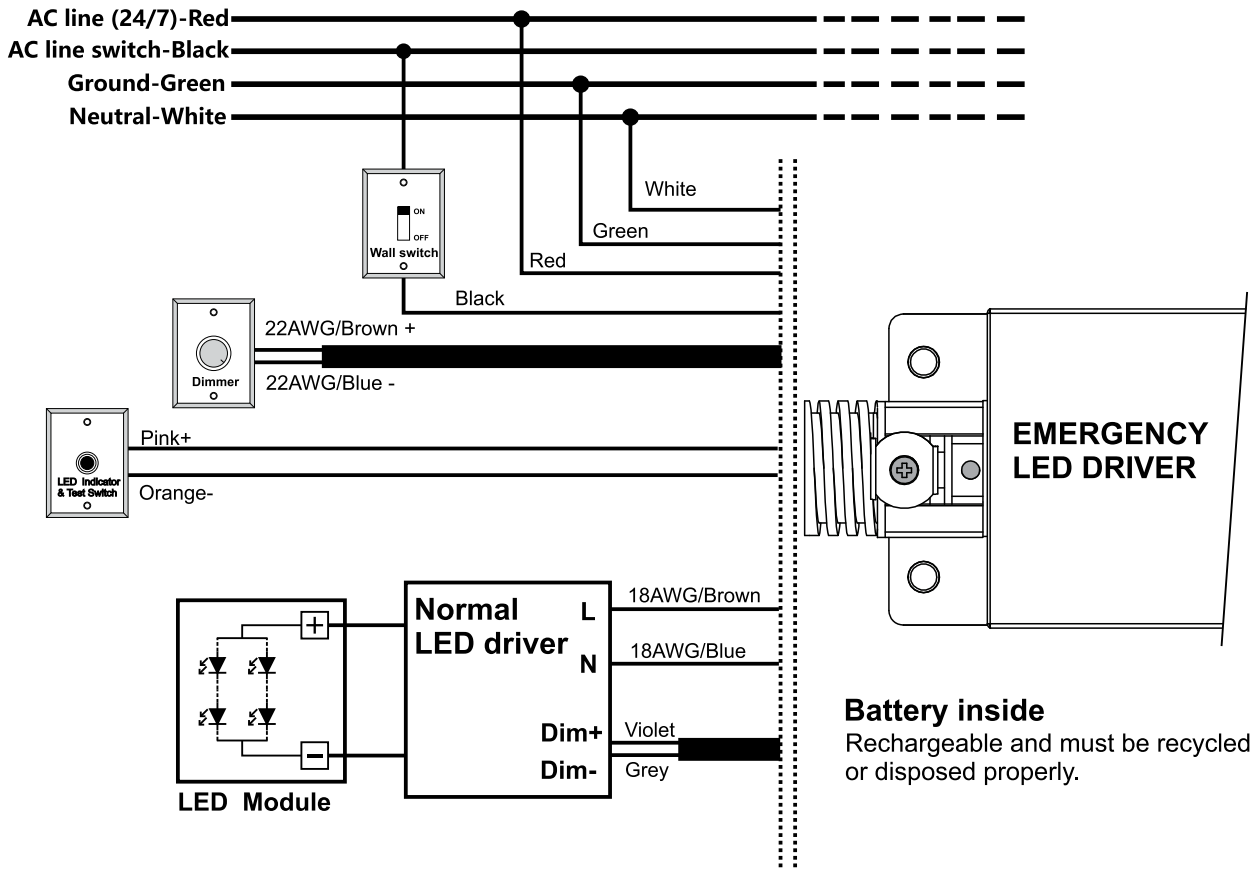

Hole Cut Templates

RT4 Hole Cut Template

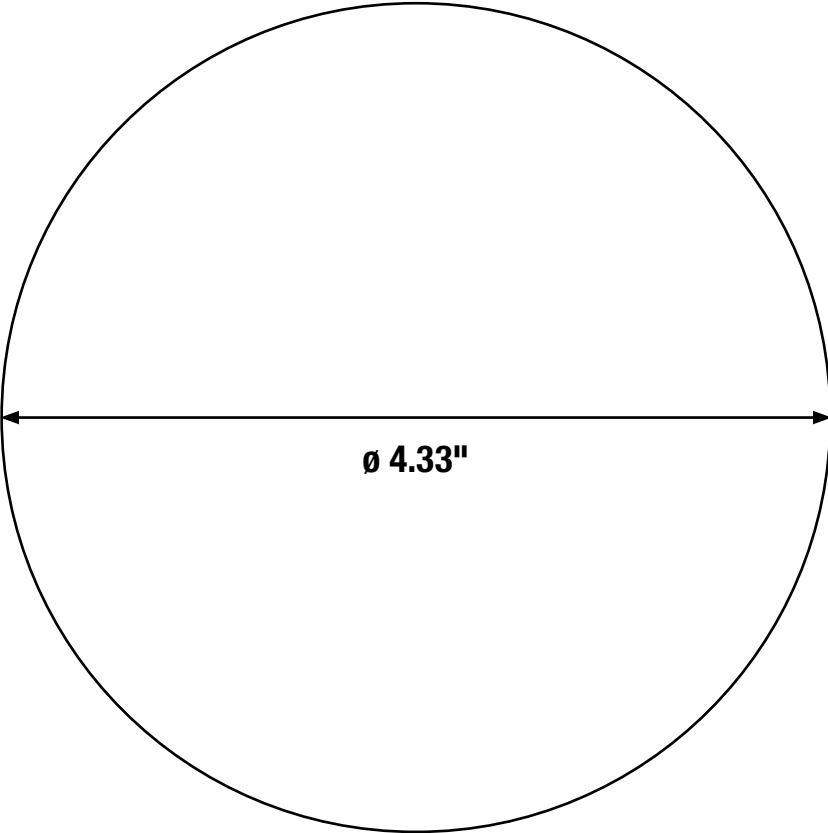

Hole Cut Templates

RT6 Hole Cut Template

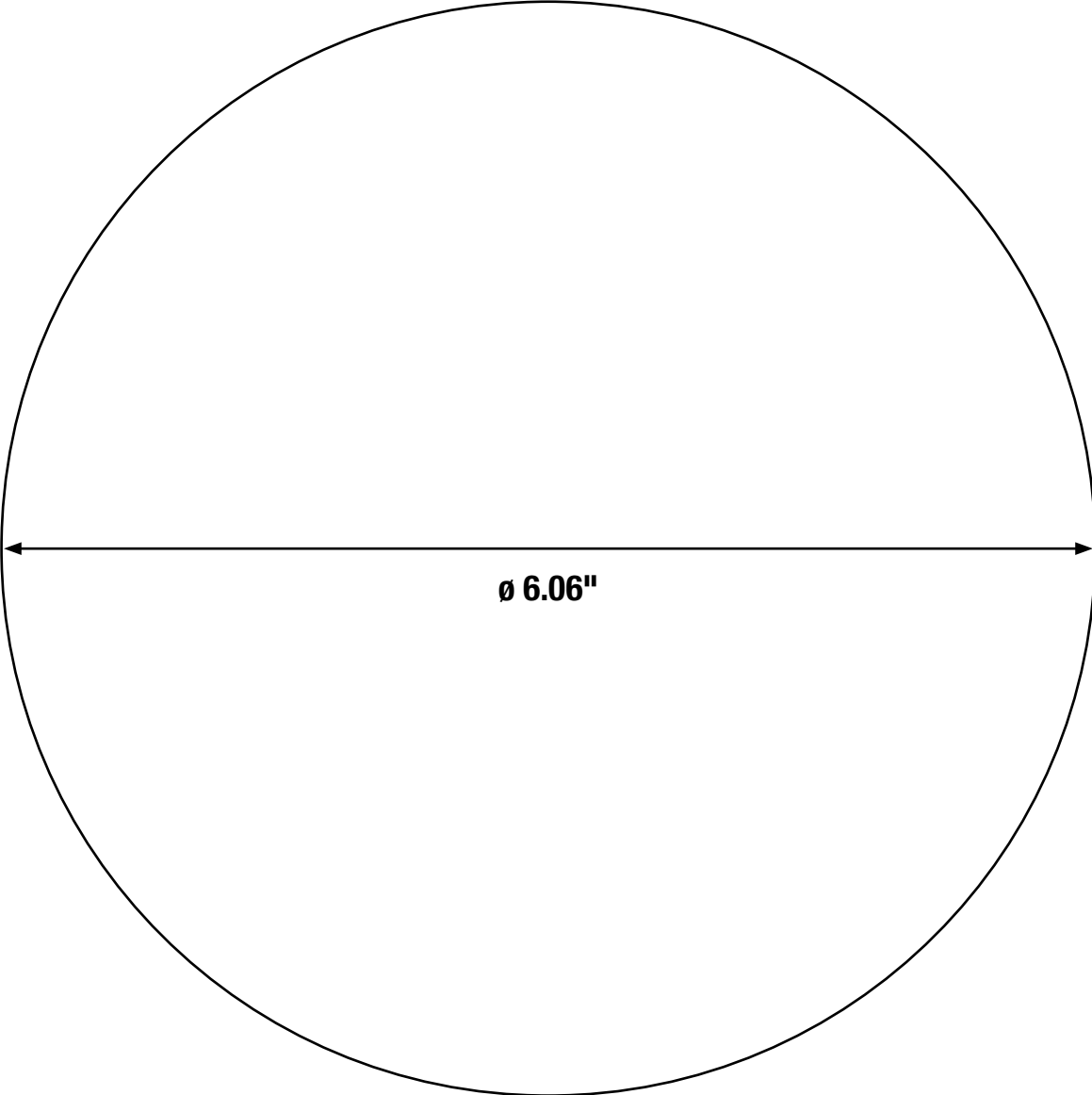

Hole Cut Templates

RT8 Hole Cut Template

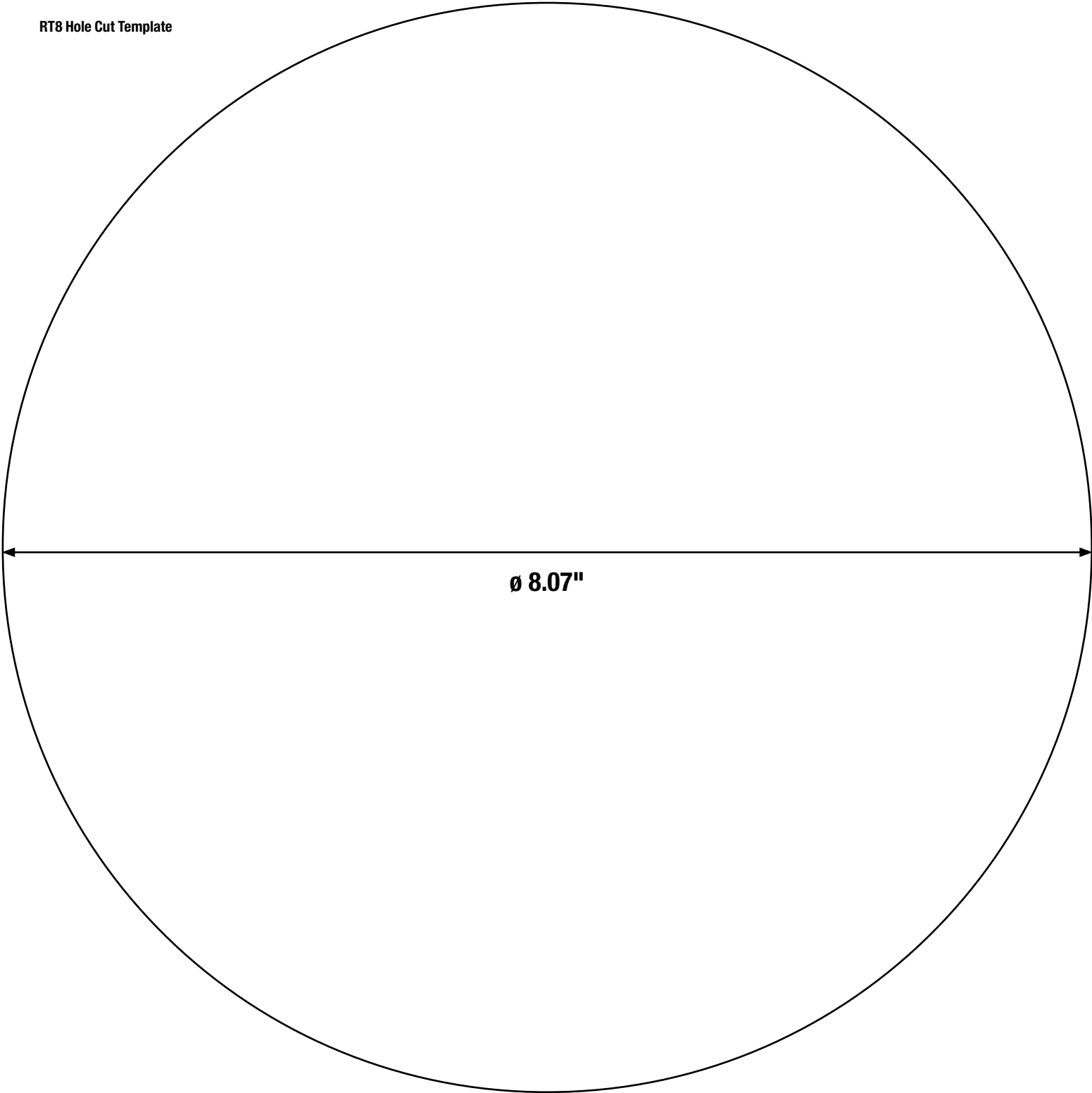

LEDVANCE LLC
181 Ballardvale Street, Suite 203
Wilmington, MA 01887 USA
Phone 1-800-LIGHTBULB (1-800-544-4828)
www.ledvanceUS.com

LEDVANCE is a registered trademark.
All other trademarks are those of their respective owners.
Specifications subject to change without notice.



SCAN TO FOLLOW US
ON SOCIAL MEDIA

