

SYLVANIA Luminaires

Outdoor Solar Powered Luminaires

Item #
Type
Project
Notes
Date

Application

The SYLVANIA Outdoor Solar Powered Luminaires are designed to add elegance to any outdoor atmosphere without sacrificing safety during nighttime hours. Incredibly simple to install, these solar powered luminaires do not require any wiring and are built to withstand exposure to outdoor elements. Practically maintenance-free, these luminaires do not require any additional LED bulbs. Running on sunlight, these luminaires are guaranteed to offer energy savings even when compared to existing LED technology.

Benefits and Features

- All products boast an IP44 rating ensuring a durable product capable of withstanding outdoor elements
- All products contain a rechargeable battery that will produce light for 8 hours when exposed to direct sunlight
- Many of these products include a motion or daylight sensor that both reduces energy consumption and increases security at night
- Color temperature: 2700K or 3000K for all outdoor landscape lights or 5000K for all security lighting
- CRI >80
- When compared to traditional technology, these products offer 100% energy savings by taking full advantage of the abundance of natural solar energy

Electrical

- These products run on solar energy, requiring 8 hours of exposure to reach a full charge
- Power Factor >0.9
- THD <20%

Rated Life

- 3,000 Hours at 114°F @8 hours of illumination per day

Warranty

- 1.5 years
- NLB Trusted Warranty Program

Operating Temperature

- -4°F to +114°F (-20°C to +45°C)



Certifications and Listings

- Mercury Free
- Lead Free
- IP44 Rated
- Wet Rated
- Damp Rated
- RoHS
- FCC

Installation

- All solar landscape products are easy to install. The spike-based products are placed directly into the ground in direct sunlight.
- All security luminaires are intended to be wall mounted. They mount in direct sunlight and include sensors that activate to keep you safe at night.



Ordering Guide

Path Light Luminaire

PATHLTX1A	/	1.2	SOL	8	30	/	XXIN	/	BL	/	P
PATHLTRD1A = Path Light, Round Head, Generation 1A PATHLTSQ1A = Path Light, Square Head, Generation 1A		1.2 = 1.2 lumens	SOL = Solar Powered	8 = CRI >80	30 = 3000K CCT		15IN = 15" height 14IN = 14" height		BL = Black housing		P = PIR sensor for detecting daylight

Spotlight Luminaire

SPOTLTRD1A	/	5	SOL	8	30	/	13IN	/	BL	/	P
SPOTLTRD1A = Round Spotlight Generation 1A		5 = 5 lumens	SOL = Solar Powered	8 = CRI >80	30 = 3000K CCT		13IN = 13" height		BL = Black housing		P = PIR sensor for detecting daylight

Lantern Luminaire

LANTERNSQ1A	/	100	SOL	8	27	/	WM	/	BL	/	P
LANTERNSQ1A = Square Lantern Luminaire Generation 1A		100 = 100 lumens	SOL = Solar Powered	8 = CRI >80	27 = 2700K CCT		WM = Wall Mount		BL = Black housing		P = PIR sensor for daylight/motion detection

Globe Luminaire

GLOBE1A	/	100	SOL	8	27	/	WM	/	SV	/	P
GLOBE1A = Globe Luminaire Generation 1A		100 = 100 lumens	SOL = Solar Powered	8 = CRI >80	27 = 2700K CCT		WM = Wall Mount		SV = Silver housing		P = PIR sensor for daylight/motion detection

Security Lighting Luminaire

SECURITY1A	/	XXXX	SOL	8	50	/	WM	/	XH	/	WH	/	P
SECURITY1A = Security Luminaire Generation 1A		400 = 400 lumens 1000 = 1000 lumens	SOL = Solar Powered	8 = CRI >80	50 = 5000K CCT		WM = Wall Mount		1H = 1 Head 2H = 2 Heads		WH = White housing		P = PIR sensor for daylight/motion detection

Post Cap Luminaire

POSTCAP1A	/	8	SOL	8	30	/	BL	/	P
POSTCAP1A = Post Cap Luminaire Generation 1A		8 = 8 lumens	SOL = Solar Powered	8 = CRI >80	30 = 3000K CCT		BL = Black housing		P = PIR sensor for detecting daylight

Solar Wall Luminaire

SOLWALL	/	008L	02V	8	30	/	BL
SOLWALL = Solar Wall Luminaire		008 = Consumes 8 watts of solar energy	02V = 2V	8 = CRI >80	30 = 3000K CCT		BL = Black finish

Ordering Information

Item Number	Ordering Abbreviation	Lumens (lm)	Input Voltage (V)	Dimming	CRI	Color Temp.	Material	Environment Rating
62404/62218	PATHLTRD1A/1.2SOL830/15IN/BI/P	1.2	0.8-1.5	Non dimming	>80	3000K	Plastic	IP44
62405	PATHLTSQ1A/1.2SOL830/14IN/BL/P	1.2	0.8-1.5	Non dimming	>80	3000K	Plastic	IP44
62406/62217	SPOTLTRD1A/5SOL830/13IN/BL/P	5	0.8-1.5	Non dimming	>80	3000K	Plastic	IP44
62407	LANTERNSQ1A/100SOL827/WM/BL/P	100	2-4.5	Non dimming	>80	3000K	Glass and plastic	IP44
62408	GLOBE1A/100SOL827/WM/SV/P	100	2-4.5	Non dimming	>80	3000K	Glass and plastic	IP44
62409	SECURITY1A/400SOL850/WM/1H/WH/P	400 when motion is detected	2-4.5	Non dimming	>80	5000K	Plastic	IP44
62410	SECURITY1A/1000SOL850/WM/2H/WH/P	1000 when motion sensor is detected, 5 lumens when in stand-by mode	2-4.5	Non dimming	>80	5000K	Plastic	IP44
62411	POSTCAP1A/8SOL830/BL/P	8	0.8-1.5	Non dimming	>80	3000K	Glass and plastic	IP44
62219	SOLWALL/008L/02V830/BL	2	2	Non dimming	>80	3000K	Plastic	IP44
65000	LEDFLDSOLAR/SOLAR850BL/D	600	2	Non dimming	>80	5000K	Plastic	IP44

*Please note: Canadian Customers can order 62404/62406, Customers in the United States can order 62217/62218.

Ordering Information (continued)

Item Number	Ordering Abbreviation	Battery Information	Sold in Quantities of	Mounting Method	Options
62404/62218	PATHLTRD1A/1.2SOL830/15IN/BI/P	1 x AA Ni-MH 300mAh	6/4	Ground mount	Daylight sensing
62405	PATHLTSQ1A/1.2SOL830/14IN/BL/P	1 x AAA Ni-MH 150mAh	10	Ground mount	Daylight sensing
62406/62217	SPOTLTRD1A/5SOL830/13IN/BL/P	1 x AA Ni-MH 600mAh	1/4	Ground or wall mount	Daylight sensing
62407	LANTERNSQ1A/100SOL827/WM/BL/P	1 x 3.7V 18650 1200mAh	1	Wall mount	Daylight/motion sensing
62408	GLOBE1A/100SOL827/WM/SV/P	1 x 3.7V 18650 1200mAh	1	Wall mount	Daylight/motion sensing
62409	SECURITY1A/400SOL850/WM/1H/WH/P	1 x 3.7V 18650 1200mAh	1	Wall mount	Daylight/motion sensing
62410	SECURITY1A/1000SOL850/WM/2H/WH/P	1 x 3.7V 18650 3000mAh	1	Wall mount	Daylight/motion sensing
62411	POSTCAP1A/8SOL830/BL/P	1 x J1AA Ni-MH 600mAh	1	Fence top mount	Daylight sensing
62219	SOLWALL/008L/02V830/BL	1 x AA Ni-MH 300mAh	2	Wall mount	Daylight sensing
65000	LEDFLDSOLAR/SOLAR850BL/D	1 x 3.7V 18650 1200mAh	1	Wall mount	Daylight sensing

Physical Information

Item Number	Length (mm)	Width (mm)	Height (mm)
62404/62218	100	100	398
62405	75	75	376
62406/62217	130	85	325
62407	105	90	180
62408	105	90	180
62409	104	180	186
62410	104	180	186
62411	133	133	132
62219	88	145	119
65000	110	30	192

62404/62218

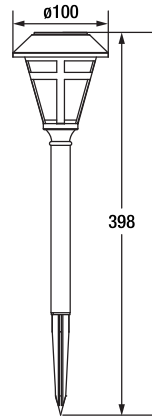

62405

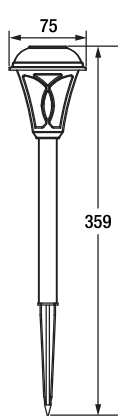

62406/62217

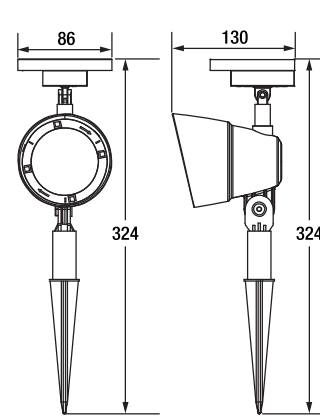

62407

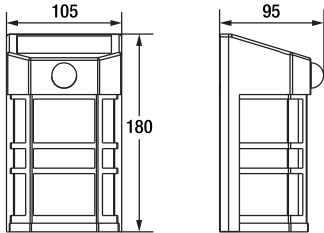

62408

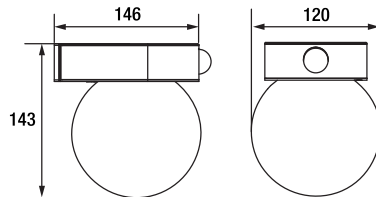

62411

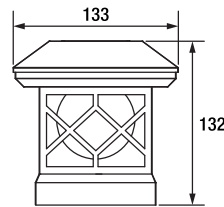

62219

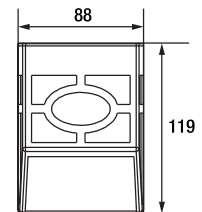

62409

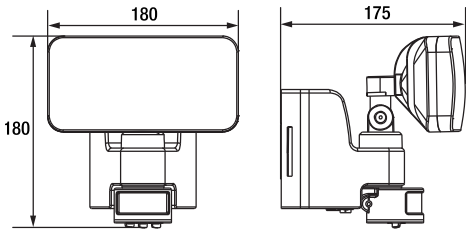

65000

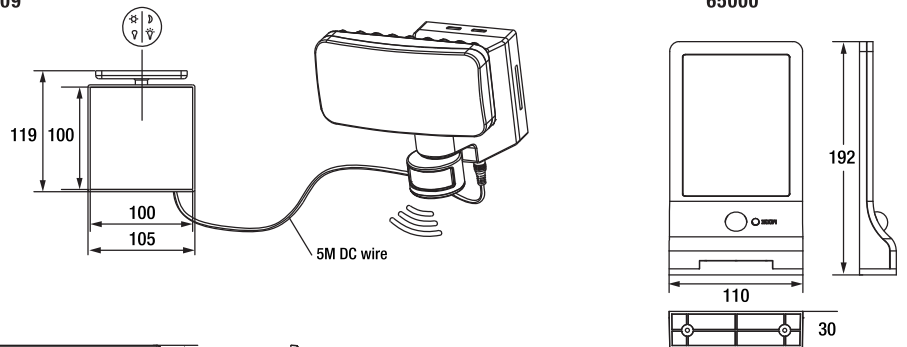

62410

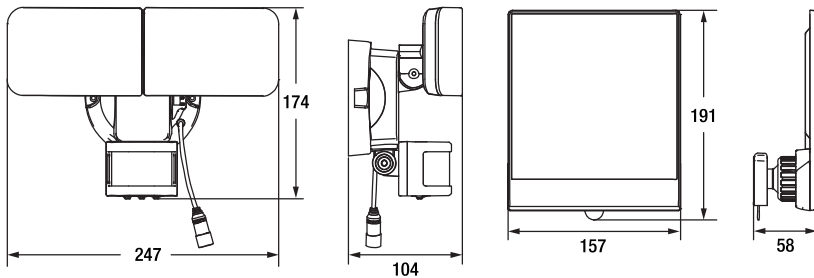

Dimensions in mm

LEDVANCE LLC
 200 Ballardvale Street
 Wilmington, MA 01887 USA
 Phone 1-800-LIGHTBULB (1-800-544-4828)
 www.ledvanceUS.com

SYLVANIA and LEDVANCE are registered trademarks.
 All other trademarks are those of their respective owners.
 Licensee of product trademark SYLVANIA in general lighting.
 Specifications subject to change without notice.

[/sylvania](#) [/sylvania](#)

Name: _____
 Email: _____
 Phone: _____

