

Project		Catalog #		Type	
Prepared by		Notes		Date	



# Sure-Lites

## SEL Emergency Light

LED Emergency Light  
 Up to 25, 50 or 60 feet egress coverage  
 Adjustable Optic  
 Self-Diagnostics Options  
 Remote Capacity Options

### Typical Applications

Office • Education • Healthcare • Hospitality • Retail • Manufacturing

### Interactive Menu

- Order Information page 2
- Photometric Data page 4
- Self Diagnostics page 6
- Product Warranty

### Product Certification



### Product Features



### Top Product Features

- Emergency egress coverage of 25 feet to 60 feet
- Total system coverage of 193 feet with remote capable versions
- Long life LED source with adjustable optics
- Sealed Nickel Cadmium battery
- Patented EZ hang and EZ Key features facilitate installation
- Multi-voltage input 120/240/277 VAC

### Dimensional Details

SEL25/SEL25SD/SEL50/SEL50SD

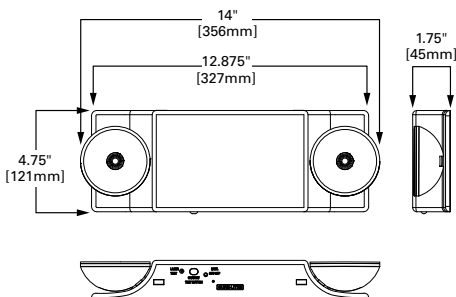

SEL25R10SD/SEL50R7SD/SEL60R4

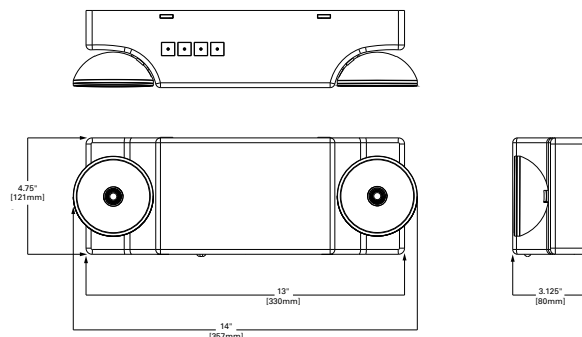

Catalog Logic for Non-Remote Capable Versions

SAMPLE ORDER NUMBER: **SEL25, SEL50**

Series	Coverage	Battery	Color	Self Diagnostic	Head Shape	Full Catalog Options
SEL=LED Emergency Light	25=25 feet 50=50 feet	__=NiCad	__=White	__=No Self Diagnostic SD=Self Diagnostic	__=Circular SQ=Square	SEL25, SEL25SQ, SEL25SD, SEL25SDSQ, SEL50, SEL50SQ, SEL50SD, SEL50SDSQ
SEL=LED Emergency Light	25=25 feet	__=NiCad	BK=Black	SD=Self Diagnostic (standard)	__=Circular	SEL25BKSD,
SEL=LED Emergency Light	50=50 feet	__=NiCad	BK=Black	SD=Self Diagnostic (standard)	__=Circular	SEL50BKSD

Catalog Logic for Remote Capable Versions

SAMPLE ORDER NUMBER: **SEL25R10SD, SEL50R7SD, SEL60R4**

Series	Spacing	Battery	Remote Capacity	Color	Self Diagnostic	Full Catalog Options
SEL=LED Emergency Light	25=25 feet	__=NiCad	R10=10 watts	__=White BK=Black	SD=Self Diagnostic (standard)	SEL25R10SD SEL25R10BKSD
SEL=LED Emergency Light	50=50 feet	__=NiCad	R7=7 watts	__=White BK=Black	SD=Self Diagnostic (standard)	SEL50R7SD SEL50R7BKSD
SEL=LED Emergency Light	60=60 feet	__=NiCad	R4=4 watts	__=White	__=No SD SD=Self Diagnostic	SEL60R4 SEL60R4SD
SEL=LED Emergency Light	60=260 feet	__=NiCad	R4=14 watts	BK=Black	SD=Self Diagnostic (standard)	SEL60R4BKSD

Emergency Egress Coverage; fixture spacing

Catalog Number	Output Lumens	0.1fc minimum		1fc minimum	
		7.5 foot height	20 foot height	7.5 foot height	20 foot height
SEL25	108	25 feet	12 feet	14 feet	12 feet
SEL50	218	50 feet	30 feet	21 feet	20 feet
SEL60	309	60 feet	52 feet	24 feet	30 feet

Electrical Characteristics During Charging Mode

SEL25 / SEL50 / SEL60

Model	120 volt			277 volt		
	Power (W)	Current (A)	PF	Power (W)	Current (A)	PF
SEL25	0.6	0.07	0.06	0.64	0.07	0.03
SEL25SD	0.6	0.07	0.07	0.67	0.07	
SEL50	1.0	0.15	0.05	1.02	0.14	
SEL50SD	1.2	0.15	0.06	1.19	0.14	
SEL60R4	1.7	0.25	0.06	1.62	0.21	
SEL60R4SD	2	0.3	0.07	1.8	0.2	
SEL25R10SD	2	0.3	0.07	1.8	0.2	
SEL50R7SD	2	0.3	0.07	1.8	0.2	

## Remote System Design Guidelines

SEL25/SEL50/SEL60

SEL Series Remote								
		Single Head Remotes				Double Head Remotes		
SRPA		SRP13/SRM13	SRP25/SRM25	SRP30/SRM30	SRP25D/SRM25D	SRP50D/SRM50D	SRP60D/SRM60D	
Watts Consumed		3.5	1.25	2.5	4.1	2.5	5	8.2
Catalog Number	Remote Watts Available	# of SRPA Remotes Fixture Will Power	# of SRP/SRM13 Remotes Fixture Will Power	# of SRP/SRM25 Remotes Fixture Will Power	# of SRP/SRM30 Remotes Fixture Will Power	# of SRP25D/SRM25D Remotes Fixture Will Power	# of SRP50D/SRM50D Remotes Fixture Will Power	# of SRP60D/SRM60D Remotes Fixture Will Power
SEL60R4	4	1	3	1	NA	1	NA	NA
SEL60R4SD	4	1	3	1	NA	1	NA	NA
SEL60R4BKSD	4	1	3	1	NA	1	NA	NA
SEL60R4BK	4	1	3	1	NA	1	NA	NA
SEL50R7SD	7	2	5	2	1	2	1	NA
SEL50R7BKSD	7	2	5	2	1	2	1	NA
SEL25R10SD	10	2	8	4	2	4	2	1
SEL25R10BKSD	10	2	8	4	2	4	2	1



SRP



SRPD



SRM



SRMD



SRPA WHITE



SRPA BLACK



SRPA BRONZE

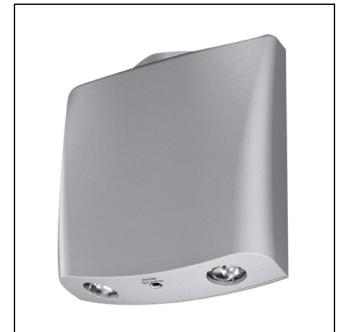

SRPA SILVER

## Remote System Design Guidelines

LEM Series Remote Wattage Consumption					
	Single Head Remotes		Double Head Remotes		
Catalog Number	LEM R1	LEMWR1	LEM R2	LEMWR2	
Watts Consumed	1.4	1.4	2.8	2.8	

  

LEM Series Remote Capacity					
Catalog Number	Remote Watts Available	# of LEM R1 Remotes Fixture Will Power	# of LEMWR1 Remotes Fixture Will Power	# of LEM R2 Remotes Fixture Will Power	# of LEMWR2 Remotes Fixture Will Power
SEL25R10SD	10	7	7	3	3
SEL25R10BKSD	10	7	7	3	3
SEL50R7SD	7	5	5	2	2
SEL50R7BKSD	7	5	5	2	2
SEL60R4	4	2	2	1	1
SEL60R4SD	4	2	2	1	1
SEL60R4BKSD	4	2	2	1	1

## Photometry

SEL 25

[View IES files](#)

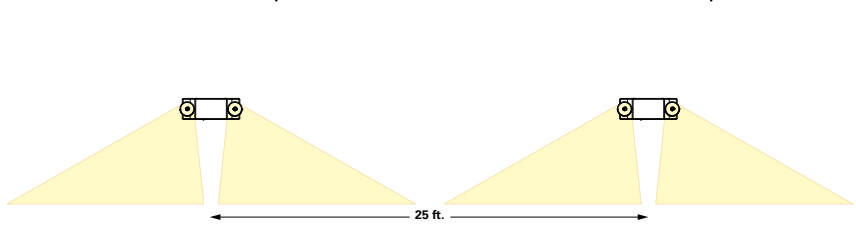
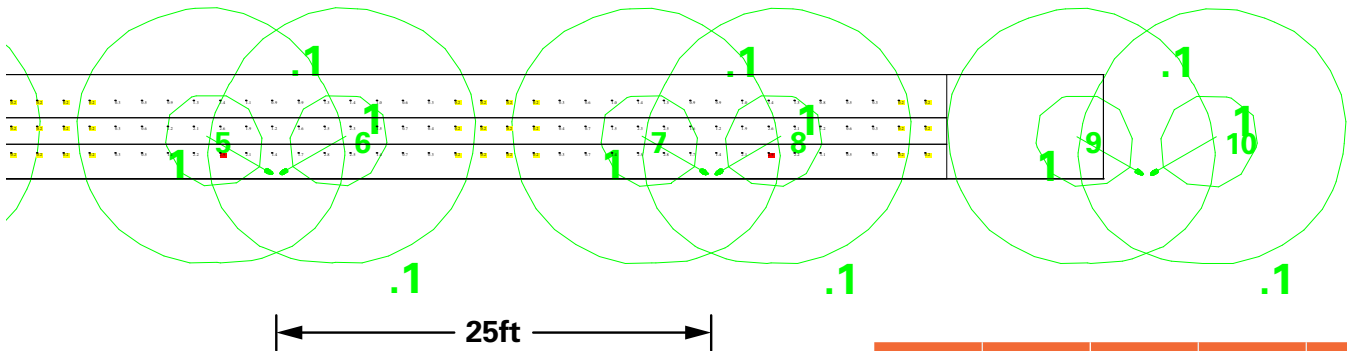

X	Y	Z	Orient	Tilt
-0.5	0.25	7.5	125	27
0.5	0.25	7.5	55	27
16.5	0.211	7.5	125	27
17.5	0.212	7.5	55	27
33.5	0.172	7.5	125	27
34.5	0.173	7.5	55	27
50.5	0.132	7.5	125	27
51.5	0.135	7.5	55	27
67.5	0.093	7.5	125	27
68.5	0.096	7.5	55	27
84.5	0.054	7.5	125	27
85.5	0.058	7.5	55	27
101.5	0.015	7.5	125	27
102.5	0.019	7.5	55	27

\*\*\*The "Rule of Thumb" spacing guidelines are designed to achieve 1 foot-candle average and 0.1 foot-candle minimum with a 40:1 maximum/minimum ratio. The corridor used is 100 feet long, 9 foot ceiling with a 6 foot wide walkway and 3 foot path of egress. The reflectances are 80% ceiling, 50% walls and 20% floors. The fixture mounting height is 7.5 feet. Cooper Lighting Solutions assumes no responsibility for local requirements or specific project variables. This is a guideline to be used as a design aid, not as guarantee of any code compliance.

Photometry

SEL50

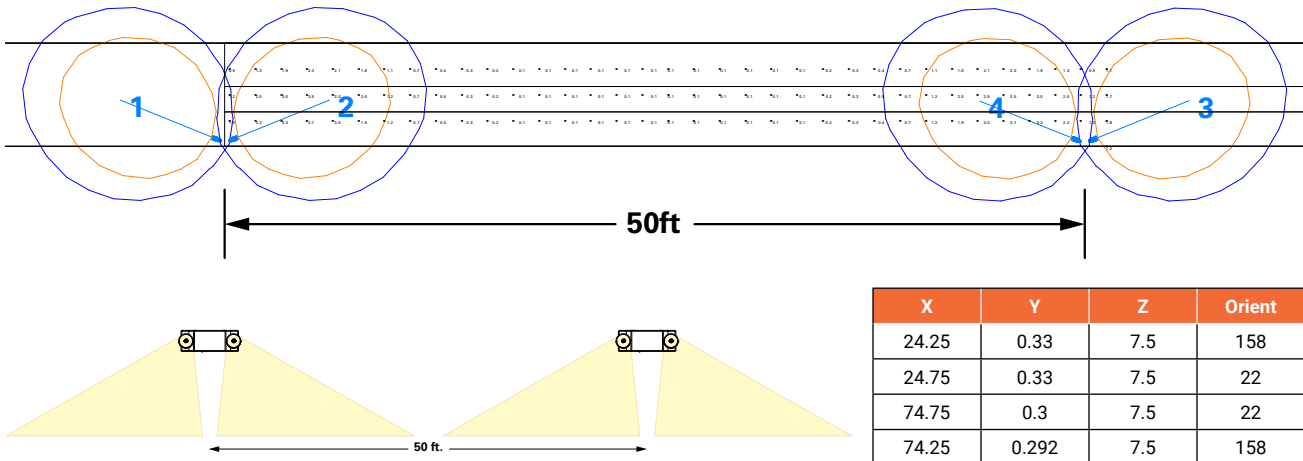

SEL60

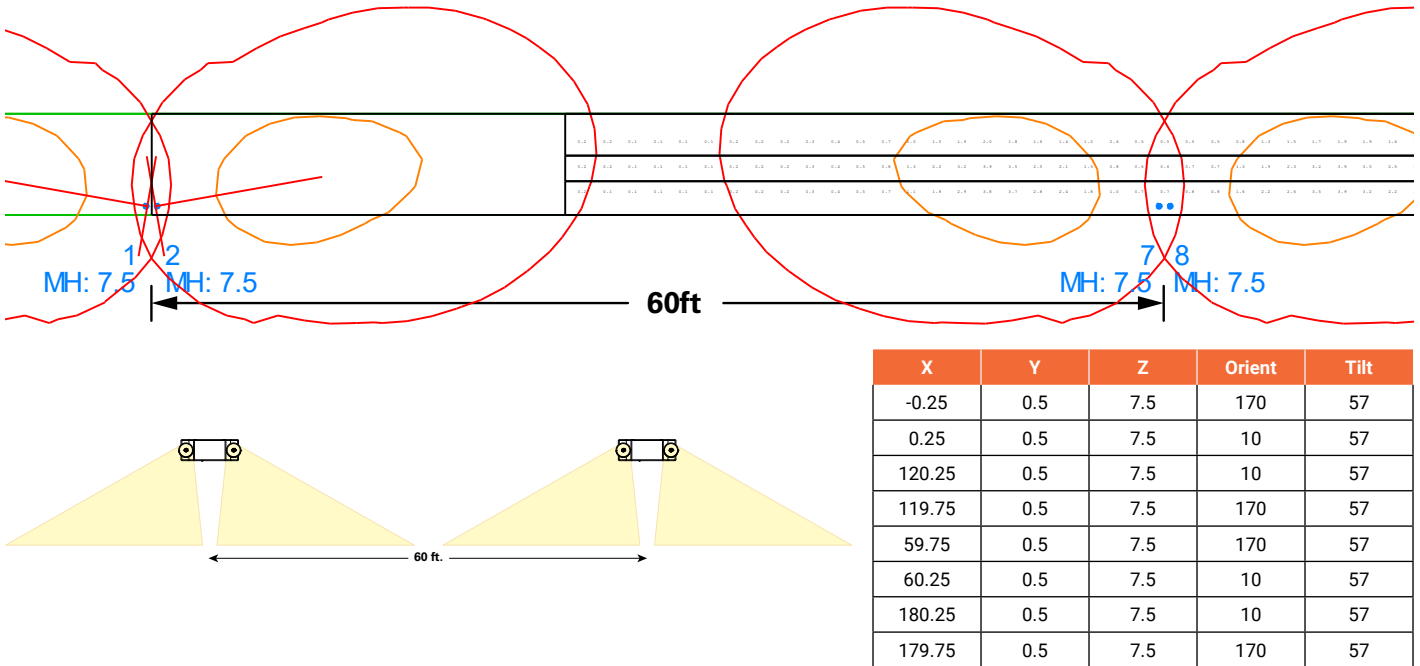

\*\*\*The "Rule of Thumb" spacing guidelines are designed to achieve 1 foot-candle average and 0.1 foot-candle minimum with a 40:1 maximum/minimum ratio. The corridor used is 100 feet long, 9 foot ceiling with a 6 foot wide walkway and 3 foot path of egress. The reflectances are 80% ceiling, 50% walls and 20% floors. The fixture mounting height is 7.5 feet. Cooper Lighting Solutions assumes no responsibility for local requirements or specific project variables. This is a guideline to be used as a design aid, not as guarantee of any code compliance.

## Technical Data

### Mechanical Housing

All components are injection molded with a color stable, high impact thermoplastic resin. The surface is textured to improve aesthetic appearance. The housing construction is designed with snap-fit components and reinforcement ribs to provide maximum strength at minimum installation effort. The mounting hole pattern is universal to junction box requirements and is suitable for both wall and ceiling mount applications.

### EZ Key – External Power Disconnect

Prevents the battery from cycling during the construction phase and ensures battery is not drained from power cycling.

### EZ Hang – Mounting Feature

The hands-free EZ Hang feature allows the installer to hang the emergency light face from the back plate in order to easily and efficiently make the power connections.

### Self Diagnostics

The self-diagnostic software will automatically perform all tests required by UL924, and NFPA101 and will systematically calibrate itself in the field; thus reducing installation labor and eliminating manual calibration errors. The system indicates the status of the emergency light at all times using the LED indicator. A 90 minute battery power (emergency mode) simulation test will occur once every 12 months. A 30 second battery power simulation test will occur every 30 days. The Solid-State microprocessor based system has the ability to accurately detect and warn of system failures, plus it incorporates all of the standard electronic features that sets Sure-Lites apart from its competition.

### Low Voltage Disconnect

The low-voltage circuitry disconnects the lighting load to protect the battery after run times in excess of the 90 minute UL limit. The disconnect remains in effect until normal utility power is restored preventing deep battery discharge.

### Brownout Circuit

The brownout circuit on the SEL emergency light monitors the flow of AC current to the unit and activates the emergency light heads when a predetermined reduction of AC power occurs.

### Warranty

SEL units are backed by a five-year warranty on the fixtures.



EZ Key



EZ Hang

## Self Diagnostic Testing Operations

The Sure-Lites Eagle Eye Self Diagnostics is continuously monitoring your emergency fixture, and will signal any failure through the 3 color indicator LED.

### Initial Operation:

When the unit is first powered up, it will go into a 24 hour fast charge, indicated by the indicator LED pulsing green. Once the unit has fully charged, it will perform a self calibration, after which the LED will change to steady green, indicating the unit is fully charged and float charging the battery to maintain readiness.

### Automatic Testing:

The unit will perform a battery capacity, lamp/LED, and charge circuit test every 30 days for 30 seconds. During this time, the indicator LED will change to a steady yellow. It will perform a full battery capacity (90 minute) test once per year. During this time, the indicator LED will change to a blinking yellow.

### Manual Testing:

- 10 Second "Installation" test – Press and release the test button once during fast charge (blinking green) to initiate a 10 second quick test. The sign will switch to emergency mode for 10 seconds allowing the installer to verify proper installation of the unit, and the LED indicator will turn solid yellow.
- 30 Second Test – Press and release the test button once during float charge (steady green). The indicator LED will turn steady yellow to indicate the unit is performing a 30 second test of the batteries and lamps/LEDs.
- 90 Minute Test – Press and release the test button a second time during a 30 second test (steady yellow) to change to a 90 minute test. During this test, the LED indicator will change to blinking yellow, and the circuit will perform a full battery capacity, charge circuit, and LED test.
- Canceling Test – Press and release the test button during the 90 minute test (flashing yellow) to return the fixture to its original state (fast charge or float charge)

### Laser Test:

The SEL SD products are equipped with a Laser Test function, that allows the unit to be manually tested without the need to physically press the test button. Shining a laser pointer in the hole marked "LASER TEST" on the bottom of the unit has the same effect as a press and release of the test button.

### Clearing Failure Codes:

- A battery failure (LED two blink red) can be cleared by replacing the battery. Disconnecting the battery and AC power, or performing a full 90 minute discharge, will reset the error code, however, it will return if the battery is faulty
- Charge Circuit (LED three blink red) and lamp/LED failure (LED four blink red) will clear when the unit successfully passes a manual or automatic 30 second test.

### Indicators:

- LED Off – No power to unit, emergency mode.
- LED Steady Green – Unit is fully charged and is float charging the battery to maintain readiness.
- LED Green Pulse – Unit is in a 24 hour fast charge of the battery.
- LED Two Blink Red – Battery has failed a capacity test, or the battery is disconnected. See "Clearing Failure Codes" above.
- LED Three Blink Red – Battery charge circuit has failed. See "Clearing Failure Codes" above.
- LED Four Blink Red – Lamps have burned out, or on an EXIT/Combo, 50% or more of the LEDs have failed. See "Clearing Failure Codes" above.
- LED Steady Yellow – 30 second test or 10 second quick test (Fast Charge only).
- LED Blinking Yellow – 90 minute test.

### Maintenance

None required. Replace the batteries as needed according to ambient conditions. However, we recommend that the equipment be tested regularly in accordance with local codes.

<ul style="list-style-type: none"> <li>○ OFF - EMERGENCY MODE / POWER OFF</li> <li>● STEADY BLINK GREEN - FAST CHARGE</li> <li>● STEADY GREEN - FULL / FLOAT CHARGE</li> <li>● STEADY YELLOW - QUICK TEST</li> </ul>	<ul style="list-style-type: none"> <li>● STEADY BLINK YELLOW - 90 MINUTE TEST</li> <li>● 2 BLINK RED - BATTERY FAILURE</li> <li>● 3 BLINK RED - CHARGE CIRCUIT FAILURE</li> <li>● 4 BLINK RED - LAMP/LED FAILURE</li> </ul>
--	---