



Slice Medium (SLM)

Outdoor LED Area Light



IP66 IK08



OVERVIEW

Lumen Package	9,000 - 55,000
Wattage Range	62 - 436
Efficacy Range (LPW)	114 - 162
Weight lbs(kg)	27 (12.2)
Control Options	IMSBT, ALB, ALS, 7-Pin, PCI

QUICK LINKS

[Ordering Guide](#)
[Performance](#)
[Photometrics](#)
[Dimensions](#)

FEATURES & SPECIFICATIONS

Construction

- Rugged die-cast aluminum housing contains factory prewired driver and optical unit. Cast aluminum wiring access door located underneath.
- Fixtures are finished with LSI's DuraGrip® polyester powder coat finishing process. The DuraGrip finish withstands extreme weather changes without cracking or peeling. Other standard LSI finishes available. Consult factory.
- Shipping weight: 33 lbs in carton.

Optical System

- State-of-the-Art one piece silicone optic sheet delivers industry leading optical control with an integrated gasket to provide IP66 rated seal.
- Proprietary silicone refractor optics provide exceptional coverage and uniformity in distribution types 2, 3, 4, 5W, FT, FTA, AM, and LC/RC.
- Silicone optical material does not yellow or crack with age and provides a typical light transmittance of 93-95%.
- Zero uplight.
- Available in 5000K, 4000K, and 3000K color temperatures per ANSI C78.377. Also available in phosphor converted amber with peak intensity at 610nm.
- Minimum CRI of 70
- Integral louver (IL) and integral half louver (IH) options available for enhanced backlight control.

Electrical

- High-performance driver features overvoltage, under-voltage, short-circuit and over temperature protection.
- 0-10V dimming (10% - 100%) standard.
- Standard Universal Voltage (120-277 VAC) Input 50/60 Hz or optional High Voltage (347-480 VAC).
- L80 Calculated Life: >100k Hours (See Lumen Maintenance chart)
- Total harmonic distortion: <20%
- Operating temperature: -40°C to +50°C (-40°F to +122°F). 42L and 48L lumen packages rated to +40°C. 55L lumen package rate to +35°C.
- Power factor: >.90
- Input power stays constant over life.
- Field replaceable 10kV surge protection device meets a minimum Category C Low operation (per ANSI/IEEE C62.41.2).
- High-efficacy LEDs mounted to metal-core circuit board to maximize heat dissipation
- Driver is fully encased in potting material for moisture resistance and complies with FCC standards. Driver and key electronic components can easily be accessed.

Controls

- Optional integral passive infrared Bluetooth™ motion sensor. Fixtures operate independently and can be commissioned via iOS or Android configuration app.
- LSI's AirLink™ wireless control system options reduce energy and maintenance costs while optimizing light quality 24/7.

Installation

- A single fastener secures the hinged door, underneath the housing and provides quick & easy access to the electrical compartment.
- Included terminal block accepts up to 12 ga. wire.
- Utilizes LSI's traditional B3 drill pattern. (See drawing in poles section)

Warranty

- LSI luminaires carry a 5-year limited warranty. Refer to <https://www.lsicorp.com/resources/terms-conditions-warranty/> for more information.

Listings

- Listed to UL 1598 and UL 8750.
- Meets Buy American Act requirements.
- Dark Sky compliant; with 3000K color temperature selection.
- Title 24 Compliant; see local ordinance for qualification information.
- Suitable for wet locations.
- IP66 rated Luminaire per IEC 60598-1.
- 3G rated for ANSI C136.31 high vibration applications applications are qualified.
- IK08 rated luminaire per IEC 66262 mechanical impact code.
- DesignLights Consortium® (DLC) qualified product. Not all versions of this product may be DLC qualified. Please check the DLC Qualified Products List at www.designlights.org/QPL to confirm which versions are qualified.
- Patented Silicone Optics (US Patent NO. 10,816,165 B2)

Slice Medium Outdoor LED Area Light

Type : _____

 **Have questions?** Call us at (800) 436-7800

ORDERING GUIDE

[Back to Quick Links](#)

TYPICAL ORDER EXAMPLE: SLM LED 36L SIL FTA UNV DIM 50 70CRI ALSCS04 BRZ IL						
Prefix	Light Source	Lumen Package	Lens	Distribution	Orientation ²	Voltage
SLM - Slice Medium	LED	9L - 9,000 lms 12L - 12,000 lms 18L - 18,000 lms 24L - 24,000 lms 30L - 30,000 lms 36L - 36,000 lms 42L - 42,000 lms 48L - 48,000 lms 55L - 55,000 lms Custom Lumen Packages ¹	SIL - Silicone	2 - Type 2 3 - Type 3 4 - Type 4 5W - Type 5 Wide FT - Forward Throw FTA - Forward Throw Automotive AM - Automotive Merchandise LC - Left Corner RC - Right Corner	(blank) - standard (no rotation) L - Optics rotated left 90° R - Optics rotated right 90°	UNV - Universal Voltage (120-277V) HV - High Voltage (347-480V)

Driver	Color Temperature	Color Rendering	Controls	Finish	Options
DIM - 0-10v Dimming (10-100%)	50 - 5,000 CCT 40 - 4,000 CCT 30 - 3,000 CCT AMB - Phosphor Converted Amber ⁸	70CRI - 70 CRI	(Blank) - None Wireless Controls System ALSC - AirLink Synapse Control System ⁹ ALSCS02 - AirLink Synapse Control System with 1.2-20' Motion Sensor ⁹ ALSCS04 - AirLink Synapse Control System with 20-40' Motion Sensor ⁹ ALBMR1LR - AirLink Blue Long Range Wireless Motion & Photo Sensor Controller (8-24' mounting height) ^{3,9} ALBMR2LR - AirLink Blue Long Range Wireless Motion & Photo Sensor Controller (25-40' mounting height) ^{3,9} Stand-Alone Controls EXT - 0-10V Dimming leads extended to housing exterior CR7P - 7 Pin Control Receptacle ANSI C1 36.41 ⁴ IMSBT1L - Integral Bluetooth™ Motion and Photocell Sensor (8-24' MH) ^{3,9} IMSBT2L - Integral Bluetooth™ Motion and Photocell Sensor (25-40' MH) ^{3,9} Button Type Photocells PCI120 - 120V PCI208-277 - 208 - 277V PCI347 - 347V	BLK - Black BRZ - Dark Bronze GMG - Gun Metal Gray GPT - Graphite MSV - Metallic Silver PLP - Platinum Plus SVG - Satin Verde Green WHT - White	(Blank) - None IH - Integral Half Louver (Moderate Spill Light Cutoff) ² IL - Integral Louver (Sharp Spill Light Cutoff) ²



Need more information?
[Click here for our glossary.](#)

Have additional questions?
 Call us at (800) 436-7800



ACCESSORY ORDERING INFORMATION⁵

CONTROLS ACCESSORIES	
Description	Order Number
Twist Lock Photocell (120V) for use with CR7P	122514
Twist Lock Photocell (208-277) for use with CR7P	122515
Twist Lock Photocell (347V) for use with CR7P	122516
Twist Lock Photocell (480V) for use with CR7P	1225180
AirLink 5 Pin Twist Lock Controller	61409
AirLink 7 Pin Twist Lock Controller	661410
Shorting Cap for use with CR7P	14932

MOUNTING ACCESSORIES ⁶	
Description	Order Number
Round Pole Adapter (3" Round/Tapered Poles)	408273CLR
Round Pole Adapter (4" Round Poles)	379967CLR
Round Pole Adapter (5" Round Poles)	379968CLR
B5 to B3 Adapter	800686BLK











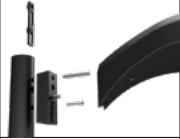

FUSING OPTIONS ⁷	
Single Fusing (120V)	See Fusing Accessory Guide
Single Fusing (277V)	
Double Fusing (208V, 240V)	
Double Fusing (480V)	
Double Fusing (347V)	

EXTERNAL SHIELDING OPTIONS	
3" External Shield	See Shielding Guide
6" External Shield	Guide

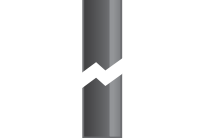
1. Custom lumen and wattage packages available, consult factory. Values are within industry standard tolerances but not DLC listed.
 2. Not available on "Type 5W" distribution. IL not available with LC/RC distributions.
 3. Motion sensors are field configurable via an app that can be downloaded from your smartphone's native app store. See controls section for more details.
 4. Control device or shorting cap must be ordered separately. See Accessory Ordering Information.
 5. Accessories are shipped separately and field installed.

6. "CLR" denotes finish. See Finish options.
 7. Fusing must be located in hand hole of pole. See Fusing Accessory Guide for compatibility.
 8. Only available in 9L, 12L, 18L, & 24L Lumen Packages. Consult factory for lead time and availability.
 9. Not available with 55L Lumen Package when 347-480V is specified.

ACCESSORIES

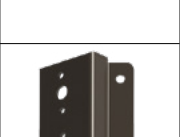
MOUNTING ACCESSORIES		SHIELDING, POLES & MISC. ACCESSORIES			
Side Arm	Universal Mounting Bracket Mounts to $\approx 3"$ square or round (tapered/straight) poles with (2) mounting hole spaces between 3.5" to 5" Part Number: BKA UMB CLR		Shielding	Integral Louver Field Install Integral Louver provides maximum backlight control by shielding each individual row of LEDs Part Number: 684812	
	Quick Mount Plate True one person installation to existing/new construction poles with hole spaces between 2.4 to 4.6" Part Number: BKS PQM B3B5 XX CLR			Integral Half Louver Field Install Integral Half Louver provides great backlight control without impacting front side distribution. Part Number: 743414	
	15° Tilt Quick Mount Plate True one person installation to existing/new construction poles with hole spaces between 2.4 to 4.6" Part Number: BKS PQ15 B3B5 XX CLR			External Shield External shield blocks view of light source from anyside of luminaire, additional shielding configurations available Part Number: 783607BLK (3") / 776538BLK (6")	
Tenon / Slipfitter	Adjustable Slipfitter Mounts onto a 2" (51mm) IP, 2.375" (60mm) O.D. tenon and provides 180° of tilt (max 45° above horizontal) Part Number: BKA ASF CLR		Poles	Square Poles 14 - 39" steel and aluminum poles in 4", 5" and 6" sizes for retrofit and new construction Part Number: 4SQ/5SQ/6SQ	
	Square Tenon Top Mounts onto a 2" (51mm) IP, 2.375" (60mm) O.D. tenon and allows for mounting up to 4 luminaires Part Number: BKA XNM *			Round Poles 10 - 30" steel and aluminum poles in 4" and 5" sizes for retrofit and new construction Part Number: 4RP/SRP	
	Square Internal Slipfitter Mounts inside 4" or 5" square pole and allows for mounting up to 4 luminaires Part Number: BKA X_ISF * CLR			Tapered Poles 20' - 39" steel and aluminum poles for retrofit and new construction Part Number: RTP	
Wall Mount / Wood Pole	Wall Mount Bracket Mounts onto vertical wall surface (hardware/anchors not included) Part Number: BKS XBO WM CLR		Misc.	Bird Spikes 10' linear bird spike (3' recommended per luminaire) silicone adhesive (covers approximately 25' linear fee of bird spike) and application tool Spike Part Number: 751631 Adhesive Part Number: 751632 Caulk Gun Part Number: 751636	
	Wood Pole Bracket Mounts onto wooden poles (6" minimum OD, hardware/anchors not included) Part Number: BKS XBO WP CLR			Replace CLR with paint finish description Replace XX with SQ for square pole or RD for round pole ($\geq 3"$ OD) Replace * with S (Single), D180 (Double @180°), D90 (Double @90°), T90 (Triple), Q90 (Quad) Replace _ with 4 (4" square pole) or 5 (5" square pole)	

OPTICS ROTATION

Top View

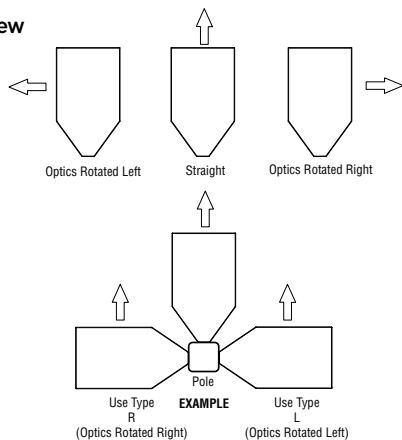

ACCESSORIES/OPTIONS

Integral Louver (IL) and House-Side Shield (IH)

Integral louver (IL) and half louver (IH) accessory shields available for improved backlight control without sacrificing street side performance. LSI's Integral Louver (IL) and Integral House-Side Shield (IH) options deliver backlight control that significantly reduces spill light behind the poles for applications with pole locations close to adjacent properties. The design maximizes forward reflected light while reducing glare, maintaining the optical distribution selected, and most importantly eliminating light trespass. Both options rotate with the optical distribution.

Luminaire Shown with Integral Louver (IL)



Luminaire Shown with IMSBT Option



7 Pin Photoelectric Control

7-pin ANSI C136.41-2013 control receptacle option available for twist lock photocontrols or wireless control modules. Control accessories sold separately. Dimming leads from the receptacle will be connected to the driver dimming leads (Consult factory for alternate wiring).



Slice Medium Outdoor LED Area Light

Type : _____

 Have questions? Call us at (800) 436-7800

PERFORMANCE

[Back to Quick Links](#)

DELIVERED LUMENS*												
Lumen Package	Distribution	CRI	3000K CCT			4000K CCT			5000K CCT			Wattage
			Delivered Lumens	Efficacy	BUG Rating	Delivered Lumens	Efficacy	BUG Rating	Delivered Lumens	Efficacy	BUG Rating	
9L	2	70	9411	149	B2-U0-G2	9603	152	B2-U0-G2	9603	152	B2-U0-G2	62
	3		9548	152	B2-U0-G2	9743	155	B2-U0-G2	9743	155	B2-U0-G2	
	4		9063	144	B1-U0-G3	9636	153	B1-U0-G3	9431	150	B1-U0-G3	
	5W		9261	147	B3-U0-G2	9450	150	B3-U0-G2	9450	150	B3-U0-G2	
	FT		9464	150	B2-U0-G2	9657	153	B2-U0-G2	9657	153	B2-U0-G2	
	FTA		9531	151	B2-U0-G2	9725	154	B2-U0-G2	9725	154	B2-U0-G2	
	AM		9649	153	B2-U0-G1	9845	156	B2-U0-G1	9845	156	B2-U0-G1	
	LC/RC		8949	144	B1-U0-G2	9515	153	B2-U0-G2	9313	150	B1-U0-G2	
12L	2	70	12533	147	B3-U0-G2	12788	150	B3-U0-G2	12788	150	B3-U0-G2	85
	3		12714	150	B2-U0-G2	12974	153	B2-U0-G2	12974	153	B2-U0-G2	
	4		12055	142	B2-U0-G3	12817	151	B2-U0-G4	12545	148	B2-U0-G3	
	5W		12333	145	B4-U0-G2	12584	148	B4-U0-G2	12584	148	B4-U0-G2	
	FT		12603	148	B2-U0-G2	12861	151	B2-U0-G2	12861	151	B2-U0-G2	
	FTA		12692	149	B3-U0-G2	12950	152	B3-U0-G2	12950	152	B3-U0-G2	
	AM		12848	151	B3-U0-G1	13111	154	B3-U0-G2	13111	154	B3-U0-G2	
	LC/RC		11903	137	B2-U0-G3	12656	145	B2-U0-G3	12387	142	B2-U0-G3	
18L	2	70	18421	136	B3-U0-G3	18797	139	B3-U0-G3	18797	139	B3-U0-G3	135
	3		18691	138	B3-U0-G3	19072	141	B3-U0-G3	19072	141	B3-U0-G3	
	4		17783	132	B2-U0-G4	18908	140	B2-U0-G4	18506	137	B2-U0-G4	
	5W		18128	134	B4-U0-G2	18498	137	B4-U0-G2	18498	137	B4-U0-G2	
	FT		18526	137	B3-U0-G3	18904	140	B3-U0-G3	18904	140	B3-U0-G3	
	FTA		18656	138	B3-U0-G3	19037	141	B3-U0-G3	19037	141	B3-U0-G3	
	AM		18886	140	B3-U0-G2	19271	143	B3-U0-G2	19271	143	B3-U0-G2	
	LC/RC		17559	131	B2-U0-G3	18670	139	B2-U0-G3	18273	136	B2-U0-G3	
24L	2	70	23361	145	B4-U0-G3	24506	152	B4-U0-G3	24414	152	B4-U0-G3	161
	3		23998	149	B3-U0-G3	25174	156	B3-U0-G3	25079	156	B3-U0-G3	
	4		24496	152	B3-U0-G5	25672	159	B3-U0-G5	25662	159	B3-U0-G5	
	5W		23788	148	B5-U0-G3	24953	155	B5-U0-G3	24859	154	B5-U0-G3	
	FT		24059	149	B3-U0-G3	25238	157	B3-U0-G3	25143	156	B3-U0-G3	
	FTA		23079	143	B3-U0-G3	24210	150	B4-U0-G3	24119	150	B4-U0-G3	
	AM		24051	149	B3-U0-G2	25229	157	B3-U0-G2	25134	156	B3-U0-G2	
	LC/RC		24353	151	B3-U0-G4	25522	159	B3-U0-G4	25522	159	B3-U0-G4	
30L	2	70	29464	138	B4-U0-G3	30908	145	B4-U0-G3	30791	145	B4-U0-G3	213
	3		30268	142	B3-U0-G4	31751	149	B3-U0-G4	31631	149	B3-U0-G4	
	4		30609	144	B3-U0-G5	32079	151	B3-U0-G5	32066	151	B3-U0-G5	
	5W		30002	141	B5-U0-G3	31472	148	B5-U0-G3	31353	147	B5-U0-G3	
	FT		30345	142	B4-U0-G4	31832	149	B4-U0-G4	31712	149	B4-U0-G4	
	FTA		29109	137	B4-U0-G4	30535	143	B4-U0-G4	30420	143	B4-U0-G4	
	AM		30334	142	B4-U0-G3	31820	149	B4-U0-G3	31700	149	B4-U0-G3	
	LC/RC		30430	143	B3-U0-G5	31891	150	B3-U0-G5	31891	150	B3-U0-G5	
36L	2	70	34123	134	B4-U0-G3	35795	140	B4-U0-G3	35660	140	B4-U0-G3	255
	3		35053	137	B4-U0-G4	36771	144	B4-U0-G4	36632	144	B4-U0-G4	
	4		35414	139	B3-U0-G5	37114	146	B3-U0-G5	37099	145	B3-U0-G5	
	5W		34745	136	B5-U0-G4	36448	143	B5-U0-G4	36311	142	B5-U0-G4	
	FT		35142	138	B4-U0-G4	36864	145	B4-U0-G4	36725	144	B4-U0-G4	
	FTA		33711	132	B4-U0-G4	35363	139	B4-U0-G4	35230	138	B4-U0-G4	
	AM		35130	138	B4-U0-G3	36851	145	B4-U0-G3	36712	144	B4-U0-G3	
	LC/RC		35207	138	B3-U0-G5	36897	145	B3-U0-G5	36897	145	B3-U0-G5	
42L	2	70	39966	127	B5-U0-G4	41925	134	B5-U0-G4	41767	133	B5-U0-G4	314
	3		41056	131	B4-U0-G5	43068	137	B4-U0-G5	42905	137	B4-U0-G5	
	4		41518	132	B3-U0-G5	43511	139	B4-U0-G5	43494	139	B4-U0-G5	
	5W		40696	130	B5-U0-G4	42690	136	B5-U0-G4	42529	135	B5-U0-G4	
	FT		41161	131	B4-U0-G4	43178	138	B4-U0-G4	43015	137	B4-U0-G4	
	FTA		39484	126	B4-U0-G4	41419	132	B5-U0-G4	41263	131	B5-U0-G4	
	AM		41146	131	B4-U0-G3	43162	137	B4-U0-G3	43000	137	B4-U0-G3	
	LC/RC		41275	131	B3-U0-G5	43256	137	B3-U0-G5	43256	137	B3-U0-G5	
48L	2	70	44390	121	B5-U0-G4	46565	127	B5-U0-G4	46389	126	B5-U0-G4	367
	3		45325	124	B4-U0-G5	47547	130	B4-U0-G5	47367	129	B4-U0-G5	
	4		45996	125	B4-U0-G5	48204	131	B4-U0-G5	48186	131	B4-U0-G5	
	5W		45002	123	B5-U0-G4	47435	129	B5-U0-G4	47302	129	B5-U0-G4	
	FT		44799	122	B4-U0-G5	46994	128	B4-U0-G5	46817	128	B4-U0-G5	
	FTA		44590	121	B5-U0-G4	46775	127	B5-U0-G4	46599	128	B5-U0-G4	
	AM		46310	126	B4-U0-G3	48579	132	B4-U0-G3	48396	132	B4-U0-G3	
	LC/RC		45726	125	B4-U0-G5	47921	131	B4-U0-G5	47921	131	B4-U0-G5	

Slice Medium Outdoor LED Area Light

Type : _____

 Have questions? Call us at (800) 436-7800

PERFORMANCE (CONT.)

[Back to Quick Links](#)

DELIVERED LUMENS*												
Lumen Package	Distribution	CRI	3000K CCT			4000K CCT			5000K CCT			Wattage
			Delivered Lumens	Efficacy	BUG Rating	Delivered Lumens	Efficacy	BUG Rating	Delivered Lumens	Efficacy	BUG Rating	
55L	2	70	49583	114	B5-U0-G4	52012	119	B5-U0-G4	51816	119	B5-U0-G4	436
	3		50934	117	B4-U0-G5	53430	123	B4-U0-G5	53229	122	B4-U0-G5	
	4		50544	116	B4-U0-G5	52970	121	B4-U0-G5	52950	121	B4-U0-G5	
	5W		50487	116	B5-U0-G4	52961	121	B5-U0-G4	52761	121	B5-U0-G4	
	FT		51064	117	B4-U0-G5	53566	123	B4-U0-G5	53364	122	B4-U0-G5	
	FTA		48984	112	B5-U0-G4	51384	118	B5-U0-G4	51191	117	B5-U0-G4	
	AM		51045	117	B4-U0-G3	53546	123	B4-U0-G3	53344	122	B4-U0-G3	
	LC/RC		50247	116	B4-U0-G5	52659	121	B4-U0-G5	52659	121	B4-U0-G5	

ELECTRICAL DATA (AMPS) - 3000K/4000K/5000K*						
Lumens	120V	208V	240V	277V	347V	480V
9L	0.52	0.30	0.26	0.22	0.18	0.13
12L	0.71	0.41	0.35	0.31	0.24	0.18
18L	1.13	0.65	0.56	0.49	0.39	0.28
24L	1.34	0.77	0.67	0.58	0.46	0.34
30L	1.78	1.02	0.89	0.77	0.61	0.44
36L	2.13	1.23	1.06	0.92	0.73	0.53
42L	2.62	1.51	1.31	1.13	0.90	0.65
48L	3.06	1.76	1.53	1.32	1.06	0.76
55L	3.63	2.10	1.82	1.57	1.26	0.91

RECOMMENDED LUMEN MAINTENANCE ¹ (0-25°C)					
Ambient	Initial ²	25h ²	50hr ²	75hr ²	100hr ²
9L - 18L	100%	97%	93%	90%	86%
24L - 48L	100%	95%	89%	84%	79%
55L	100%	91%	82%	74%	67%

RECOMMENDED LUMEN MAINTENANCE ¹ (40°C)					
Ambient	Initial ²	25h ²	50hr ²	75hr ²	100hr ²
7L - 18L	100%	97%	92%	88%	84%
24L - 48L	100%	94%	87%	80%	74%

RECOMMENDED LUMEN MAINTENANCE ¹ (50°C)					
Ambient	Initial ²	25h ²	50hr ²	75hr ²	100hr ²
7L - 18L	100%	96%	91%	87%	83%

DELIVERED LUMENS*					
Lumen Package	Distribution	Phosphor Converted Amber (Peak 610nm)			Wattage
		Delivered Lumens	Efficacy	BUG Rating	
9L	2	5848	80	B2-U0-G2	74
	3	6018	82	B1-U0-G2	
	5W	5471	74	B3-U0-G1	
	FT	5801	79	B1-U0-G2	
	FTA	5924	81	B1-U0-G1	
12L	2	7530	74	B2-U0-G2	102
	3	7749	76	B1-U0-G2	
	5W	7045	69	B3-U0-G2	
	FT	7470	73	B2-U0-G2	
	FTA	7628	75	B2-U0-G2	
18L	2	9311	69	B2-U0-G2	135
	3	9582	71	B2-U0-G2	
	5W	8712	65	B3-U0-G2	
	FT	9237	68	B2-U0-G2	
	FTA	9433	70	B2-U0-G2	
24L	2	10955	63	B2-U0-G2	175
	3	11273	64	B2-U0-G2	
	5W	10249	59	B3-U0-G2	
	FT	10867	62	B2-U0-G2	
	FTA	11097	63	B2-U0-G2	
AM	11230	64	B2-U0-G1		

ELECTRICAL DATA - Phosphor Converted Amber (AMPS)*						
Lumens	120V	208V	240V	277V	347V	480V
9L	0.62	0.36	0.31	0.27	0.21	0.15
12L	0.85	0.50	0.43	0.38	0.30	0.22
18L	1.13	0.65	0.56	0.49	0.39	0.28
24L	1.47	0.85	0.73	0.64	0.51	0.37

*Electrical data at 25°C (77°F). Actual wattage may differ by +/-10%

*LEDs are frequently updated therefore values are nominal.

- Lumen maintenance values at 25°C are calculated per TM-21 based on LM-80 data and in-situ testing.
- In accordance with IESNA TM-21-11, Projected Values represent interpolated value based on time durations that are within six times the IESNA LM-80-08 total test duration for the device under testing.
- In accordance with IESNA TM-21-11, Calculated Values represent time durations that exceed six times the IESNA LM-80-08 total test duration for the device under testing.

Slice Medium Outdoor LED Area Light

Type : _____

 Have questions? Call us at (800) 436-7800

PHOTOMETRICS

[Back to Quick Links](#)

Luminaire photometry has been conducted by an accredited laboratory in accordance with IESNA LM-79. As specified by IESNA LM-79 the entire luminaire is tested as the source resulting in a luminaire efficiency of 100%.

SLM-LED-30L-SIL-2-40-70CRI

Luminaire Data	
Type 2 Distribution	
Description	4000 Kelvin, 70 CRI
Delivered Lumens	30,908
Watts	213
Efficacy	145
IES Type	Type II - Short
BUG Rating	B4-U0-G3

Zonal Lumen Summary		
Zone	Lumens	% Luminaire
Low (0-30°)	5,206	17%
Medium (30-60°)	19,108	62%
High (60-80°)	6,293	20%
Very High (80-90°)	301	1%
Uplight (90-180°)	0	0%
Total Flux	30,908	100%

ISO Footcandle

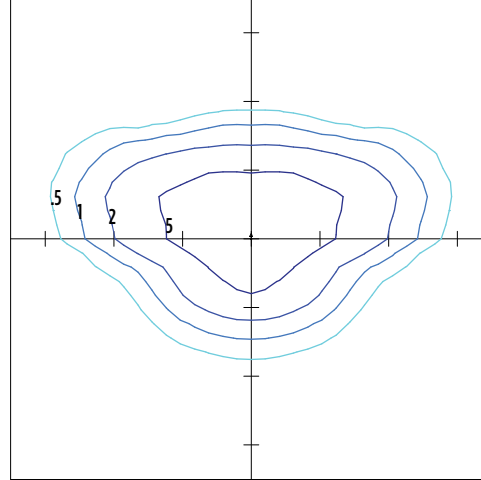

25' Mounting Height / 25' Grid Spacing
 5 FC 2 FC 1 FC 0.5 FC

Polar Curve

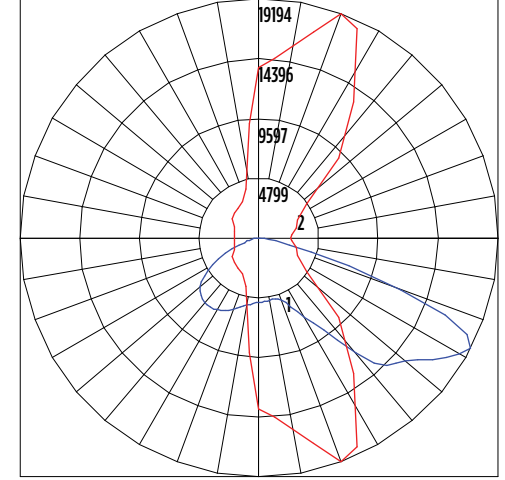

Vertical Plane Horizontal Cone

SLM-LED-30L-SIL-3-40-70CRI

Luminaire Data	
Type 3 Distribution	
Description	4000 Kelvin, 70 CRI
Delivered Lumens	31,751
Watts	213
Efficacy	149
IES Type	Type III - Short
BUG Rating	B3-U0-G4

Zonal Lumen Summary		
Zone	Lumens	% Luminaire
Low (0-30°)	3,533	11%
Medium (30-60°)	18,345	58%
High (60-80°)	9,441	30%
Very High (80-90°)	432	1%
Uplight (90-180°)	0	0%
Total Flux	31,751	100%

ISO Footcandle

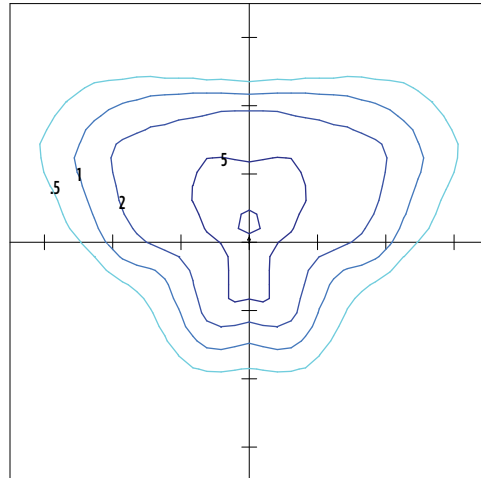

25' Mounting Height / 25' Grid Spacing
 5 FC 2 FC 1 FC 0.5 FC

Polar Curve

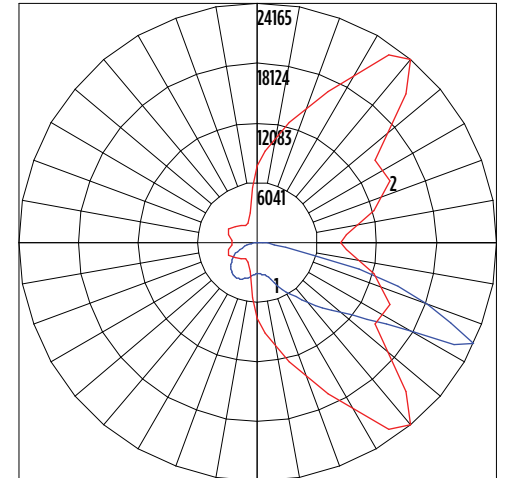

Vertical Plane Horizontal Cone

Slice Medium Outdoor LED Area Light

Type : _____

 Have questions? Call us at (800) 436-7800

PHOTOMETRICS (CONT.)

SLM-LED-30L-SIL-FT-40-70CRI

Luminaire Data	
Type FT Distribution	
Description	4000 Kelvin, 70 CRI
Delivered Lumens	31,832
Watts	213
Efficacy	149
IES Type	Type IV - Short
BUG Rating	B4-U0-G4

Zonal Lumen Summary		
Zone	Lumens	% Luminaire
Low (0-30°)	4,047	13%
Medium (30-60°)	16,376	51%
High (60-80°)	10,861	34%
Very High (80-90°)	549	2%
Uplight (90-180°)	0	0%
Total Flux	31,832	100%

ISO Footcandle

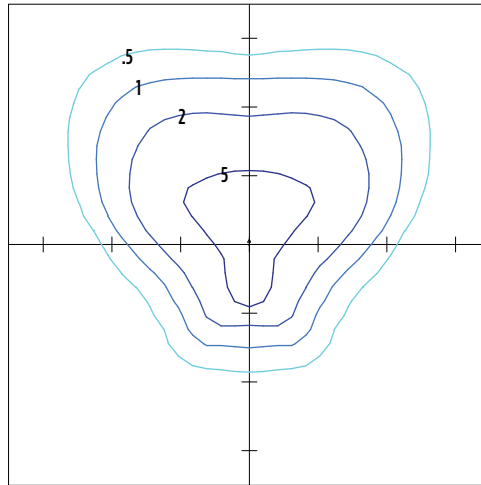

25' Mounting Height / 25' Grid Spacing
 ■ 5 FC ■ 2 FC ■ 1 FC ■ 0.5 FC

Polar Curve

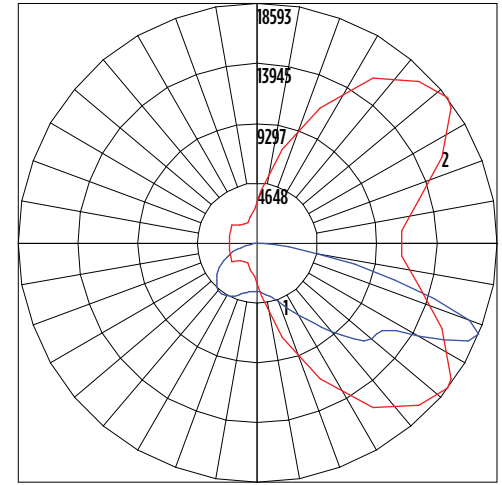

■ Vertical Plane ■ Horizontal Cone

SLM-LED-30L-SIL-4-40-70CRI

Luminaire Data	
Type 4 Distribution	
Description	4000 Kelvin, 70 CRI
Delivered Lumens	32,079
Watts	213
Efficacy	150
IES Type	Type IV - Very Short
BUG Rating	B3-U0-G3

Zonal Lumen Summary		
Zone	Lumens	% Luminaire
Low (0-30°)	3,429	11%
Medium (30-60°)	14,044	44%
High (60-80°)	13,233	41%
Very High (80-90°)	1,373	4%
Uplight (90-180°)	0	0%
Total Flux	32,079	100%

ISO Footcandle

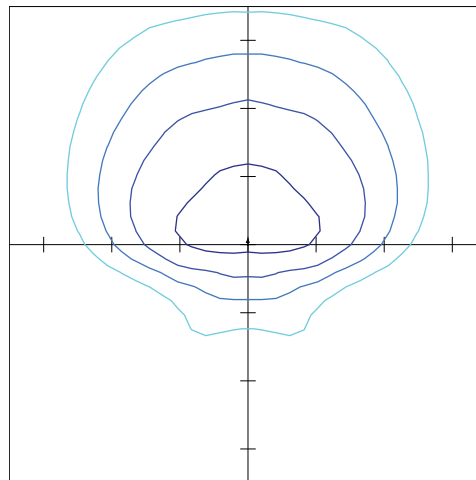

25' Mounting Height / 25' Grid Spacing
 ■ 5 FC ■ 2 FC ■ 1 FC ■ 0.5 FC

Polar Curve

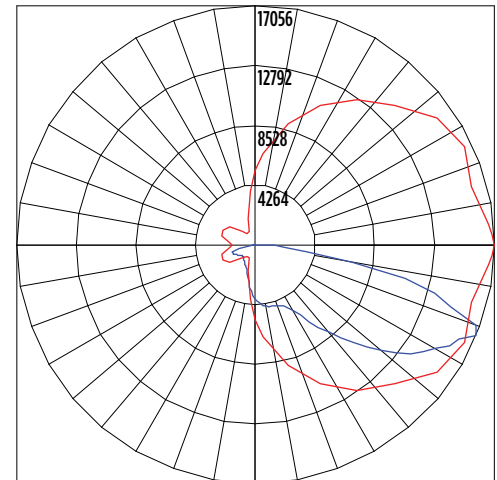

■ Vertical Plane ■ Horizontal Cone

Slice Medium Outdoor LED Area Light

Type : _____

 Have questions? Call us at (800) 436-7800

PHOTOMETRICS (CONT.)

SLM-LED-30L-SIL-5W-40-70CRI

Luminaire Data	
Type FW Distribution	
Description	4000 Kelvin, 70 CRI
Delivered Lumens	31,472
Watts	213
Efficacy	148
IES Type	Type VS - Short
BUG Rating	B5-U0-G3

Zonal Lumen Summary		
Zone	Lumens	% Luminaire
Low (0-30°)	3,647	12%
Medium (30-60°)	13,687	43%
High (60-80°)	13,833	44%
Very High (80-90°)	305	1%
Uplight (90-180°)	0	0%
Total Flux	31,472	100%

ISO Footcandle

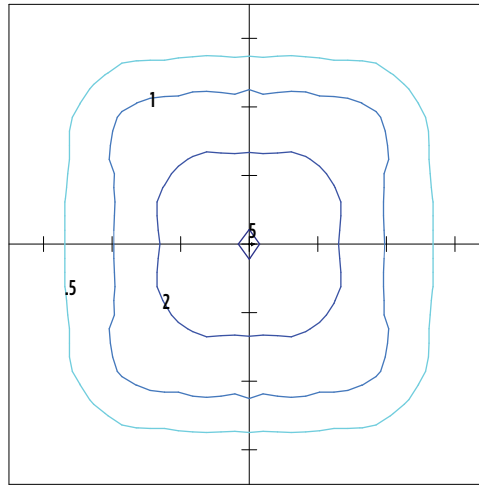

25' Mounting Height / 25' Grid Spacing
 5 FC 2 FC 1 FC 0.5 FC

Polar Curve

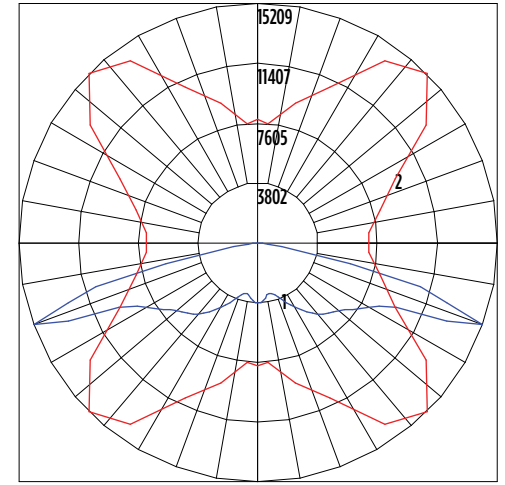

Vertical Plane Horizontal Cone

SLM-LED-30L-SIL-FTA-40-70CRI

Luminaire Data	
Type FTA Distribution	
Description	4000 Kelvin, 70 CRI
Delivered Lumens	30,535
Watts	213
Efficacy	143
IES Type	Type I - Very Short
BUG Rating	B4-U0-G3

Zonal Lumen Summary		
Zone	Lumens	% Luminaire
Low (0-30°)	7,443	25%
Medium (30-60°)	17,335	57%
High (60-80°)	5,324	17%
Very High (80-90°)	434	1%
Uplight (90-180°)	0	0%
Total Flux	30,535	100%

ISO Footcandle

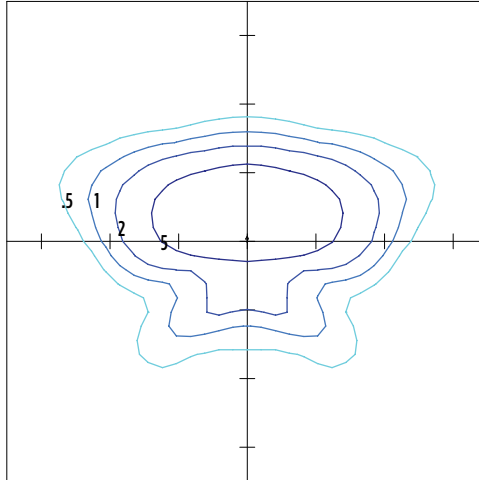

25' Mounting Height / 25' Grid Spacing
 5 FC 2 FC 1 FC 0.5 FC

Polar Curve

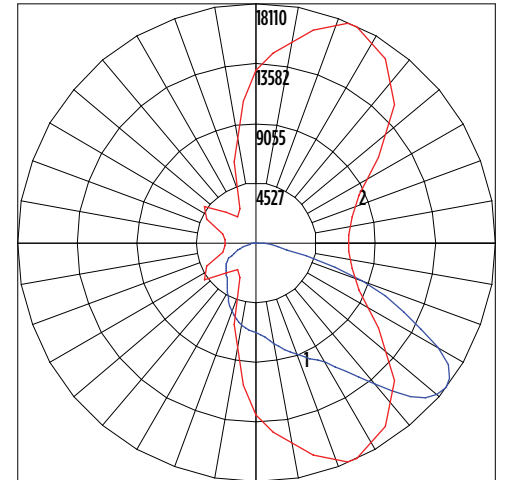

Vertical Plane Horizontal Cone

Slice Medium Outdoor LED Area Light

Type : _____

 Have questions? Call us at (800) 436-7800

PHOTOMETRICS (CONT.)

SLM-LED-30L-SIL-AM-40-70CRI

Luminaire Data	
Type AM Distribution	
Description	4000 Kelvin, 70 CRI
Delivered Lumens	31,820
Watts	213
Efficacy	149
IES Type	Type III - Very Short
BUG Rating	B3-U0-G3

Zonal Lumen Summary		
Zone	Lumens	% Luminaire
Low (0-30°)	6,626	21%
Medium (30-60°)	19,761	62%
High (60-80°)	5,072	16%
Very High (80-90°)	361	1%
Uplight (90-180°)	0	0%
Total Flux	31,820	100%

ISO Footcandle

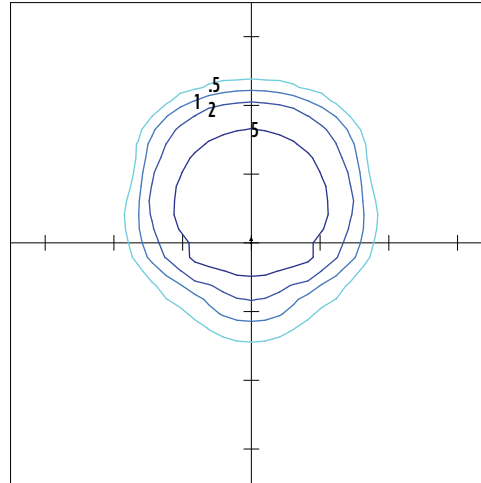

25' Mounting Height / 25' Grid Spacing
 5 FC 2 FC 1 FC 0.5 FC

Polar Curve

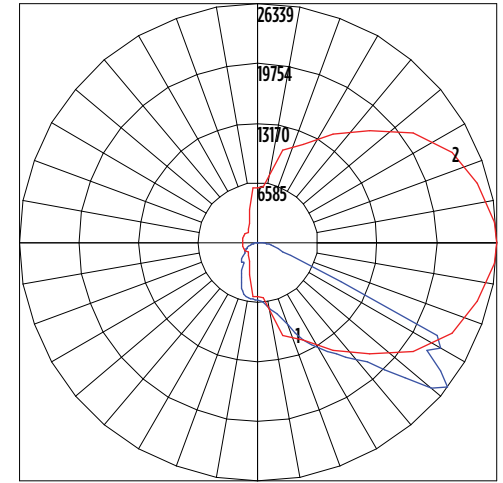

Vertical Plane Horizontal Cone

SLM-LED-30L-SIL-LC-40-70CRI

Luminaire Data	
Type LC Distribution	
Description	4000 Kelvin, 70 CRI
Delivered Lumens	31,891
Watts	213
Efficacy	150
IES Type	N/A
BUG Rating	B3-U0-G5

Zonal Lumen Summary		
Zone	Lumens	% Luminaire
Low (0-30°)	4965	16%
Medium (30-60°)	14179	44%
High (60-80°)	11730	37%
Very High (80-90°)	1018	3%
Uplight (90-180°)	0	0%
Total Flux	31891	100%

ISO Footcandle

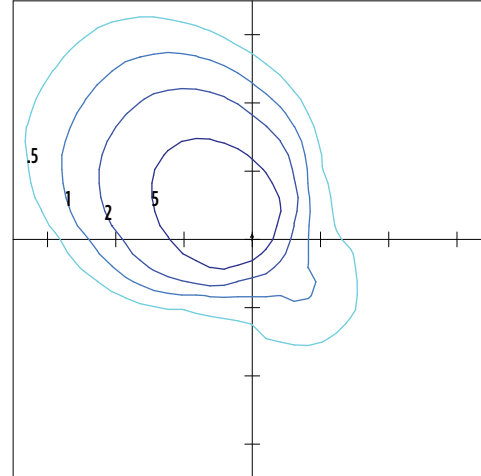

25' Mounting Height / 25' Grid Spacing
 5 FC 2 FC 1 FC 0.5 FC

Polar Curve

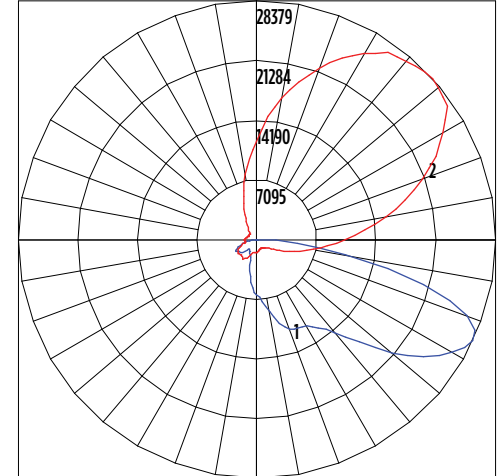

Vertical Plane Horizontal Cone

Slice Medium Outdoor LED Area Light

Type : _____

Have questions? Call us at (800) 436-7800

PHOTOMETRICS (CONT.)

SLM-LED-30L-SIL-RC-40-70CRI

Luminaire Data	
Type RC Distribution	
Description	4000 Kelvin, 70 CRI
Delivered Lumens	31,890
Watts	213
Efficacy	150
IES Type	N/A
BUG Rating	B3-U0-G5

Zonal Lumen Summary		
Zone	Lumens	% Luminaire
Low (0-30°)	4964	16%
Medium (30-60°)	14178	44%
High (60-80°)	11730	37%
Very High (80-90°)	1018	3%
Uplight (90-180°)	0	0%
Total Flux	31890	100%

ISO Footcandle

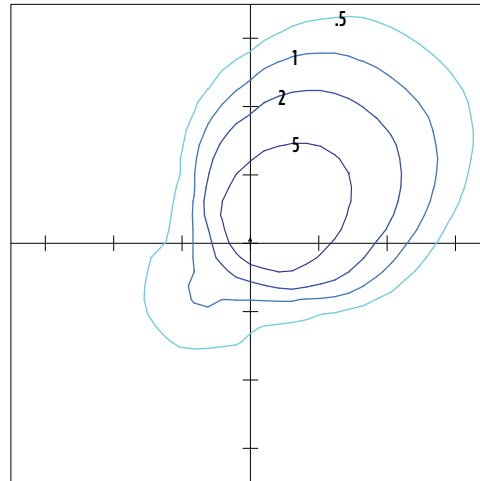

25' Mounting Height / 25' Grid Spacing
 5 FC 2 FC 1 FC 0.5 FC

Polar Curve

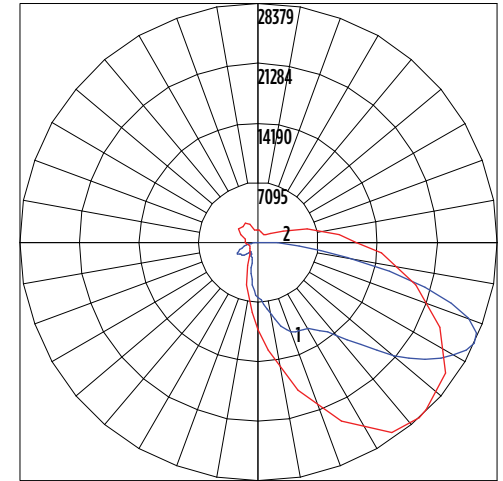

Vertical Plane Horizontal Cone

PRODUCT DIMENSIONS

[Back to Quick Links](#)

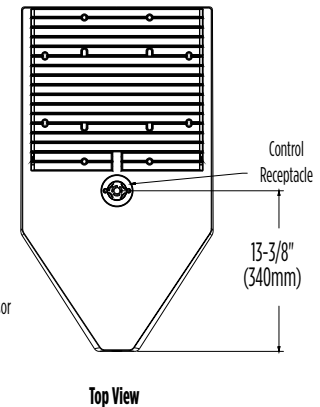
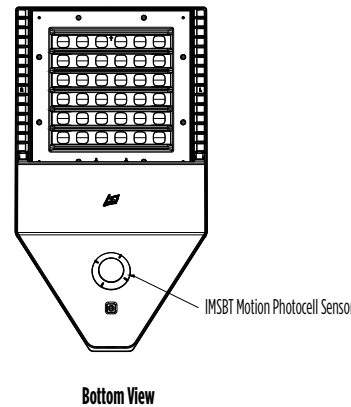
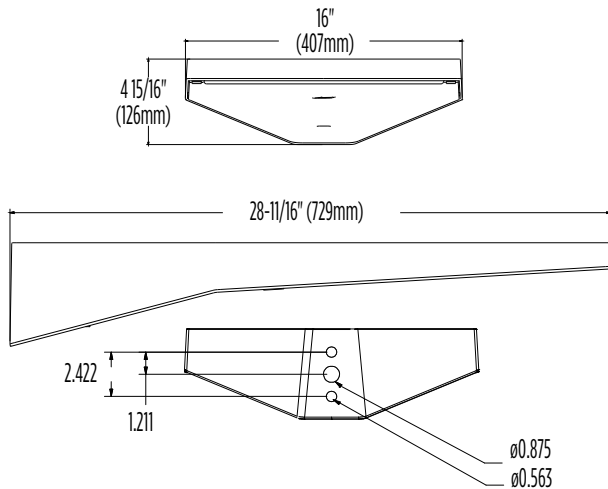

Luminaire EPA Chart					
Tilt Degree		0°	15°	30°	45°
	Single	0.5	1.2	2.1	2.6
	D180°	1.1	1.3	2.1	2.6
	D90°	0.9	1.8	2.5	3.1
	T90°	1.2	2.3	2.9	3.6
	TN120°	1.3	3.0	4.4	5.4
	Q90°	1.2	2.3	2.9	3.6

CONTROLS

[Back to Quick Links](#)

Integral Bluetooth™ Motion and Photocell Sensor (IMSBTxL)

Slim low profile sensor provides multi-level control based on motion and/or daylight. Sensor controls 0-10 VDC LED drivers and is IP66 rated for cold and wet locations (-40°F to 167°F). Two unique PIR lenses are available and used based on fixture mounting height. All control parameters are adjustable via an iOS or Android App capable of storing and transmitting sensor profiles.

[Click here to learn more details about IMSBT](#)



LEVITON App



Apple



Android

AirLink Blue (ALBMRxLR, ALBCSx)

Wireless Bluetooth Mesh Outdoor Lighting Control System that provides energy savings, code compliance and enhanced safety/security for parking lots and parking garages. Three key components; Bluetooth wireless radio/sensor controller, Time Keeper and an iOS App. Capable of grouping multiple fixtures and sensors as well as scheduling time-based events by zone. Radio/Sensor Controller is factory integrated into Area/Site, Wall Mounted, Parking Garage and Canopy luminaires.

[Click here to learn more details about AirLink Blue](#)



AirLink Blue App



Apple

Sensor Sequence of Operations

Standard Programming	On Event	Off Event	On Light Level	Dim Light Level	Daylight Harvesting	Delay To Off	Sensitivity
OMSBTxL/IMSBTxL	Motion	No Motion	100%	N/A	On; Auto Calibration	20 minutes	High
OMS	Motion	No Motion	N/A	N/A	N/A	30 seconds	Auto

Operation	Description
On Event	Trigger that activates lights to turn on; either automatic via motion detected or manually activated via push of button.
Off Event	Trigger that activates lights to turn off; either automatic via no motion detected or manually activated via push of button.
On Light Level	The light level that the fixtures will turn on to when ON EVENT occurs.
Dim Light Level	The light level that the fixtures will dim down to when no motion is detected.
Delay to Dim	The amount of time after which no motion is detected that the fixtures will be triggered to dim down. This sequence is optional, and sensor can be programmed to only trigger the fixture to turn off by entering 100% in this field.
Delay to Off	The amount of time after which no motion is detected that the fixtures will be triggered to turn off. If delay to dim is part of the programmed functionality, this is the amount of time after which no motion is detected after the fixture have already dimmed down.
Sensitivity	The sensitivity can be set to high, medium, low, or auto where applicable. High will detect smaller, simple motions. Low will only detect larger more complex motions. Auto temperature calibration adjusts the PIR sensitivity as ambient temperature rises to increase detection of heat movement through the field of view.