

SYLVANIA Luminaires

ValueLED™ UFO High Bay

Application

An environmentally preferable alternative to traditional luminaires and offering up to 78% energy savings, the ValueLED UFO High Bay is ideal for illuminating warehouses, gymnasiums, and other industrial applications.

Benefits and Features

- Lightweight, impact resistant fixture is designed for easy and safe installation
- Multiple mounting options for a variety of applications – pendant, loop, surface mount
- Variety of optics – polycarbonate refractor and aluminum reflector available
- IP65 rated aluminum body (standard finish is white)
- Up to 135 LPW
- 3500K, 4000K and 5000K color temperature
- CRI >80
- Offered in 100, 150, 200, and 240 watts

Electrical

- Designed to operate through 120-277V (UNV) or 347-480 (HUV) V_{AC} voltage
- Power Factor >90%
- THD <20%
- 0-10V
- Constant current LED driver with 4kV surge suppression

Rated Life

- ≥150,000 hours (L₇₀) @25°C

Warranty

- 5-year

Ambient Operating Range

- -40°F to +122°F (-40°C to +50°C) (100, 150 and 200W versions)
- -40°F to +113°F (-40°C to +45°C) (240W versions)

Certifications and Listings

- cULus
- RoHS
- FCC
- DLC Premium

Item #
Type
Project
Notes
Date



Wattage Comparison

Traditional Source	Traditional System Wattage	LED System Wattage	Energy Savings
250W MH	290	100	66%
250W HPS	295	100	66%
320W MH	370	150	59%
400W HPS	460	150	67%
400W MH	450	150	67%
750W MH	820	200	76%
750W HPS	840	200	76%
1000W MH	1080	240	78%
1000W HPS	1100	240	78%

Installation

- Luminaire mounts via hook (with 6' power cable and 3' dimming cable), pendant and surface mount options available
- Aluminum reflector and polycarbonate refractor also available



Ordering Guide

UFOHIBA	1A	/	XXX	XXX	D	8	XX	/	WH	/	-
Product Name	Generation		Wattage	Voltage	Dimming	CRI	Color Temp (CCT)		Color/Finish		Option
UFOHIBA =	1A		100 = 100 Watts	UNV = 120-277V	D = 0-10V	8 = >80	35 = 3500K		WH = White		blank = no option
UFO High Bay			150 = 150 Watts	HUV = 347-480V			40 = 4000K				M = Motion Sensor
			200 = 200 Watts				50 = 5000K				
			240 = 240 Watts								

Ordering Information

Item Number	Ordering Abbreviation	Wattage	Input Voltage	Dimming	CRI	Color Temp	Total Fixture Lumens (with Refractor Accessory)		Total Fixture Lumens (with Reflector Accessory)		DLC	Options	MTO*
							LPW	LPW	LPW	LPW			
61121	UFOHIBA1A/100UNVD835/WH	100	120-277	0-10	>80	3500K	13,800	133	13,100	126	Prm	-	MTO
61122	UFOHIBA1A/100UNVD840/WH	100	120-277	0-10	>80	4000K	13,800	133	13,100	126	Prm	-	
61123	UFOHIBA1A/100UNVD850/WH	100	120-277	0-10	>80	5000K	13,800	133	13,100	126	Prm	-	
61124	UFOHIBA1A/150UNVD835/WH	150	120-277	0-10	>80	3500K	20,300	135	19,200	127	Prm	-	MTO
61125	UFOHIBA1A/150UNVD840/WH	150	120-277	0-10	>80	4000K	20,300	135	19,200	127	Prm	-	
61126	UFOHIBA1A/150UNVD850/WH	150	120-277	0-10	>80	5000K	20,300	135	19,200	127	Prm	-	
61148	UFOHIBA1A/150UNVD835/WH/M	150	120-277	0-10	>80	3500K	20,300	135	19,200	127	Prm	Motion Sensor	MTO
61149	UFOHIBA1A/150UNVD840/WH/M	150	120-277	0-10	>80	4000K	20,300	135	19,200	127	Prm	Motion Sensor	MTO
61150	UFOHIBA1A/150UNVD850/WH/M	150	120-277	0-10	>80	5000K	20,300	135	19,200	127	Prm	Motion Sensor	MTO
61127	UFOHIBA1A/200UNVD835/WH	200	120-277	0-10	>80	3500K	26,000	130	26,000	127	Prm	-	MTO
61128	UFOHIBA1A/200UNVD840/WH	200	120-277	0-10	>80	4000K	26,000	130	26,000	127	Prm	-	
61129	UFOHIBA1A/200UNVD850/WH	200	120-277	0-10	>80	5000K	26,000	130	26,000	127	Prm	-	
61151	UFOHIBA1A/200UNVD835/WH/M	200	120-277	0-10	>80	3500K	26,000	130	26,000	127	Prm	Motion Sensor	MTO
61152	UFOHIBA1A/200UNVD840/WH/M	200	120-277	0-10	>80	4000K	26,000	130	26,000	127	Prm	Motion Sensor	MTO
61153	UFOHIBA1A/200UNVD850/WH/M	200	120-277	0-10	>80	5000K	26,000	130	26,000	127	Prm	Motion Sensor	MTO
61130	UFOHIBA1A/240UNVD835/WH	240	120-277	0-10	>80	3500K	31,300	132	30,300	127	Prm	-	MTO
61131	UFOHIBA1A/240UNVD840/WH	240	120-277	0-10	>80	4000K	31,300	132	30,300	127	Prm	-	
61132	UFOHIBA1A/240UNVD850/WH	240	120-277	0-10	>80	5000K	31,300	132	30,300	127	Prm	-	
61133	UFOHIBA1A/100HUV835/WH	100	347-480	0-10	>80	3500K	13,800	133	13,100	126	-	-	MTO
61134	UFOHIBA1A/100HUV840/WH	100	347-480	0-10	>80	4000K	13,800	133	13,100	126	-	-	
61135	UFOHIBA1A/100HUV850/WH	100	347-480	0-10	>80	5000K	13,800	133	13,100	126	-	-	
61136	UFOHIBA1A/150HUV835/WH	150	347-480	0-10	>80	3500K	20,300	135	19,200	127	-	-	MTO
61137	UFOHIBA1A/150HUV840/WH	150	347-480	0-10	>80	4000K	20,300	135	19,200	127	-	-	
61138	UFOHIBA1A/150HUV850/WH	150	347-480	0-10	>80	5000K	20,300	135	19,200	127	-	-	
61139	UFOHIBA1A/200HUV835/WH	200	347-480	0-10	>80	3500K	26,000	130	26,000	127	-	-	MTO
61140	UFOHIBA1A/200HUV840/WH	200	347-480	0-10	>80	4000K	26,000	130	26,000	127	-	-	
61141	UFOHIBA1A/200HUV850/WH	200	347-480	0-10	>80	5000K	26,000	130	26,000	127	-	-	
61142	UFOHIBA1A/240HUV835/WH	240	347-480	0-10	>80	3500K	31,300	132	30,300	127	-	-	MTO
61143	UFOHIBA1A/240HUV840/WH	240	347-480	0-10	>80	4000K	31,300	132	30,300	127	-	-	
61144	UFOHIBA1A/240HUV850/WH	240	347-480	0-10	>80	5000K	31,300	132	30,300	127	-	-	

*Made To Order

Photometric Data

Polycarbonate Refractor

Aluminum Reflector

100W

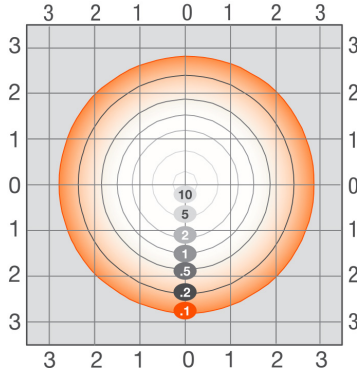

Isofootcandle Lines at 20' Mounting Height

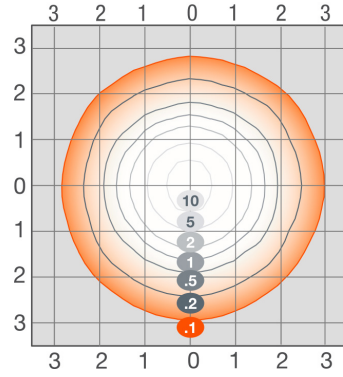

Isofootcandle Lines at 20' Mounting Height

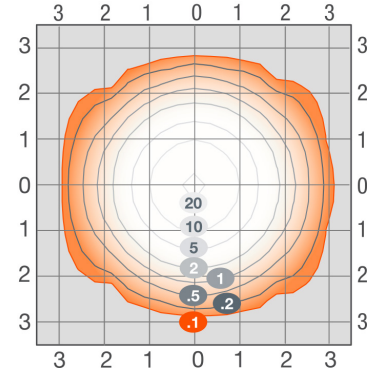

Isofootcandle Lines at 20' Mounting Height

150W

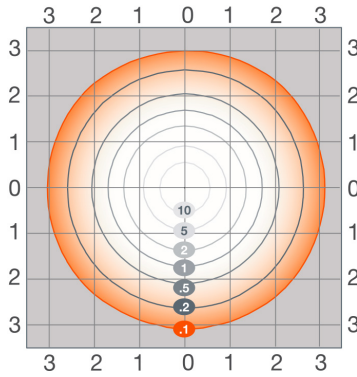

Isofootcandle Lines at 20' Mounting Height

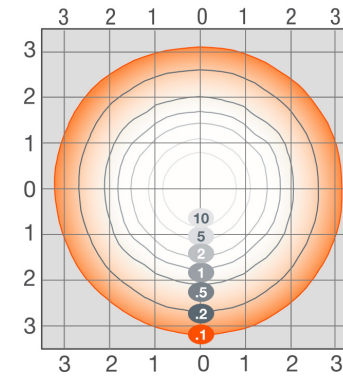

Isofootcandle Lines at 20' Mounting Height

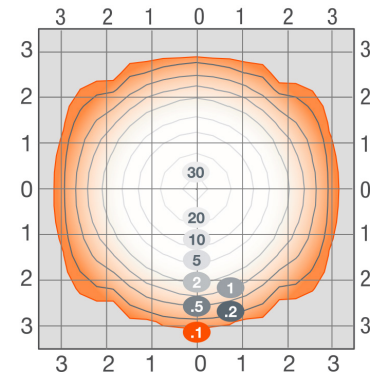

Isofootcandle Lines at 20' Mounting Height

200W

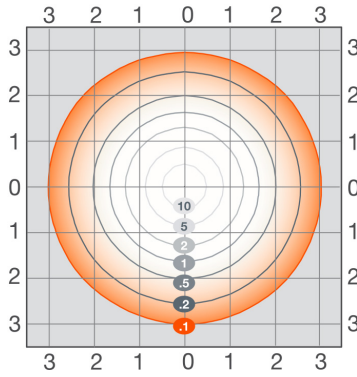

Isofootcandle Lines at 30' Mounting Height

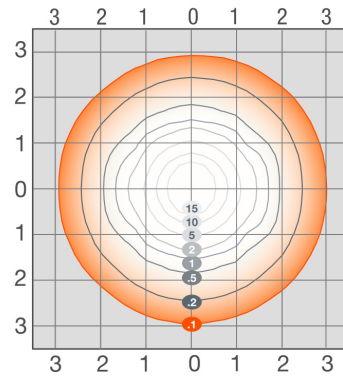

Isofootcandle Lines at 30' Mounting Height

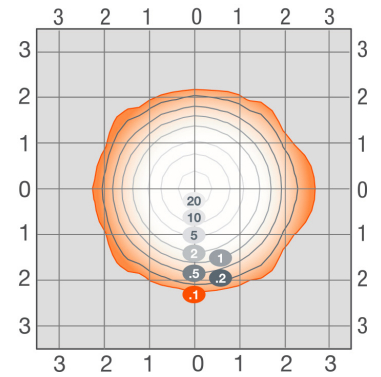

Isofootcandle Lines at 30' Mounting Height

240W

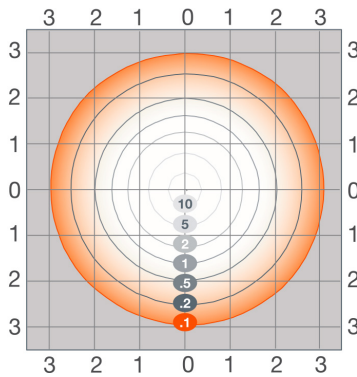

Isofootcandle Lines at 30' Mounting Height

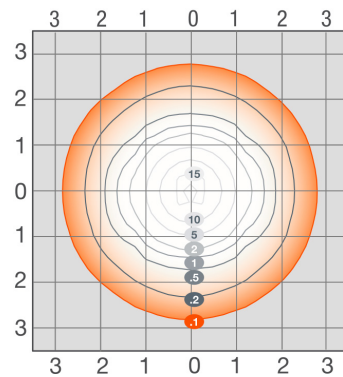

Isofootcandle Lines at 30' Mounting Height

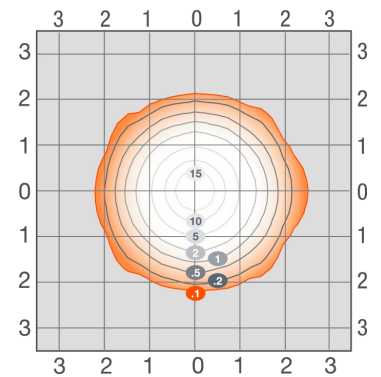

Isofootcandle Lines at 30' Mounting Height

Physical Information

Luminaire Description	Diameter	Height
100W	11.7"	7.3"
150W	11.7"	7.3"
200W	14.2"	8.5"
240W	14.2"	8.5"

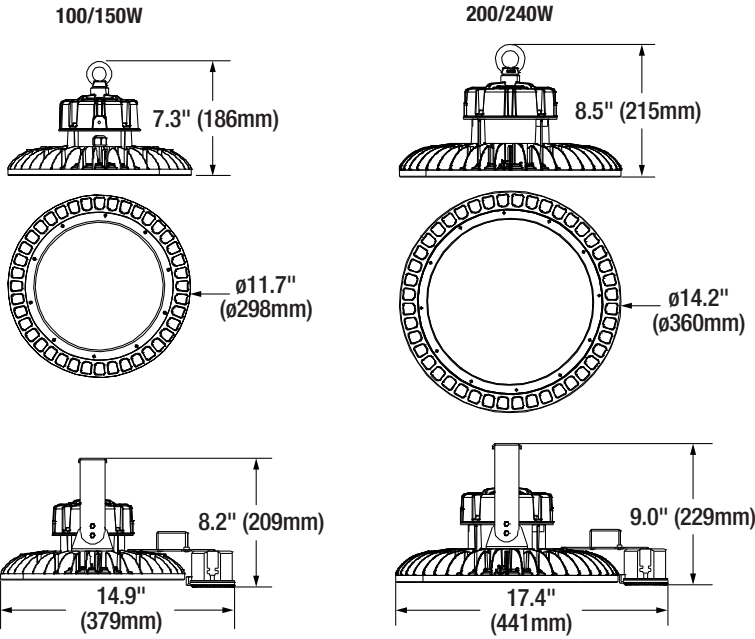

Accessories

Item Number	Ordering Abbreviation	Item Description
61428	UFOHIBA1A/PC1/T5	Polycarbonate refractor for 100 and 150W (type V distribution)
61429	UFOHIBA1A/PC2/T5	Polycarbonate refractor for 200 and 240W (type V distribution)
61430	UFOHIBA1A/AL1/90	Aluminum reflector for 100 and 150W (90° beam angle)
61431	UFOHIBA1A/AL2/90	Aluminum reflector for 200 and 240W (90° beam angle)
61432	UFOHIBA1A/BOTTOMLENS	Polycarbonate bottom lens

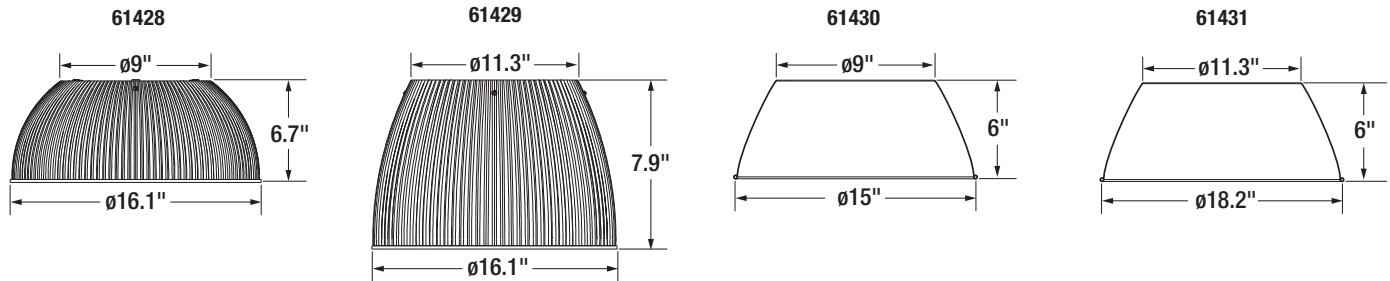

LEDVANCE LLC
 200 Ballardvale Street
 Wilmington, MA 01887 USA
 Phone 1-800-LIGHTBULB (1-800-544-4828)
 www.sylvania.com

SYLVANIA and LEDVANCE are registered trademarks.
 All other trademarks are those of their respective owners.
 Licensee of product trademark SYLVANIA in general lighting.
 Specifications subject to change without notice.

[/sylvania](https://twitter.com/sylvania) [/sylvania](https://facebook.com/sylvania)

© 2019 LEDVANCE LLC

Name: _____
 Email: _____
 Phone: _____

