

SYLVANIA Luminaires

ValueLED™ UFO 2A High Bay

Application

An environmentally preferable alternative to traditional luminaires and offering up to 78% energy savings, the ValueLED UFO 2A High Bay is ideal for illuminating warehouses, gymnasiums, and other industrial applications.

Benefits and Features

- Lightweight fixture is designed for easy and safe installation
- NSF Splash Zone rated
- Multiple mounting options for a variety of applications – pendant, hook, surface mount
- All fixtures ship with a sensor base pre-wired to a small junction box so they are ready to accept the optional, field installable, screw-in microwave motion/daylight sensor with no wiring required – sensor installs in seconds
- Mounting hook included
- 90° polycarbonate front lens minimizes glare
- Variety of optics – polycarbonate refractor and aluminum reflector available
- IP65 rated aluminum body (finish is white or black)
- Up to 145 LPW
- 4000K and 5000K color temperatures
- CRI >80
- Offered in 100, 150, 200, and 240 watts

Electrical

- Designed to operate through 120-277V (UNV) or 277-480 (HUV) V_{AC} voltage
- Power Factor >90%
- THD <20%
- 0-10V dimming
- Constant current LED driver with 6kV surge suppression
- UL Wet Rated

Rated Life

- ≥150,000 hours (L₇₀) @25°C

Warranty

- 5-year
- NLB Trusted Warranty Program

Ambient Operating Range

- -40°F to +122°F (-40°C to +50°C)

Item #
Type
Project
Notes
Date



Wattage Comparison

Traditional Source	Traditional System Wattage	LED System Wattage	Energy Savings
250W MH	290	100	66%
250W HPS	295	100	66%
320W MH	370	150	59%
400W HPS	460	150	67%
400W MH	450	150	67%
750W MH	820	200	76%
750W HPS	840	200	76%
1000W MH	1080	240	78%
1000W HPS	1100	240	78%

Certifications and Listings

- cULus
- RoHS
- FCC
- NSF
- DLC 5.1 Premium

Installation

- Luminaire can be hung via included hook, or can be surface or pendant mounted using optional mounting brackets.
- Aluminum reflector, polycarbonate refractor, and polycarbonate bottoms lens are available.
- Includes 6' power cable and 3' dimming cable.
- Polycarbonate refractor and polycarbonate bottom lens have an IK08 rating.
- Optional wire guards are available
- Unscrew plug in the center of the lens to screw in the optional motion/daylight sensor by hand – no wiring required



Ordering Guide

UFOHIBA	2A	/	XXX	XXX	D	8	XX	/	XX
Product Name	Generation		Wattage	Voltage	Dimming	CRI	Color Temp (CCT)		Color/Finish
UFOHIBA =	2A		100 = 100 Watts	UNV = 120-277V	D = 0-10V	8 = >80	40 = 4000K		WH = White
UFO High Bay			150 = 150 Watts	HUV = 277-480V			50 = 5000K		BL = Black
			200 = 200 Watts						
			240 = 240 Watts						

Ordering Information

Item Number	Ordering Abbreviation	Wattage	Input Voltage	Dimming	CRI	CCT	Total Fixture Lumens	LPW	DLC
62069	UFOHIBA2A/100UNVD840/WH	100	120-277	0-10V	>80	4000K	14,200	142	Prm
62320	UFOHIBA2A/100UNVD840/BL	100	120-277	0-10V	>80	4000K	14,200	142	Prm
62070	UFOHIBA2A/100UNVD850/WH	100	120-277	0-10V	>80	5000K	14,400	144	Prm
62321	UFOHIBA2A/100UNVD850/BL	100	120-277	0-10V	>80	5000K	14,400	144	Prm
62072	UFOHIBA2A/150UNVD840/WH	150	120-277	0-10V	>80	4000K	21,300	142	Prm
62322	UFOHIBA2A/150UNVD840/BL	150	120-277	0-10V	>80	4000K	21,300	142	Prm
62073	UFOHIBA2A/150UNVD850/WH	150	120-277	0-10V	>80	5000K	21,600	144	Prm
62323	UFOHIBA2A/150UNVD850/BL	150	120-277	0-10V	>80	5000K	21,600	144	Prm
62075	UFOHIBA2A/200UNVD840/WH	200	120-277	0-10V	>80	4000K	28,400	142	Prm
62324	UFOHIBA2A/200UNVD840/BL	200	120-277	0-10V	>80	4000K	28,400	142	Prm
62076	UFOHIBA2A/200UNVD850/WH	200	120-277	0-10V	>80	5000K	28,800	144	Prm
62325	UFOHIBA2A/200UNVD850/BL	200	120-277	0-10V	>80	5000K	28,800	144	Prm
62078	UFOHIBA2A/240UNVD840/WH	240	120-277	0-10V	>80	4000K	34,080	142	Prm
62326	UFOHIBA2A/240UNVD840/BL	240	120-277	0-10V	>80	4000K	34,080	142	Prm
62079	UFOHIBA2A/240UNVD850/WH	240	120-277	0-10V	>80	5000K	34,560	144	Prm
62327	UFOHIBA2A/240UNVD850/BL	240	120-277	0-10V	>80	5000K	34,560	144	Prm
62081	UFOHIBA2A/100HUV840/WH	100	277-480	0-10V	>80	4000K	14,300	143	Prm
62328	UFOHIBA2A/100HUV840/BL	100	277-480	0-10V	>80	4000K	14,300	143	Prm
62082	UFOHIBA2A/100HUV850/WH	100	277-480	0-10V	>80	5000K	14,500	145	Prm
62329	UFOHIBA2A/100HUV850/BL	100	277-480	0-10V	>80	5000K	14,500	145	Prm
62084	UFOHIBA2A/150HUV840/WH	150	277-480	0-10V	>80	4000K	21,450	143	Prm
62330	UFOHIBA2A/150HUV840/BL	150	277-480	0-10V	>80	4000K	21,450	143	Prm
62085	UFOHIBA2A/150HUV850/WH	150	277-480	0-10V	>80	5000K	21,750	145	Prm
62331	UFOHIBA2A/150HUV850/BL	150	277-480	0-10V	>80	5000K	21,750	145	Prm
62087	UFOHIBA2A/200HUV840/WH	200	277-480	0-10V	>80	4000K	28,600	143	Prm
62332	UFOHIBA2A/200HUV840/BL	200	277-480	0-10V	>80	4000K	28,600	143	Prm
62088	UFOHIBA2A/200HUV850/WH	200	277-480	0-10V	>80	5000K	29,000	145	Prm
62333	UFOHIBA2A/200HUV850/BL	200	277-480	0-10V	>80	5000K	29,000	145	Prm
62090	UFOHIBA2A/240HUV840/WH	240	277-480	0-10V	>80	4000K	34,320	143	Prm
62334	UFOHIBA2A/240HUV840/BL	240	277-480	0-10V	>80	4000K	34,320	143	Prm
62091	UFOHIBA2A/240HUV850/WH	240	277-480	0-10V	>80	5000K	34,800	145	Prm
62335	UFOHIBA2A/240HUV850/BL	240	277-480	0-10V	>80	5000K	34,800	145	Prm

Physical Information

Luminaire Description	Diameter	Height
100W/150W	11.81"	8.27"
200W/240W	14.17"	8.82"

100/150W

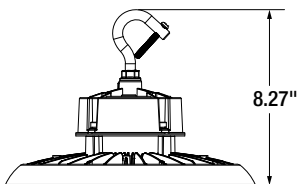

200/240W

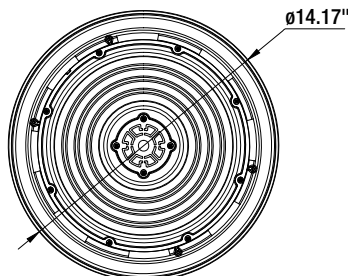
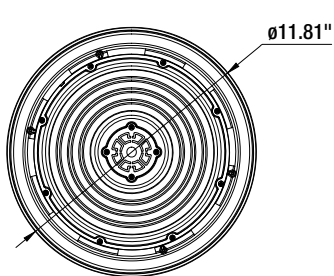
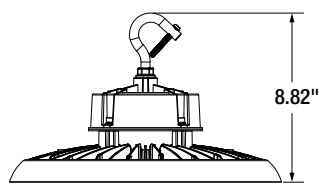

Photometric Information

100W UNV

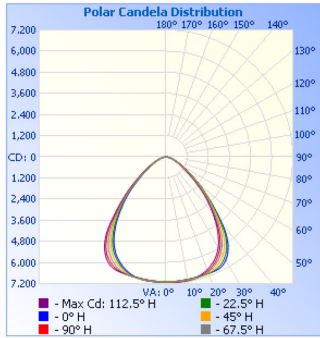

100W HUV

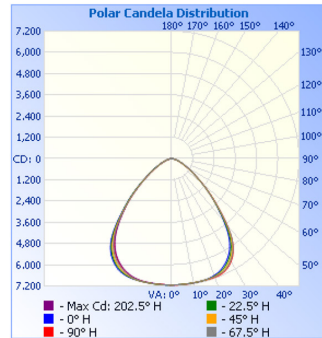

150W UNV

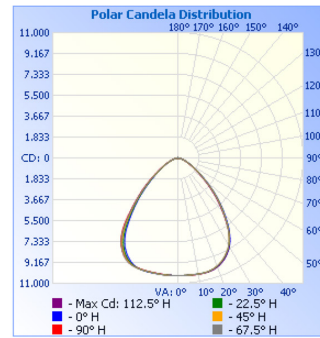

150W HUV

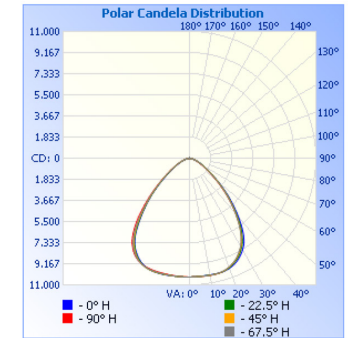

200W UNV

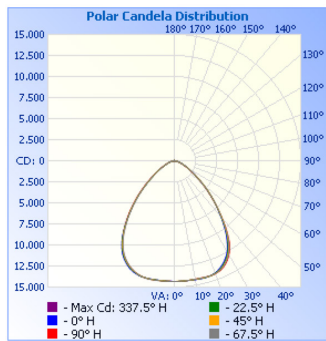

200W HUV

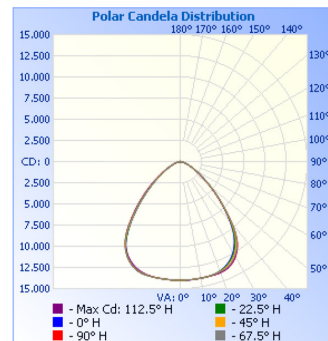

240W UNV

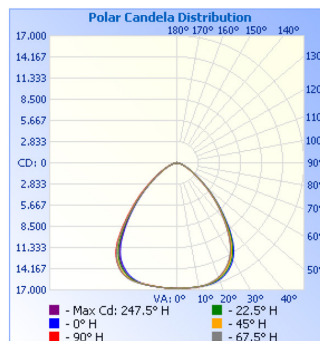

240W HUV

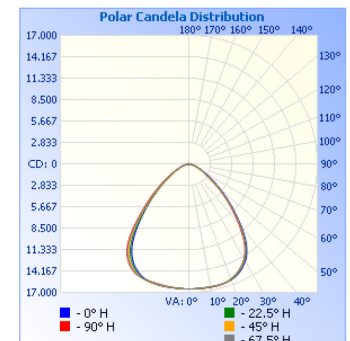

Illuminance Information

100W UNV

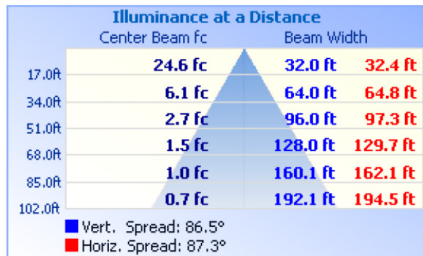

100W HUV

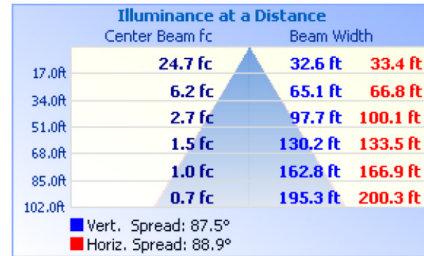

150W UNV

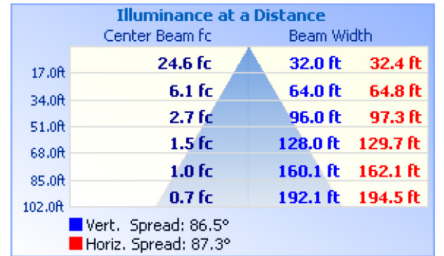

150W HUV

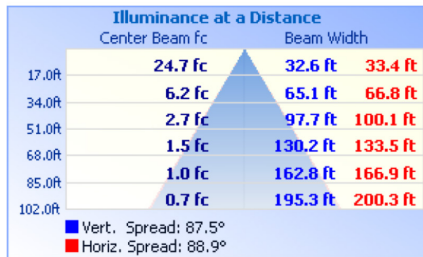

200W UNV

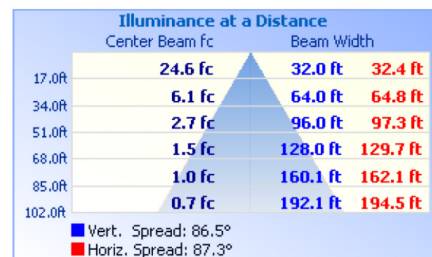

200W HUV

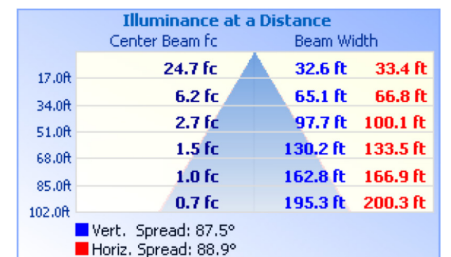

240W UNV

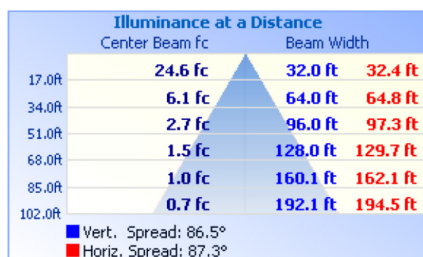

240W HUV

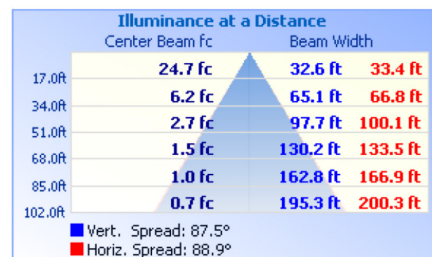

Accessories

Item Number	Ordering Abbreviation	Item Description
65613	UFOHIBA2A/SURFPENDMNT1/WH	White Surface/Pendant Mount Bracket for 100-150W products
65614	UFOHIBA2A/SURFPENDMNT2/WH	White Surface/Pendant Mount Bracket for 200-240W products
65702	UFOHIBA2A/SURFPENDMNT1/BL	Black Surface/Pendant Mount Bracket for 100-150W products
65703	UFOHIBA2A/SURFPENDMNT2/BL	Black Surface/Pendant Mount Bracket for 200-240W products
65620	UFOHIBA2A/WG1/WH	Wire guard for 100-150W products
65621	UFOHIBA2A/WG2/WH	Wire guard for 200-240W products
65622	HIGHBAY/MOTIONDAYSENSOR	Field installable DC Motion/Daylight Sensor, IP65
65623	REMOTE/MOTIONDAY/001	Remote control for Motion/Daylight Sensor – Remote is Required to change default settings
65616	UFOHIBA2A/PC1/90	Polycarbonate Refractor for 100-150W products, 90° distribution
65617	UFOHIBA2A/PC2/90	Polycarbonate Refractor for 200-240W products, 90° distribution
61432	UFOHIBA1A/BOTTOMLENS	Polycarbonate bottom lens for use with 65616 or 65617
65618	UFOHIBA2A/AL1/90	Aluminum Reflector for 100-150W products, 90° distribution
65619	UFOHIBA2A/AL2/90	Aluminum Reflector for 200-240W products, 90° distribution
61062	EMBB/UFO/40WDC	Field installable emergency battery back-up unit, ensuring at least 90 minutes of light output in case of power failure. All units ship with a remote control facilitating the testing of the units.

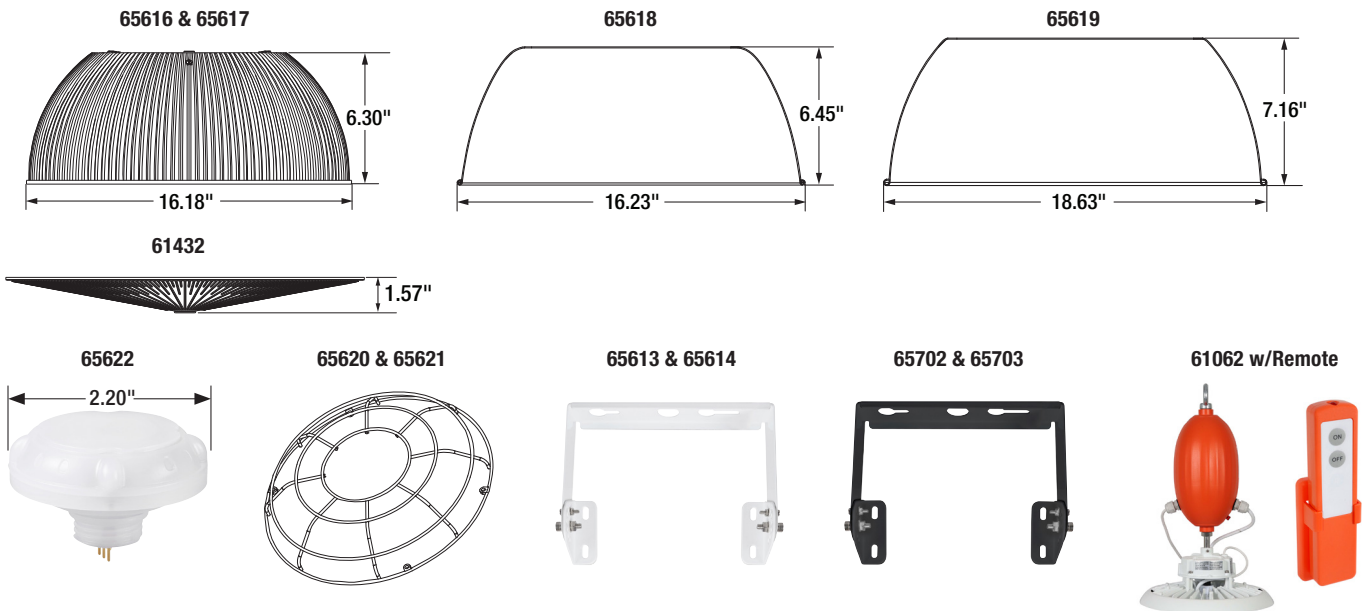

Optional Motion/Daylight Sensor Default Settings*

Detection area	100%
Hold time – Time fixture stays at 100% after last motion before dimming	5 Minutes
Daylight threshold – light level above which light will remain off	50 Lux
Stand-by period – Time light remains dimmed before shutting off	60 Minutes
Stand-by dimming – Dimming level of light during stand-by period	30%

*The default settings can only be changed using the optional remote 65623.

LEDVANCE LLC
 200 Ballardvale Street
 Wilmington, MA 01887 USA
 Phone 1-800-LIGHTBULB (1-800-544-4828)
 www.ledvanceUS.com

Name: _____

Email: _____

Phone: _____

SYLVANIA and LEDVANCE are registered trademarks.
 All other trademarks are those of their respective owners.
 Licensee of product trademark SYLVANIA in general lighting.
 Specifications subject to change without notice.

[/sylvania](#) [/sylvania](#)

