

# SYLVANIA Luminaires

## ValueLED™ UFO 2A High Bay

### Application

An environmentally preferable alternative to traditional luminaires and offering up to 78% energy savings, the ValueLED UFO 2A High Bay is ideal for illuminating warehouses, gymnasiums, and other industrial applications.

### Benefits and Features

- Lightweight fixture is designed for easy and safe installation
- NSF Splash Zone rated
- Multiple mounting options for a variety of applications – pendant, hook, surface mount
- All fixtures ship with a sensor base pre-wired to a small junction box so they are ready to accept the optional, field installable, screw-in microwave motion/daylight sensor with no wiring required – sensor installs in seconds
- Mounting hook included
- 90° polycarbonate front lens minimizes glare
- Variety of optics – polycarbonate refractor and aluminum reflector available
- IP65 rated aluminum body (finish is white or black)
- Up to 145 LPW
- 4000K and 5000K color temperatures
- CRI >80
- Offered in 100, 150, 200, and 240 watts

### Electrical

- Designed to operate through 120-277V (UNV) or 277-480 (HUV) V<sub>AC</sub> voltage
- Power Factor >90%
- THD <20%
- 0-10V dimming
- Constant current LED driver with 6kV surge suppression
- UL Wet Rated

### Rated Life

- ≥150,000 hours (L<sub>70</sub>) @25°C

### Warranty

- 5-year
- NLB Trusted Warranty Program

### Ambient Operating Range

- -40°F to +122°F (-40°C to +50°C)

Item #
Type
Project
Notes
Date



### Wattage Comparison

Traditional Source	Traditional System Wattage	LED System Wattage	Energy Savings
250W MH	290	100	66%
250W HPS	295	100	66%
320W MH	370	150	59%
400W HPS	460	150	67%
400W MH	450	150	67%
750W MH	820	200	76%
750W HPS	840	200	76%
1000W MH	1080	240	78%
1000W HPS	1100	240	78%

### Certifications and Listings

- cULus
- RoHS
- FCC
- NSF
- DLC 5.1 Premium

### Installation

- Luminaire can be hung via included hook, or can be surface or pendant mounted using optional mounting brackets.
- Aluminum reflector, polycarbonate refractor, and polycarbonate bottoms lens are available.
- Includes 6' power cable and 3' dimming cable.
- Polycarbonate refractor and polycarbonate bottom lens have an IK08 rating.
- Optional wire guards are available
- Unscrew plug in the center of the lens to screw in the optional motion/daylight sensor by hand – no wiring required



## Ordering Guide

UFOHIBA	2A	/	XXX	XXX	D	8	XX	/	XX
Product Name	Generation		Wattage	Voltage	Dimming	CRI	Color Temp (CCT)		Color/Finish
UFOHIBA =	2A		100 = 100 Watts	UNV = 120-277V	D = 0-10V	8 = >80	40 = 4000K		WH = White
UFO High Bay			150 = 150 Watts	HUV = 277-480V			50 = 5000K		BL = Black
			200 = 200 Watts						
			240 = 240 Watts						

## Ordering Information

Item Number	Ordering Abbreviation	Wattage	Input Voltage	Dimming	CRI	CCT	Total Fixture Lumens	LPW	DLC
62069	UFOHIBA2A/100UNVD840/WH	100	120-277	0-10V	>80	4000K	14,200	142	Prm
62320	UFOHIBA2A/100UNVD840/BL	100	120-277	0-10V	>80	4000K	14,200	142	Prm
62070	UFOHIBA2A/100UNVD850/WH	100	120-277	0-10V	>80	5000K	14,400	144	Prm
62321	UFOHIBA2A/100UNVD850/BL	100	120-277	0-10V	>80	5000K	14,400	144	Prm
62072	UFOHIBA2A/150UNVD840/WH	150	120-277	0-10V	>80	4000K	21,300	142	Prm
62322	UFOHIBA2A/150UNVD840/BL	150	120-277	0-10V	>80	4000K	21,300	142	Prm
62073	UFOHIBA2A/150UNVD850/WH	150	120-277	0-10V	>80	5000K	21,600	144	Prm
62323	UFOHIBA2A/150UNVD850/BL	150	120-277	0-10V	>80	5000K	21,600	144	Prm
62075	UFOHIBA2A/200UNVD840/WH	200	120-277	0-10V	>80	4000K	28,400	142	Prm
62324	UFOHIBA2A/200UNVD840/BL	200	120-277	0-10V	>80	4000K	28,400	142	Prm
62076	UFOHIBA2A/200UNVD850/WH	200	120-277	0-10V	>80	5000K	28,800	144	Prm
62325	UFOHIBA2A/200UNVD850/BL	200	120-277	0-10V	>80	5000K	28,800	144	Prm
62078	UFOHIBA2A/240UNVD840/WH	240	120-277	0-10V	>80	4000K	34,080	142	Prm
62326	UFOHIBA2A/240UNVD840/BL	240	120-277	0-10V	>80	4000K	34,080	142	Prm
62079	UFOHIBA2A/240UNVD850/WH	240	120-277	0-10V	>80	5000K	34,560	144	Prm
62327	UFOHIBA2A/240UNVD850/BL	240	120-277	0-10V	>80	5000K	34,560	144	Prm
62081	UFOHIBA2A/100HUV840/WH	100	277-480	0-10V	>80	4000K	14,300	143	Prm
62328	UFOHIBA2A/100HUV840/BL	100	277-480	0-10V	>80	4000K	14,300	143	Prm
62082	UFOHIBA2A/100HUV850/WH	100	277-480	0-10V	>80	5000K	14,500	145	Prm
62329	UFOHIBA2A/100HUV850/BL	100	277-480	0-10V	>80	5000K	14,500	145	Prm
62084	UFOHIBA2A/150HUV840/WH	150	277-480	0-10V	>80	4000K	21,450	143	Prm
62330	UFOHIBA2A/150HUV840/BL	150	277-480	0-10V	>80	4000K	21,450	143	Prm
62085	UFOHIBA2A/150HUV850/WH	150	277-480	0-10V	>80	5000K	21,750	145	Prm
62331	UFOHIBA2A/150HUV850/BL	150	277-480	0-10V	>80	5000K	21,750	145	Prm
62087	UFOHIBA2A/200HUV840/WH	200	277-480	0-10V	>80	4000K	28,600	143	Prm
62332	UFOHIBA2A/200HUV840/BL	200	277-480	0-10V	>80	4000K	28,600	143	Prm
62088	UFOHIBA2A/200HUV850/WH	200	277-480	0-10V	>80	5000K	29,000	145	Prm
62333	UFOHIBA2A/200HUV850/BL	200	277-480	0-10V	>80	5000K	29,000	145	Prm
62090	UFOHIBA2A/240HUV840/WH	240	277-480	0-10V	>80	4000K	34,320	143	Prm
62334	UFOHIBA2A/240HUV840/BL	240	277-480	0-10V	>80	4000K	34,320	143	Prm
62091	UFOHIBA2A/240HUV850/WH	240	277-480	0-10V	>80	5000K	34,800	145	Prm
62335	UFOHIBA2A/240HUV850/BL	240	277-480	0-10V	>80	5000K	34,800	145	Prm

## Physical Information

Luminaire Description	Diameter	Height
100W/150W	11.81"	8.27"
200W/240W	14.17"	8.82"

### 100/150W

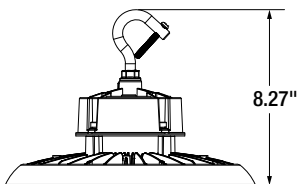

### 200/240W

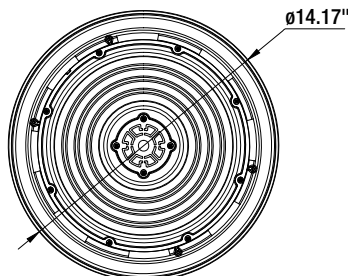
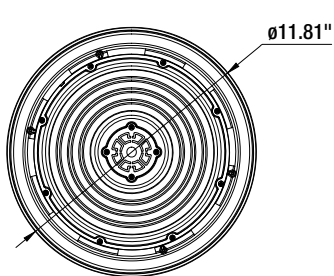
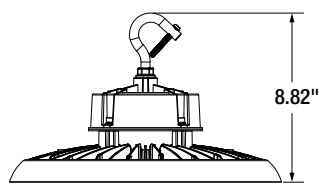

## Photometric Information

### 100W UNV

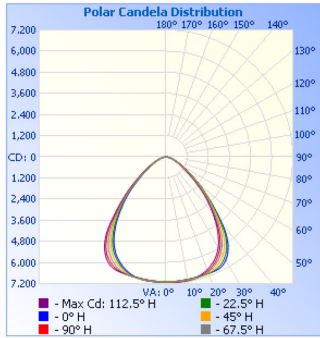

### 100W HUV

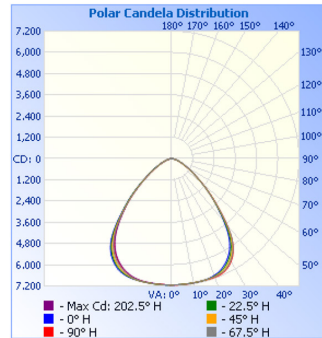

### 150W UNV

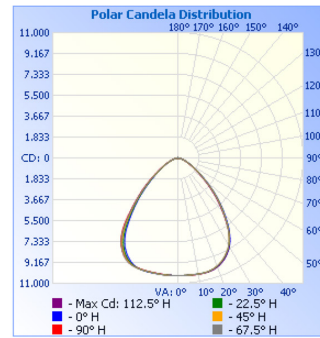

### 150W HUV

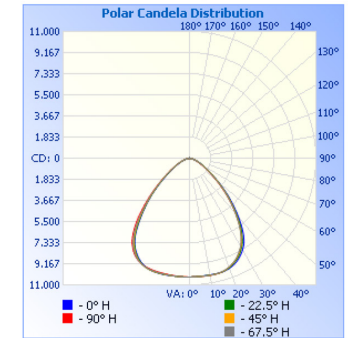

### 200W UNV

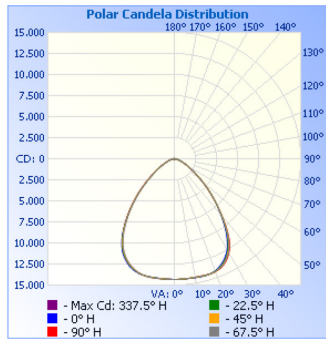

### 200W HUV

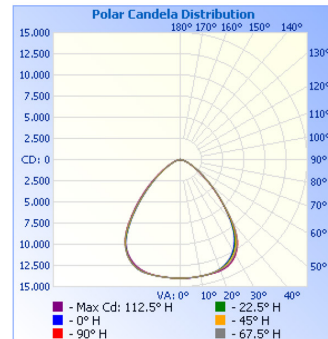

### 240W UNV

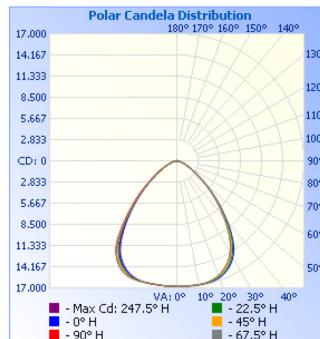

### 240W HUV

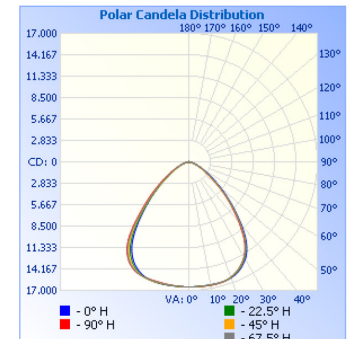

## Illuminance Information

### 100W UNV

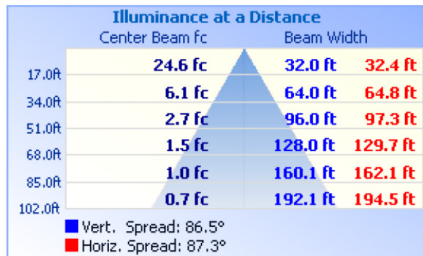

### 100W HUV

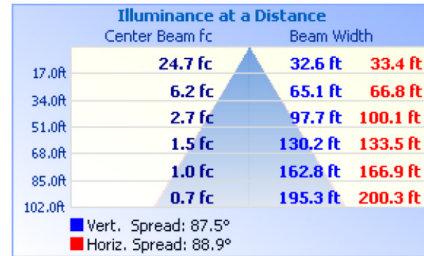

### 150W UNV

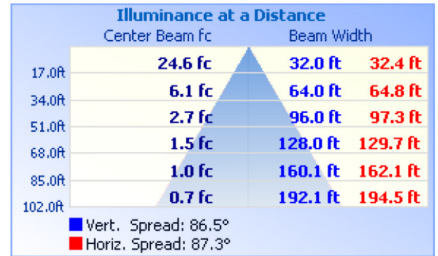

### 150W HUV

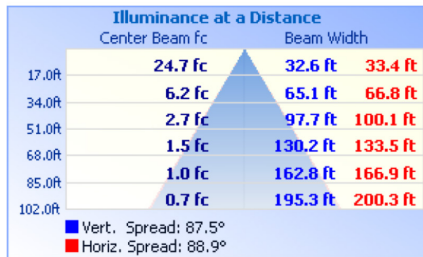

### 200W UNV

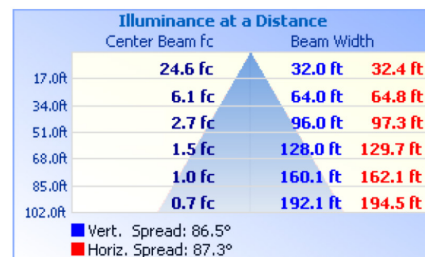

### 200W HUV

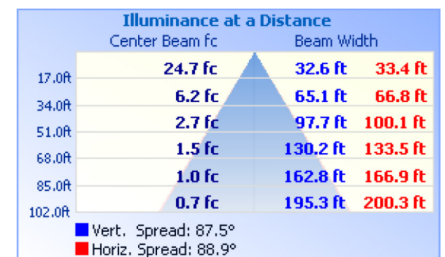

### 240W UNV

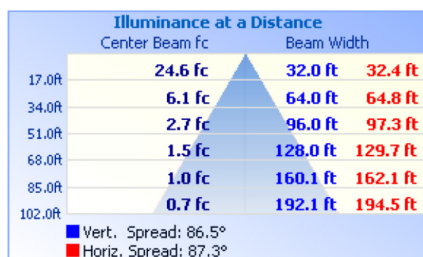

### 240W HUV

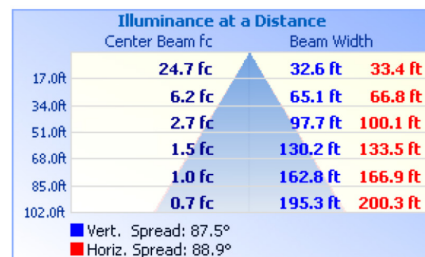

## Accessories

Item Number	Ordering Abbreviation	Item Description
65613	UFOHIBA2A/SURFPENDMNT1/WH	White Surface/Pendant Mount Bracket for 100-150W products
65614	UFOHIBA2A/SURFPENDMNT2/WH	White Surface/Pendant Mount Bracket for 200-240W products
65702	UFOHIBA2A/SURFPENDMNT1/BL	Black Surface/Pendant Mount Bracket for 100-150W products
65703	UFOHIBA2A/SURFPENDMNT2/BL	Black Surface/Pendant Mount Bracket for 200-240W products
65620	UFOHIBA2A/WG1/WH	Wire guard for 100-150W products
65621	UFOHIBA2A/WG2/WH	Wire guard for 200-240W products
65622	HIGHBAY/MOTIONDAYSENSOR	Field installable DC Motion/Daylight Sensor, IP65
65623	REMOTE/MOTIONDAY/001	Remote control for Motion/Daylight Sensor – Remote is Required to change default settings
65616	UFOHIBA2A/PC1/90	Polycarbonate Refractor for 100-150W products, 90° distribution
65617	UFOHIBA2A/PC2/90	Polycarbonate Refractor for 200-240W products, 90° distribution
61432	UFOHIBA1A/BOTTOMLENS	Polycarbonate bottom lens for use with 65616 or 65617
65618	UFOHIBA2A/AL1/90	Aluminum Reflector for 100-150W products, 90° distribution
65619	UFOHIBA2A/AL2/90	Aluminum Reflector for 200-240W products, 90° distribution
61062	EMBB/UFO/40WDC	Field installable emergency battery back-up unit, ensuring at least 90 minutes of light output in case of power failure. All units ship with a remote control facilitating the testing of the units.

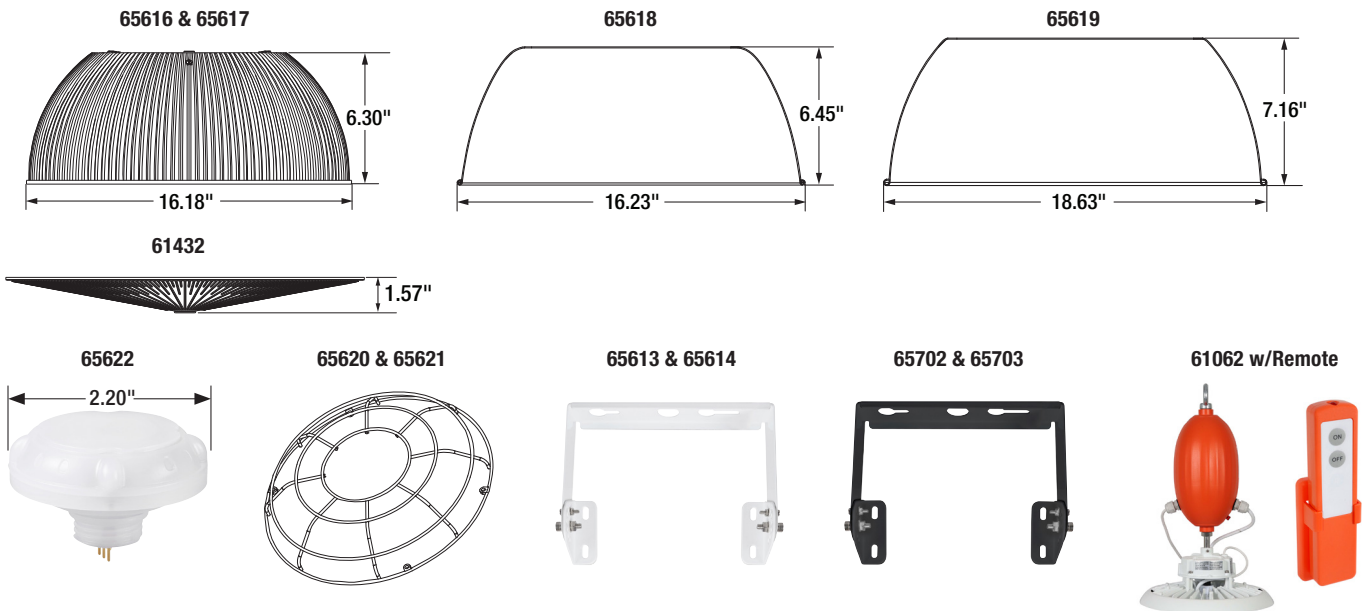

## Optional Motion/Daylight Sensor Default Settings\*

<b>Detection area</b>	100%
<b>Hold time – Time fixture stays at 100% after last motion before dimming</b>	5 Minutes
<b>Daylight threshold – light level above which light will remain off</b>	50 Lux
<b>Stand-by period – Time light remains dimmed before shutting off</b>	60 Minutes
<b>Stand-by dimming – Dimming level of light during stand-by period</b>	30%

\*The default settings can only be changed using the optional remote 65623.

LEDVANCE LLC  
 200 Ballardvale Street  
 Wilmington, MA 01887 USA  
 Phone 1-800-LIGHTBULB (1-800-544-4828)  
 www.ledvanceUS.com

SYLVANIA and LEDVANCE are registered trademarks.  
 All other trademarks are those of their respective owners.  
 Licensee of product trademark SYLVANIA in general lighting.  
 Specifications subject to change without notice.

[/sylvania](#) [/sylvania](#)

Name: \_\_\_\_\_  
 Email: \_\_\_\_\_  
 Phone: \_\_\_\_\_

