

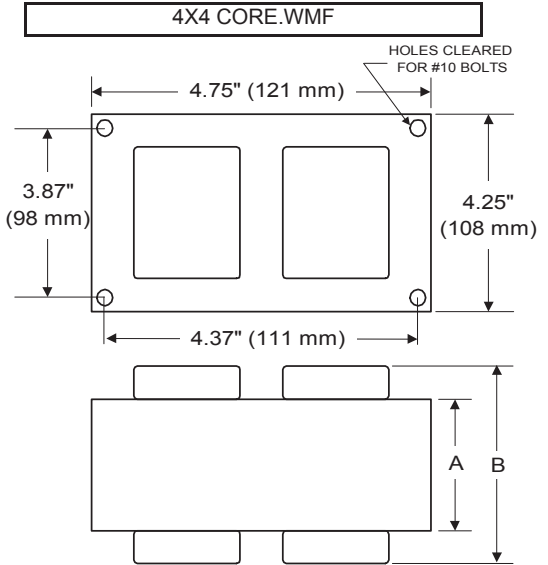

BALLAST SPECIFICATION

575W M178
Pulse Start Metal Halide
V90D5510
60 Hz CWA C&C

Input Volts	120	208	240	277
Line Current (Amps)				
Operating	5.65	3.15	2.85	2.45
Open Circuit	2.30	1.20	1.20	1.00
Starting	5.10	2.90	2.60	2.30
Recommended Fuse (Amps)	15	8	7	6
Regulation				
Line Volts	±10%	±10%	±10%	±10%
Lamp Watts	±9%	±9%	±9%	±9%
Temperature Ratings				
Insulation Class	180 (H)	180 (H)	180 (H)	180 (H)
Coil Temperature Code	C	C	D	D
Benchtop Coil Rise	83.3	83.8	89.2	86.9
Power Factor (%) HPF	90	90	90	90
Input Watts	640 W	640 W	640 W	640 W
Efficiency	89.0%	89.0%	89.0%	89.0%
NOM. Open Circuit Voltage	280	280	280	280
Input Voltage At Lamp Dropout	70	120	130	150
Min Ambient Starting Temp	-20°F/-30°C*	-20°F/-30°C*	-20°F/-30°C*	-20°F/-30°C*
60 HZ TEST PROCEDURES				
High Potential Test (Volts)				
1 Minute	1,600 V	1,600 V	1,600 V	1,600 V
1 Second	1,900 V	1,900 V	1,900 V	1,900 V
Open Circuit Voltage Test (V)	260 - 300	260 - 300	260 - 300	260 - 300
Short Circuit Current Test (A)				
Secondary Current				
Min	5.20	5.20	5.20	5.20
Max	6.30	6.30	6.30	6.30
Input Current				
Min	4.05	2.30	2.10	1.85
Max	6.10	3.50	3.10	2.70
CORE and COIL Specifications				
Dimension (A)	2.90 in	2.90 in	2.90 in	2.90 in
Dimension (B)	4.95 in	4.95 in	4.95 in	4.95 in
Weight	15.0 lb's	15.0 lb's	15.0 lb's	15.0 lb's
Lead Lengths	12 "	12 "	12 "	12 "
Capacitor Requirement				
Microfarads	38.0 uf	38.0 uf	38.0 uf	38.0 uf
Volts (Min)	330 V	330 V	330 V	330 V



Capacitor:	ACG312	Ignitor:	BVS-041
Microfarads:	38.0 uf	Case Temp (Max):	105 °C
Volts (Max):	330 V	BTL Distance (Max)	2 ft
Case Temp (Max)	100 °C		
Height (Max):	4.80 in		
Dia (Max):	1.80 in		
Oval Width (Max):			

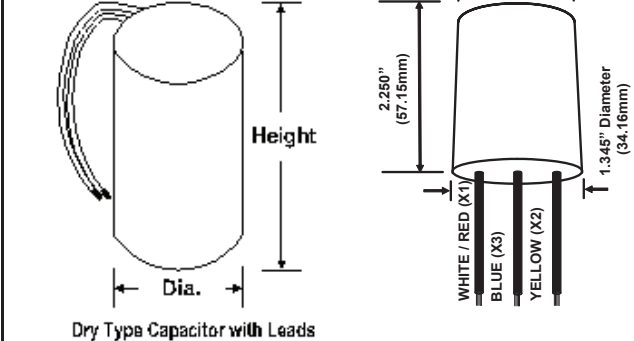

Ordering Information Add Suffix for options
 C - With Dry Capacitor
 CB - With Dry Capacitor and Welded Bracket
 B - With Welded Bracket, no Capacitor
 K - Prewired, with Dry Capacitor and Bracket Kit

* -40°F/-40°C Min Ambient Starting Temp with Venture Lamp

Data is based upon tests performed by Venture Lighting in a controlled environment and is representative of relative performance. Actual performance can vary depending on operating conditions. Specifications are subject to change without notice.

04/21/2020 **Production** Coil Material (PRI/SEC): Al / Cu

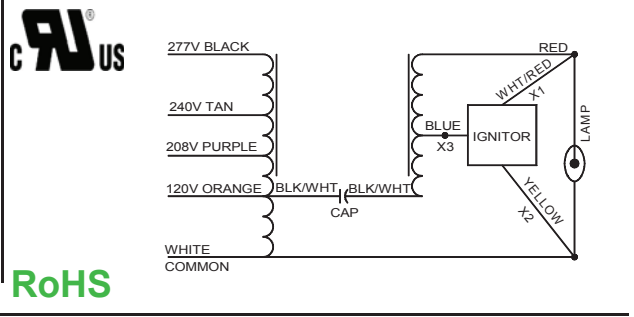

RoHS