



VERT : SITE LIGHTING PLATFORM

DESCRIPTION

VERT fixtures are cost-effective multi-use site and area lights. Available in multiple lumen packages with precision optics and flexible mounting options for a variety of outdoor applications. Additional options allow endless configurations for unmatched flexibility.

FEATURES

- Modern, low-profile design
- Easy installation
- Multiple mounting options available for versatile use
- Polycarbonate TIR optics

LISTINGS

- UL Listed for wet locations
- IP65 Rated
- DesignLights Consortium® Premium Qualified - meets the requirements for the highest DLC qualification for efficacy and lumen maintenance
- 3G Rated per ANSI C136.31

PERFORMANCE

- Rated lifetime L70: 60,000 hours
- 4000K, 5000K CCT
- CRI: 70+

ELECTRICAL

- Input voltage: 100-277V; 200-480V
- 0-10V dimming
- Power Factor: >.9
- THD: <20%

THERMAL

- -40°F up to 122°F (-40°C up to 50°C) operating temperature

CONSTRUCTION

- Diecast aluminum body with durable powder coat finish
- UV stabilized polycarbonate lens
- Stainless steel hardware

WARRANTY

- 5 year limited warranty; see eiko.com for warranty details

project name	type
catalog number	
comments	voltage
approved by	date

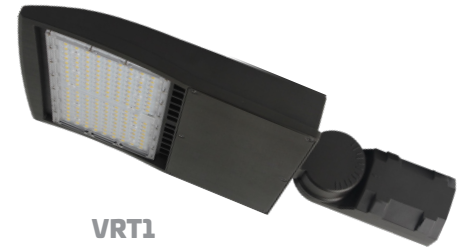

VRT1



VRT2

APPLICATIONS

- Parking Areas
- Automotive Dealerships
- Roadways
- Campuses
- Streetscapes
- Airports
- Area security lighting
- Building facades
- Signs
- Entryways



ORDERING INFORMATION

EXAMPLE: VRT1-130/C5/740-U-D-T3-BZ (item) + VRT-S-BZ (mount)
(Mount required to order)

Base Item								Mount (Required)
Model	Package	Efficacy	CRI/CCT	Voltage	Dimming	Distribution	Finish	
VRT1 - Vert ≤150W	130 - 100W; 13,000 lm	C5 - ≥125lpw	740 - 70 CRI; 4000K 750 - 70 CRI; 5000K	U - 100- 277V	D - 0-10V Dimming	T3 - Type 3 T5 - Type 5	BZ - Bronze	VRT-S-BZ - Slipfitter, 2-3/8", Bronze VRT-D-BZ - Direct Mount, Bronze VRT-Y-BZ - Yoke Mount, Bronze
	195 - 150W; 19,500 lm			V - 200- 480V			<i>Custom colors available; contact EiKO for details</i>	
VRT2 - Vert ≥185W	240 - 185W; 24,000 lm							
	380 - 300W; 38,000 lm							

PERFORMANCE SUMMARY

Order Code	Item #	Watts	Lumens	CCT	CRI	Volts	DLC
10137	VRT1-130/C5/740-U-D-T3-BZ	100W	13,000	4000K	70+	100-277V	✓✓
10150	VRT1-130/C5/740-U-D-T5-BZ	100W	13,000	4000K	70+	100-277V	✓✓
10138	VRT1-130/C5/750-U-D-T3-BZ	100W	13,000	5000K	70+	100-277V	✓✓
10151	VRT1-130/C5/750-U-D-T5-BZ	100W	13,000	5000K	70+	100-277V	✓✓
10139	VRT1-195/C5/740-U-D-T3-BZ	150W	19,500	4000K	70+	100-277V	✓✓
10152	VRT1-195/C5/740-U-D-T5-BZ	150W	19,500	4000K	70+	100-277V	✓✓
10141	VRT1-195/C5/740-V-D-T3-BZ	150W	19,500	4000K	70+	200-480V	✓✓
10154	VRT1-195/C5/740-V-D-T5-BZ	150W	19,500	4000K	70+	200-480V	✓✓
10140	VRT1-195/C5/750-U-D-T3-BZ	150W	19,500	5000K	70+	100-277V	✓✓
10153	VRT1-195/C5/750-U-D-T5-BZ	150W	19,500	5000K	70+	100-277V	✓✓
10142	VRT1-195/C5/750-V-D-T3-BZ	150W	19,500	5000K	70+	200-480V	✓✓
10155	VRT1-195/C5/750-V-D-T5-BZ	150W	19,500	5000K	70+	200-480V	✓✓
10143	VRT2-240/C5/740-U-D-T3-BZ	185W	24,000	4000K	70+	100-277V	✓✓
10156	VRT2-240/C5/740-U-D-T5-BZ	185W	24,000	4000K	70+	100-277V	✓✓
10144	VRT2-240/C5/750-U-D-T3-BZ	185W	24,000	5000K	70+	100-277V	✓✓
10157	VRT2-240/C5/750-U-D-T5-BZ	185W	24,000	5000K	70+	100-277V	✓✓
10145	VRT2-380/C5/740-U-D-T3-BZ	300W	38,000	4000K	70+	100-277V	✓✓
10158	VRT2-380/C5/740-U-D-T5-BZ	300W	38,000	4000K	70+	100-277V	✓✓
10148	VRT2-380/C5/740-V-D-T3-BZ	300W	38,000	4000K	70+	200-480V	✓✓
10160	VRT2-380/C5/740-V-D-T5-BZ	300W	38,000	4000K	70+	200-480V	✓✓
10147	VRT2-380/C5/750-U-D-T3-BZ	300W	38,000	5000K	70+	100-277V	✓✓
10159	VRT2-380/C5/750-U-D-T5-BZ	300W	38,000	5000K	70+	100-277V	✓✓
10149	VRT2-380/C5/750-V-D-T3-BZ	300W	38,000	5000K	70+	200-480V	✓✓
10161	VRT2-380/C5/750-V-D-T5-BZ	300W	38,000	5000K	70+	200-480V	✓✓

MOUNTING OPTIONS (Must be ordered with fixture)

10162	VRT-S-BZ	Slipfitter Mount for VERT, 2 3/8", Bronze
10135	VRT-D-BZ	Direct Mount for VERT, Bronze
10134	VRT-Y-BZ	Yoke Mount for VERT, Bronze

✓✓DesignLights Consortium® Premium Qualified

CONFIGURATIONS (Mounts ordered separately and field installed)

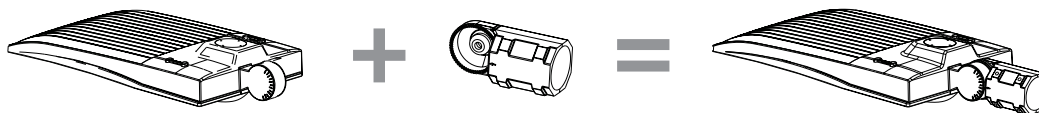

Slipfitter Mount

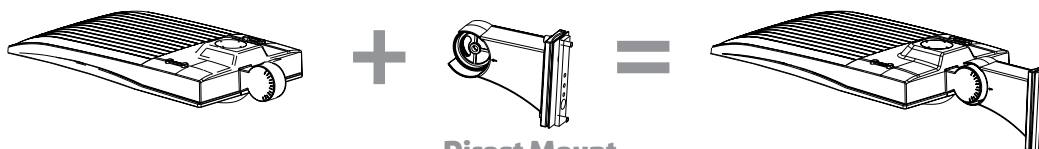

Direct Mount

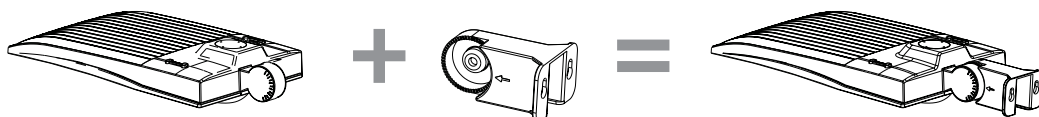

Yoke Mount

PHOTOMETRICS

VRT1-130/C5/7XX-U-D-T3-BZ

ZONAL LUMEN SUMMARY		
Zone	Lumens	%Fixture
0-30	2504.3	19.6%
0-40	4290.2	33.6%
0-60	8758.1	68.5%
60-90	3985.5	31.2%
70-100	1849.3	14.5%
90-120	23.7	0.2%
0-90	12743.6	99.7%
90-180	39.8	0.3%
0-180	12783.5	100%

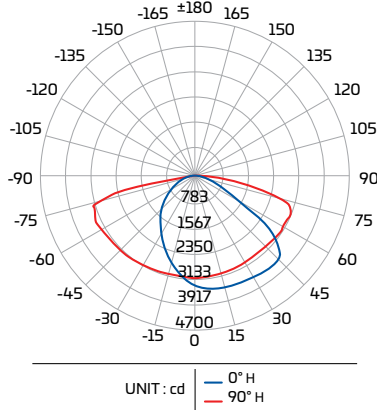

VRT2-380/C5/7XX-U-D-T3-BZ

ZONAL LUMEN SUMMARY		
Zone	Lumens	%Fixture
0-30	7737.4	20%
0-40	13194.8	34.1%
0-60	26630.5	68.9%
60-90	11926.4	30.8%
70-100	5671.7	14.7%
90-120	63.8	0.2%
0-90	38556.8	99.7%
90-180	106.8	0.3%
0-180	38663.7	100%

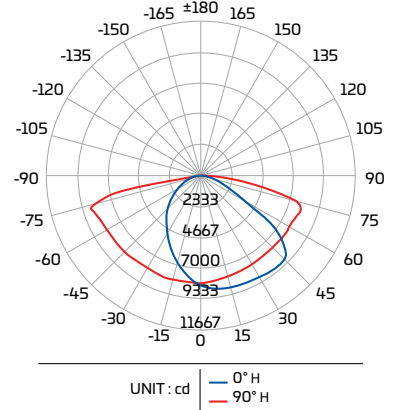

VRT1-130/C5/7XX-U-D-T5-BZ

ZONAL LUMEN SUMMARY		
Zone	Lumens	%Fixture
0-30	654.4	5.1%
30-60	2404.3	18.9%
60-80	2738.7	21.5%
80-90	378.9	3.0%
0-30	669.1	5.2%
30-60	2530.4	19.8%
60-80	2864.9	22.5%
80-90	457.6	3.6%
90-100	18.2	0.1%
100-180	38.5	0.3%

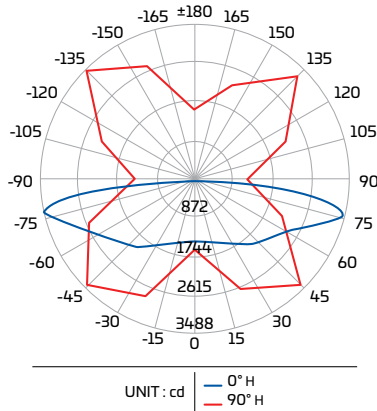

VRT2-380/C5/7XX-U-D-T5-BZ

ZONAL LUMEN SUMMARY		
Zone	Lumens	%Fixture
0-30	1943.1	5.1%
30-60	7050.1	18.4%
60-80	8203.0	21.5%
80-90	1190.1	3.1%
0-30	2039.3	5.3%
30-60	7777.3	20.3%
60-80	8660.0	22.7%
80-90	1227.7	3.2%
90-100	45.1	0.1%
100-180	86.3	0.2%

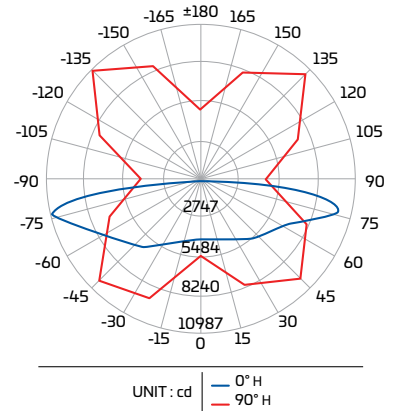

MOUNTING CONFIGURATIONS

S Single
EPA: 0.8
Weight: 12.9 lbs.

D90 Double 90°
EPA: 0.98
Weight: 24.8 lbs.

D180 Double 180°
EPA: 1.5
Weight: 24.8 lbs.

T90 Triple 90°
EPA: 1.55
Weight: 36.7 lbs.

Q90 Quad 90°
EPA: 1.55
Weight: 48.6 lbs.

VRT1

S Single
EPA: 1.1
Weight: 18.6 lbs.

D90 Double 90°
EPA: 1.28
Weight: 36.2 lbs.

D180 Double 180°
EPA: 1.9
Weight: 36.2 lbs.

T90 Triple 90°
EPA: 2.0
Weight: 53.8 lbs.

Q90 Quad 90°
EPA: 2.0
Weight: 69.8 lbs.

VRT2

DIMENSIONS

Slipfitter Mount

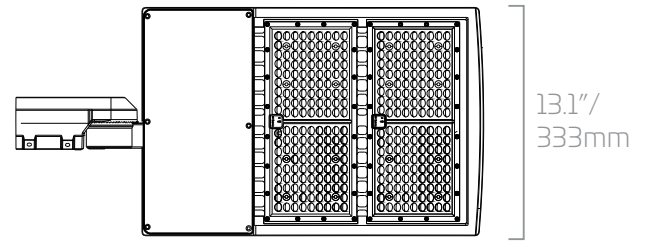
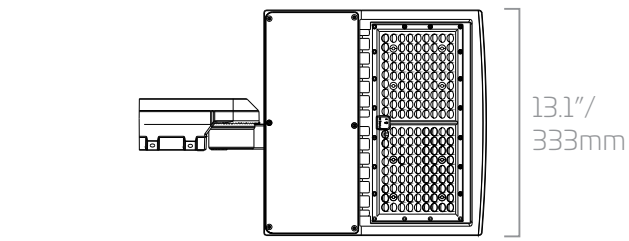

Yoke Mount

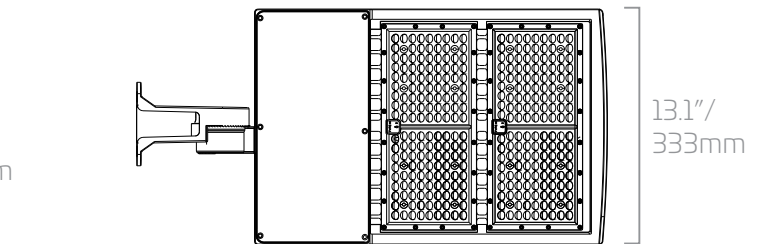
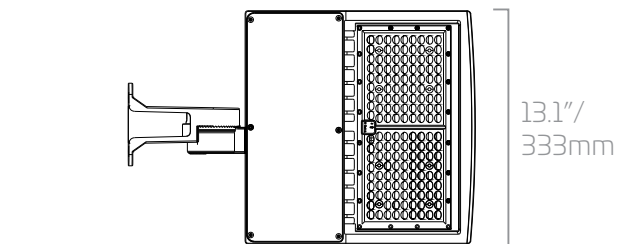

Direct Mount

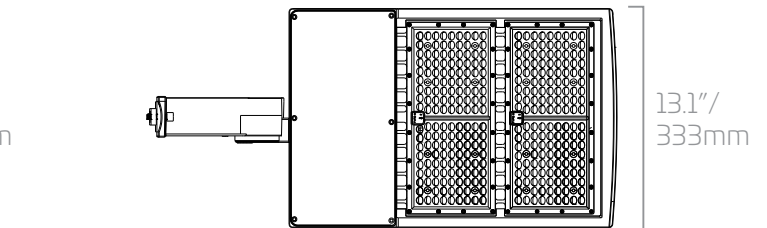
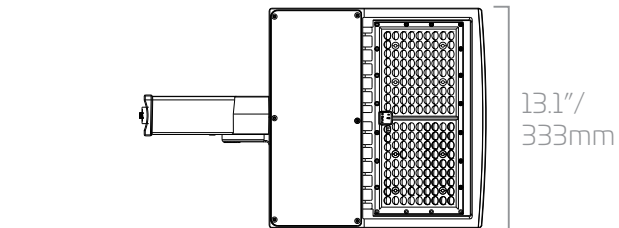

MOUNT DIMENSIONS

Slipfitter Mount

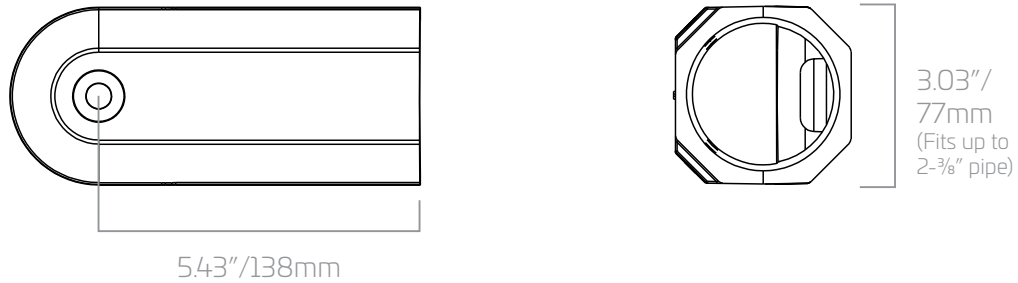

Yoke Mount

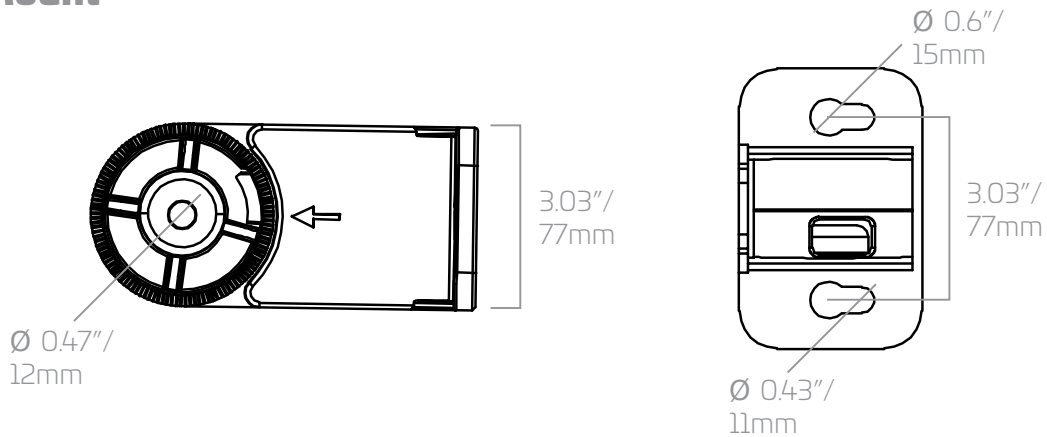

Direct Mount

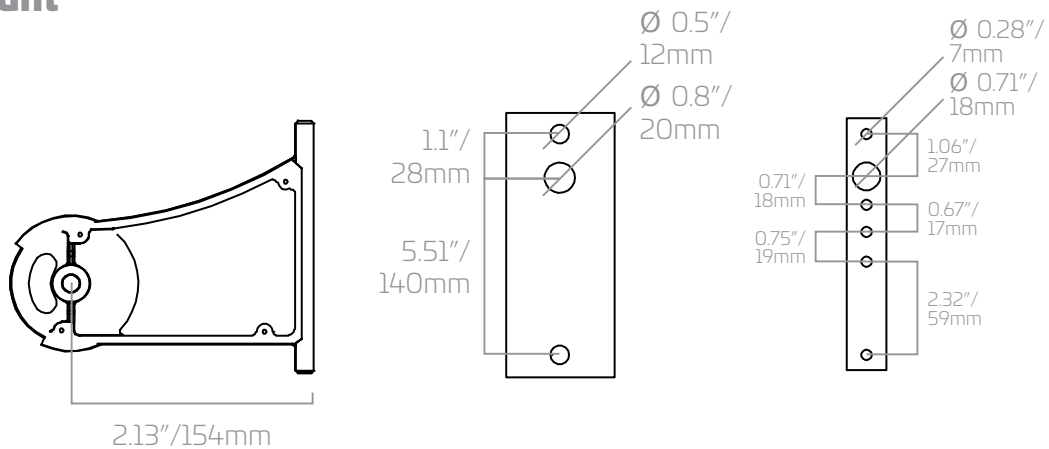

More information
available at:
eiko.com/page/vert

