

Description

Venture Lighting's Defender Wallpack luminaires are low profile, light weight, and designed for long life with low maintenance and great performance. These LED luminaires are designed to quickly and easily upgrade existing wall pack fixtures.

Construction

Rugged die cast housing finished in a durable powder coat finish and with vandal resistant polycarbonate lens. The high performance LED sources are mounted to ensure proper thermal management of the system. The design allows for a cooler running LED chip which leads to longer lifetime, better efficacy, and color consistency and sealed to eliminate the threat of contaminants damaging the components. The standard fixture color is bronze, custom colors available upon request.

Electrical

The power supply has a range of 120-277V, 50/60 Hz. 0-10V DC dimming capability is standard. The luminaires are rated for wet locations. Button photocell accessory can easily be mounted into the fixture.

Mounting

Each fixture is shipped with a quick mount plate to allow for easy installation to a recessed junction box.

DLC Model# WPA-81CEA

Product Performance

Wattage	81W
Lumen Output	9525
Correlated Color Temperature (CCT)	5000K
Color Rendering Index (CRI)	80+
Lumen Maintenance @50,000 hours*	93%
Calculated L70 @ 25°C Ambient in Hours*	250,000
Replaces HID Wattage	400W
Operating Temperature Range	-40°F to 104°F (-40°C to 40°C)

Physical Characteristics

Fixture Color	Bronze
Weight	9.6 lbs
Width	12.1"
Length	8.1"
Height	6.1"

Electrical Characteristics

Amperage Draw (Input Volts/Amps)	120/0.69 208/0.40 240/0.35 277/0.31
Surge Protection	10kA

Regulatory Qualifications

cULus Listed
DLC Qualified - Model# WPA-81CEA
Lighting Facts Qualified
Rated for wet locations

Accessories

PH56903 Button Photocell (120-277V)
AC16712 BACK PLATE, 81W DEFENDER WALLPACK - BRONZE
SP12714 - 120-277V Surge Protector

NOTE:

*Lumen maintenance data is based on LED testing per IESNA LM-80-08 and projected per IESNA TM-21-11



Venture Defender - 81W LED Wallpack

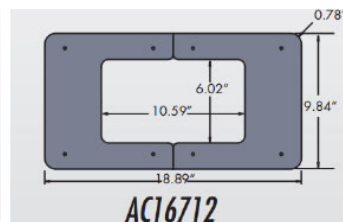
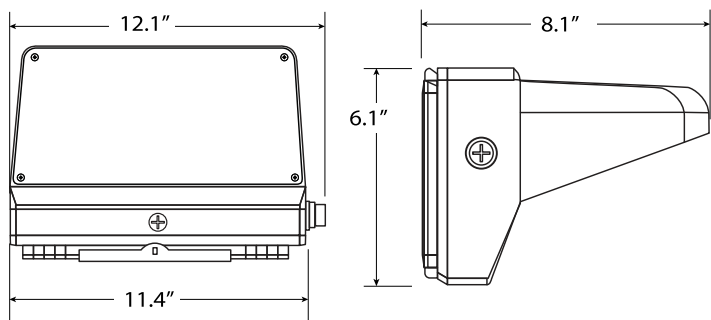

Accessories

81W

12 ft.
Height

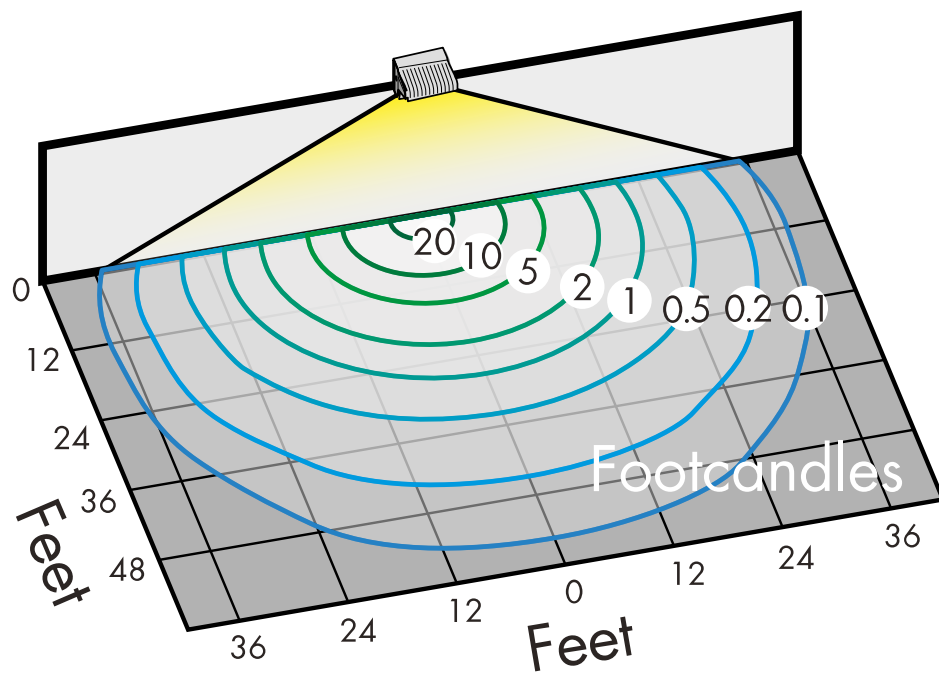

BUG Rating B3-U3-G2

