

Xd24

MID-HIGH OUTPUT | 3-IN TRACKHEAD FIXTURE

PROJECT _____

TYPE _____

SPECIFICATION _____

- 120 V
 - 50,000 hours (L70)
 - Integrated driver
 - 360° rotation; 0-90° head tilt
 - UL certified for dry locations
 - DesignLights Consortium® Certification (DLC) options
 - RoHs-compliant
 - Power on/off switch on adapters
 - Triac and ELV dimming; compatibility list available
 - Various mounting options
 - J-type, L-type, H-type: 1-circuit=1-neutral; Low profile adapter
 - G-type: 2-circuit=2-neutral; Compatible with Nordic TEK
 - Gx-type*: 3-circuit=1-neutral; Compatible with XTS, XTSC, GNC7, Hoffmeister, EUTRAC, iGuzzini, Zumtobel, ERCO
 - VioLight and MonoWhite* color rendering enhancements available
 - * 90+ High CRI available.
- To order, replace 'K' in CCT designation with 'h' in code below



Ordering Information

Example: Xd24/25/30K/2000/WH/J/SN

Fixture	Beam Spread	CCT / Lumens	Exterior Finish	Mounting	Options
Xd24	COB-optic	25K* / 1400	WH - White	J	HL - Honeycomb Louver
	15c	27K / 1550	BK - Black	L	SL - Linear Spread
	25c	30K / 1600	SV - Silver	H	SP - Prismatic Spread
	40c	30m* / 1600	PW* - Perfect White	G	SS - Solite Spread
		35K* / 1600		Gx*	SF - Frosted Spread
		35m* / 1600			More Accessories Available
		40K* / 1600			
		25K* / 2000			
		27K / 2000			
		30K / 2000			
		30m* / 2000			
		35K* / 2000			
		35m* / 2000			
		40K* / 2000			
	Multi-optic	30v / 1850			
	15	27K / 2300			
	25	30K / 2400			
	40	35K* / 2400			
		40K* / 2400			
		27K / 3000			
		30K / 3000			
		35K* / 3000			
		40K* / 3000			

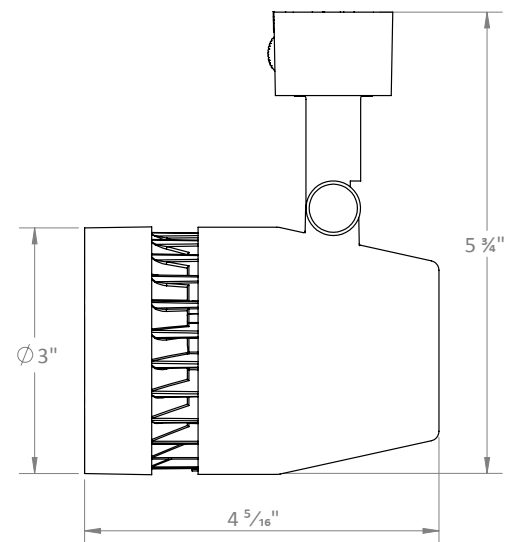

Weight: 12.8 oz.

*Consult factory for lead time and availability

Xd24

MID-HIGH OUTPUT | 3-IN TRACKHEAD FIXTURE

PROJECT _____

TYPE _____

SPECIFICATION _____

PHOTOMETRIC DETAILS | baseline X output multiplier X cri-cct multiplier = final output

COB OPTIC: Baseline data for 22 W, 2000 lumens, 80+ CRI, 3000K

Xd24/15c/30K/2000

Input Power: 22.5 W
Lumens: 1868 lm
Efficacy: 82.9 lm/W
Beam Angle: 19.2°
Field Angle: 49.1°

Xd24/25c/30K/2000

Input Power: 21.9 W
Lumens: 2200 lm
Efficacy: 100.3 lm/W
Beam Angle: 23.9°
Field Angle: 59.8°

Xd24/40c/30K/2000

Input Power: 22.2 W
Lumens: 2013 lm
Efficacy: 90.9 lm/W
Beam Angle: 38.8°
Field Angle: 85.9°

∠	0°	45°	90°
0°	7831	7831	7831
5°	6438	6425	6339
10°	3671	3628	3524
15°	1830	1823	1789
20°	1088	1090	1069
25°	726	736	709
30°	501	516	496
35°	342	353	344
40°	233	238	236
45°	157	160	163

∠	0°	45°	90°
0°	6529	6529	6529
5°	5797	5759	5621
10°	4014	3962	3803
15°	2347	2286	2202
20°	1369	1344	1311
25°	904	894	874
30°	646	642	628
35°	458	465	453
40°	332	341	331
45°	241	250	242

∠	0°	45°	90°
0°	3023	3023	3023
5°	2893	2871	2848
10°	2530	2476	2437
15°	2026	1961	1911
20°	1511	1447	1402
25°	1073	1023	987
30°	749	716	690
35°	527	507	491
40°	380	368	357
45°	278	271	263

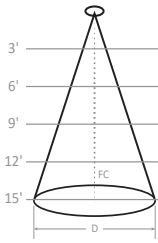

3'	1.01' D; 609 FC	1.27' D; 508 FC	2.11' D; 235 FC
6'	2.03' D; 152 FC	2.53 D; 127 FC	4.23' D; 59 FC
9'	3.04' D; 68 FC	3.80' D; 56 FC	6.34' D; 26 FC
12'	4.06' D; 38 FC	5.07' D; 32 FC	8.45' D; 15 FC
15'	5.07' D; 24 FC	6.34' D; 20 FC	10.56' D; 9 FC

OUTPUT MULTIPLIER

Package	Optic	Multiplier
18 W 1600 lm Xd24 COB	15°	0.80
	25°	0.80
	40°	0.79

CRI-CCT MULTIPLIER

CRI	CCT	Multiplier
8 (80+)	2200K	0.86
	2500K	0.91
	2700K	0.96
	3000K	1.00
	3500K	1.03
9 (90+)	4000K	1.05
	2200K	0.70
	2500K	0.77
	2700K	0.83
M (MonoWhite)	3000K	0.86
	3500K	0.88
	V (VioLight)	3000K

MULTI-OPTIC: Baseline data for 26 W, 2400 lumens, 80+ CRI, 3000K

Xd24/15/30K/2400

Input Power: 26.4 W
Lumens: 2636 lm
Efficacy: 100.0 lm/W
Beam Angle: 14.8°
Field Angle: 26.1°

Xd24/25/30K/2400

Input Power: 26.4 W
Lumens: 2573 lm
Efficacy: 97.4 lm/W
Beam Angle: 27.2°
Field Angle: 48.4°

Xd24/40/30K/2400

Input Power: 26.4 W
Lumens: 2385 lm
Efficacy: 90.5 lm/W
Beam Angle: 44.0°
Field Angle: 71.7°

∠	0°	45°	90°
0°	32012	32012	32012
5°	23079	22740	22414
10°	7807	8170	8147
15°	1905	1732	1527
20°	642	512	463
25°	268	253	255
30°	157	151	150
35°	99	91	89
40°	72	66	62
45°	55	52	51

∠	0°	45°	90°
0°	9977	9977	9977
5°	9134	9161	9195
10°	6880	6928	6963
15°	4125	4130	4112
20°	1967	1951	1931
25°	824	797	783
30°	367	340	323
35°	191	172	164
40°	111	103	99
45°	69	68	67

∠	0°	45°	90°
0°	4057	4057	4057
5°	4083	3943	3829
10°	3913	3706	3506
15°	3452	3328	3021
20°	2599	2596	2302
25°	1651	1710	1532
30°	913	969	889
35°	456	488	459
40°	221	238	225
45°	112	112	103

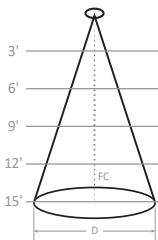

3'	0.78' D; 2490 FC	1.45' D; 776 FC	2.42' D; 316 FC
6'	1.56' D; 623 FC	2.90 D; 194 FC	4.84' D; 79 FC
9'	2.34' D; 277 FC	4.35' D; 86 FC	7.26' D; 35 FC
12'	3.12' D; 156 FC	5.81' D; 49 FC	9.68' D; 20 FC
15'	3.90' D; 100 FC	7.26' D; 31 FC	12.11' D; 13 FC

OUTPUT MULTIPLIER

Package	Optic	Multiplier
20 W 1850 lm Xd24 Multi-optic	15°	0.70
	25°	0.72
	40°	0.78

Package	Optic	Multiplier
28 W 3000 lm Xd24 Multi-optic	15°	1.13
	25°	1.17
	40°	1.12

Xd24

MID-HIGH OUTPUT | 3-IN TRACKHEAD FIXTURE

TM30 COLOR REPORTS

- 3000K with 80+ CRI
- $R_f = 84$; $R_g = 94$
- $R_A = 82$; $R_9 = 11$

- 3000K with 90+ CRI
- $R_f = 92$; $R_g = 100$
- $R_A = 93$; $R_9 = 56$

- 3000K with 97+ CRI
- $R_f = 96$; $R_g = 104$
- $R_A = 97$; $R_9 = 98$

- 3000K with MonoWhite
- $R_f = 91$; $R_g = 100$
- $R_A = 91$; $R_9 = 42$

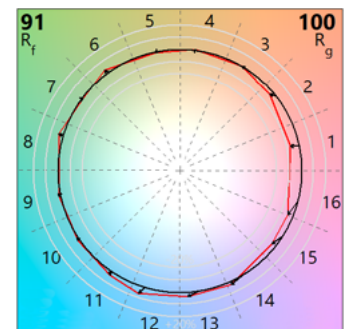
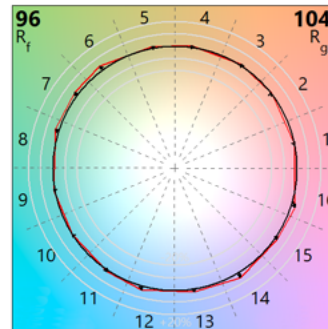
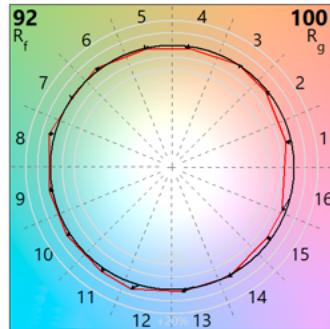
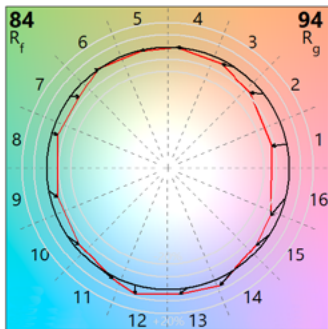
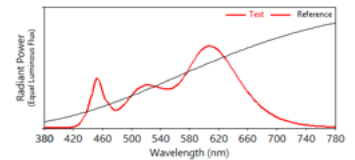
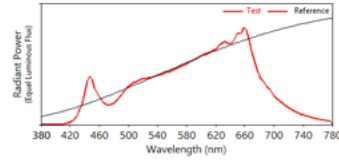
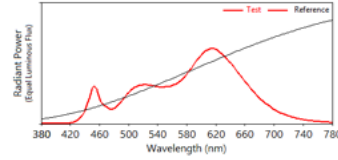
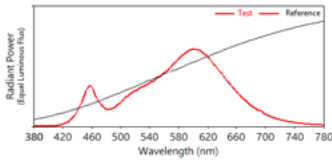

Luxiance utilizes active cooling to remove heat from the LED system - allowing Solais LED lamps to operate cooler, resulting in superior life, light output, and performance.



Thermal Throttle – In the event that Solais products begin to overheat, they will undetectably dim unthemselves to protect your technology investments.

WARNING: Not for use in fully enclosed luminaires. Risk of electric shock. Use in an indoor, dry location only. This device is not intended for use with emergency exit fixtures or emergency exit lights. May not be compatible with all dimmers; please visit solais.com/dimming for up-to-date dimmer compatibility information.

NOTES: This device complies with Part 15 of the FCC Rule. This product may cause interference with other devices. If interference occurs, change the locations of the products involved. **Compatible on 120v systems.**



VioLight radiates superior quality, enhancing colors in merchandise, making colors more vibrant and offering a truly competitive LED replacement for CMH-like crispness.